

# Oracle® Database

## Data Cartridge Developer's Guide



18c  
E84275-01  
February 2018

The Oracle logo, consisting of a solid red square with the word "ORACLE" in white, uppercase, sans-serif font centered within it.

ORACLE®

Oracle Database Data Cartridge Developer's Guide, 18c

E84275-01

Copyright © 1996, 2018, Oracle and/or its affiliates. All rights reserved.

Primary Authors: Prashant Kannan, Preethy P G, Tulika Das

Contributing Authors: Eric Belden, Timothy Chorma, Dinesh Das, Janis Greenberg, Ying Hu, Susan Kotsovolos, Geoff Lee, Roza Leyderman, Susan Mavris, Valarie Moore, Magdi Morsi, Chuck Murray, Den Raphaely, Helen Slattery, Seema Sundara

This software and related documentation are provided under a license agreement containing restrictions on use and disclosure and are protected by intellectual property laws. Except as expressly permitted in your license agreement or allowed by law, you may not use, copy, reproduce, translate, broadcast, modify, license, transmit, distribute, exhibit, perform, publish, or display any part, in any form, or by any means. Reverse engineering, disassembly, or decompilation of this software, unless required by law for interoperability, is prohibited.

The information contained herein is subject to change without notice and is not warranted to be error-free. If you find any errors, please report them to us in writing.

If this is software or related documentation that is delivered to the U.S. Government or anyone licensing it on behalf of the U.S. Government, then the following notice is applicable:

U.S. GOVERNMENT END USERS: Oracle programs, including any operating system, integrated software, any programs installed on the hardware, and/or documentation, delivered to U.S. Government end users are "commercial computer software" pursuant to the applicable Federal Acquisition Regulation and agency-specific supplemental regulations. As such, use, duplication, disclosure, modification, and adaptation of the programs, including any operating system, integrated software, any programs installed on the hardware, and/or documentation, shall be subject to license terms and license restrictions applicable to the programs. No other rights are granted to the U.S. Government.

This software or hardware is developed for general use in a variety of information management applications. It is not developed or intended for use in any inherently dangerous applications, including applications that may create a risk of personal injury. If you use this software or hardware in dangerous applications, then you shall be responsible to take all appropriate fail-safe, backup, redundancy, and other measures to ensure its safe use. Oracle Corporation and its affiliates disclaim any liability for any damages caused by use of this software or hardware in dangerous applications.

Oracle and Java are registered trademarks of Oracle and/or its affiliates. Other names may be trademarks of their respective owners.

Intel and Intel Xeon are trademarks or registered trademarks of Intel Corporation. All SPARC trademarks are used under license and are trademarks or registered trademarks of SPARC International, Inc. AMD, Opteron, the AMD logo, and the AMD Opteron logo are trademarks or registered trademarks of Advanced Micro Devices. UNIX is a registered trademark of The Open Group.

This software or hardware and documentation may provide access to or information about content, products, and services from third parties. Oracle Corporation and its affiliates are not responsible for and expressly disclaim all warranties of any kind with respect to third-party content, products, and services unless otherwise set forth in an applicable agreement between you and Oracle. Oracle Corporation and its affiliates will not be responsible for any loss, costs, or damages incurred due to your access to or use of third-party content, products, or services, except as set forth in an applicable agreement between you and Oracle.

# Contents

## Preface

---

Audience	xxiv
Documentation Accessibility	xxiv
Conventions	xxiv

## Changes in This Release for Oracle Database Data Cartridge Developer's Guide

---

Changes in Oracle Database 18c, Version 18.1	xxv
--	-----

## Part I Introduction

---

### 1 Introduction to Data Cartridges

---

1.1 Overview of Data Cartridges	1-1
1.2 Uses of Data Cartridges	1-2
1.2.1 Data Cartridge Domains	1-2
1.3 Extending the Server: Services and Interfaces	1-3
1.3.1 Extensibility Services	1-4
1.3.1.1 Extensible Type System	1-4
1.3.1.2 Extensible Server Execution Environment	1-6
1.3.1.3 Extensible Indexing	1-7
1.3.1.4 Extensible Optimizer	1-8
1.3.2 Extensibility Interfaces	1-9

### 2 Roadmap to Building a Data Cartridge

---

2.1 Data Cartridge Development Process	2-1
2.1.1 Implement the Project	2-1
2.2 Installing and Using Data Cartridges	2-3
2.3 Requirements and Guidelines for Data Cartridge Components	2-4
2.3.1 Cartridge Schemas	2-4

2.3.2	Cartridge Globals	2-4
2.3.3	Cartridge Error Message Names or Error Codes	2-4
2.3.4	Cartridge Installation Directory	2-5
2.3.5	Cartridge Files	2-5
2.3.6	Shared Library Names for External Procedures	2-5
2.4	Data Cartridge Deployment	2-5
2.4.1	Data Cartridge Naming Conventions	2-6
2.4.1.1	Need for Naming Conventions in Data Cartridges	2-6
2.4.1.2	Unique Name Format	2-6
2.4.1.3	Data Cartridge Naming Conventions	2-7
2.4.2	Cartridge Registration	2-8
2.4.3	Cartridge Directory Structure and Standards	2-8
2.4.4	Cartridge Upgrades	2-8
2.4.5	Import and Export of Cartridge Objects	2-8
2.4.6	Cartridge Versioning	2-8
2.4.7	Cartridge Internationalization	2-9
2.4.8	Cartridge Administration	2-9
2.4.9	Data Cartridge Development Approach	2-10
2.4.9.1	Creating a Data Cartridge Plan	2-10
2.4.9.2	Developing Data Cartridges	2-10

## Part II Building Data Cartridges

---

### 3 Defining Object Types for Data Cartridges

---

3.1	Objects and Object Types for Data Cartridges	3-1
3.1.1	Defining a DataStream Data Type	3-2
3.1.2	Defining the Type Body	3-2
3.2	Assigning an Object Identifier to an Object Type in Data Cartridges	3-2
3.2.1	Specifying an ODI for an Object Type in Data Cartridges	3-3
3.2.2	Assigning and Using OIDs in Data Cartridges	3-3
3.3	Constructor Methods in Data Cartridges	3-3
3.3.1	Creating a Type	3-4
3.3.2	Instantiating a Type Object	3-4
3.4	Object Comparison in Data Cartridges	3-4
3.4.1	Implementing a Member Function	3-4
3.4.2	Implementing Functions for Types Without a Simple Id Attribute	3-5

### 4 Implementing Data Cartridges in PL/SQL

---

4.1	Methods	4-1
-----	---------	-----

4.1.1	Implementing Methods	4-1
4.1.1.1	Defining an Object Type	4-1
4.1.1.2	Defining a “Greatest Common Divisor” Function	4-2
4.1.1.3	Implementing Methods for an Object Type	4-2
4.1.2	Invoking Methods	4-3
4.1.2.1	General Syntax for Invoking Methods	4-3
4.1.2.2	SQL Syntax for Invoking Methods	4-3
4.1.2.3	PL/SQL Syntax for Invoking Methods	4-3
4.1.2.4	Using the SELF Build-In Parameter	4-3
4.1.3	Referencing Attributes in a Method	4-4
4.1.3.1	Setting Variable Values	4-4
4.2	Debugging PL/SQL Code	4-4
4.2.1	Notes for C and C++ Developers of Data Cartridges	4-5
4.2.2	Common Potential Errors	4-5
4.2.2.1	Signature Mismatches	4-5
4.2.2.2	RPC Time Out	4-6
4.2.2.3	Package Corruption	4-6

## 5 Implementing Data Cartridges in C, C++, and Java

---

5.1	Shared Libraries	5-1
5.1.1	Using Shared Libraries	5-1
5.1.1.1	Creating an Alias Library	5-2
5.1.1.2	Specifying the Location of the Library	5-2
5.1.1.3	Creating an Alias Library through Directory Objects	5-2
5.2	External Procedures	5-2
5.2.1	Registering an External Procedure	5-3
5.2.1.1	Defining the Body of a Package	5-4
5.3	How PL/SQL Calls an External Procedure	5-4
5.4	Configuring Files for External Procedures	5-5
5.4.1	Updating the Listener Configuration File	5-5
5.4.2	Directing Network to Refer to External Procedures	5-6
5.4.3	Passing Parameters to an External Procedure	5-6
5.4.4	Specifying Data Types	5-6
5.4.4.1	Conversion to External Datatypes	5-7
5.4.4.2	Conversion from External Datatypes	5-7
5.4.5	Using the Parameters Clause	5-8
5.4.6	Using the WITH CONTEXT Clause	5-9
5.5	Using Callbacks	5-9
5.5.1	Restrictions on Callbacks	5-10
5.6	Common Potential Errors	5-10

5.6.1	Calls to External Functions	5-10
5.6.2	RPC Time Out	5-11
5.7	Debugging External Procedures	5-11
5.7.1	Using Package DEBUG_EXTPROC	5-11
5.7.2	Debugging C Code in DLLs on Windows NT Systems	5-11
5.8	Guidelines for Using External Procedures with Data Cartridges	5-12
5.9	Java Methods	5-12

## 6 Working with Multimedia Data Types

---

6.1	Overview of Cartridges and Multimedia Data Types	6-1
6.2	Using DDL for LOBs	6-1
6.2.1	Creating a LOB Attribute of a Type	6-2
6.2.2	Creating a LOB Object Table	6-2
6.2.3	Creating LOB Columns	6-2
6.3	LOB Locators	6-2
6.3.1	Selecting a LOBs and Assigning it to a Local Variable	6-3
6.3.2	Manipulating LOBs	6-3
6.4	Emptying LOBs	6-3
6.4.1	Using EMPTY_BLOB() in SQL	6-4
6.4.2	Using EMPTY_CLOB() in PL/SQL	6-4
6.5	Using the OCI to Manipulate LOBs	6-4
6.5.1	OCI Functions for Manipulating LOBs	6-5
6.5.2	Comparing OCI and PL/SQL Interfaces	6-6
6.5.3	Selecting a Stored LOB into a Locator	6-7
6.6	Using DBMS_LOB Package to Manipulate LOBs	6-9
6.6.1	DBMS_LOB Package Routines	6-9
6.6.2	Trimming a CLOB	6-10
6.7	LOBs in External Procedures	6-10
6.7.1	Defining an External Procedure (PL/SQL)	6-11
6.8	LOBs and Triggers	6-11
6.9	Using Open/Close as Bracketing Operations for Efficient Performance	6-11
6.9.1	Errors and Restrictions Regarding Open/Close Operations	6-12
6.9.1.1	Working with Open() and Close() Code Blocks	6-12

## 7 Using Extensible Indexing

---

7.1	Overview of Extensible Indexing	7-1
7.1.1	Purpose of Indexes	7-1
7.1.2	Purpose of Extensible Indexing	7-1
7.1.3	When to Use Extensible Indexing	7-2

7.1.4	Index Structures	7-2
7.1.4.1	B-tree	7-2
7.1.4.2	Hash	7-3
7.1.4.3	k-d tree	7-4
7.1.4.4	Point Quadtree	7-4
7.2	Extensible Indexing Framework	7-5
7.3	Using the Text Indextype	7-6
7.3.1	Defining the Indextype	7-6
7.3.1.1	Non-Index-Based Functional Implementations	7-6
7.3.1.2	Index-Based Functional Implementations	7-7
7.3.2	Using the Indextype	7-8
7.3.2.1	Declaring a New Table	7-8
7.3.2.2	Building a Text Domain Index for the Table	7-8
7.3.2.3	Querying a Table Using a Contains() Operator	7-8

## 8 Building Domain Indexes

---

8.1	Overview of Indextypes and Domain Indexes	8-1
8.2	ODCIIndex Interface	8-2
8.2.1	Index Definition Methods	8-2
8.2.1.1	ODCIIndexCreate()	8-2
8.2.1.2	ODCIIndexAlter()	8-3
8.2.1.3	ODCIIndexDrop()	8-3
8.2.2	Index Maintenance Methods	8-3
8.2.2.1	ODCIIndexInsert()	8-3
8.2.2.2	ODCIIndexDelete()	8-3
8.2.2.3	ODCIIndexUpdate()	8-3
8.2.3	Index Scan Methods	8-3
8.2.3.1	ODCIIndexStart()	8-4
8.2.3.2	ODCIIndexFetch()	8-4
8.2.3.3	ODCIIndexClose()	8-5
8.2.4	Index Metadata Method	8-5
8.2.5	Transaction Semantics During Index Method Execution	8-5
8.2.6	Transaction Semantics for Index Definition Routines	8-6
8.2.7	Consistency Semantics during Index Method Execution	8-6
8.2.8	Privileges During Index Method Execution	8-6
8.3	Creating, Dropping, and Commenting Indextypes	8-7
8.3.1	Creating Indextypes	8-7
8.3.2	Dropping Indextypes	8-7
8.3.3	Commenting Indextypes	8-8
8.3.3.1	INDEXTYPE Comments	8-8

8.4	Domain Indexes	8-8
8.4.1	Domain Index Operations	8-8
8.4.1.1	Creating a Domain Index	8-9
8.4.1.2	Changing a Domain Index	8-9
8.4.1.3	Renaming a Domain Index	8-9
8.4.1.4	Rebuilding a Domain Index	8-9
8.4.1.5	Truncating a Domain Index	8-10
8.4.1.6	Dropping a Domain Index	8-10
8.4.2	Domain Indexes on Index-Organized Tables	8-10
8.4.2.1	About Rowid Storage in a UROWID Column	8-10
8.4.2.2	Determining the Size of a UROWID Column	8-11
8.4.2.3	DML on Index Storage Tables	8-11
8.4.2.4	Start, Fetch, and Close Operations on Index Storage Tables	8-11
8.4.2.5	Indexes on Non-Unique Columns	8-11
8.4.3	Domain Index Metadata	8-12
8.4.4	Moving Domain Indexes Using Export/Import	8-12
8.4.5	Moving Domain Indexes Using Transportable Tablespaces	8-12
8.4.6	Domain Index Views	8-13
8.5	Object Dependencies, Drop Semantics, and Validation	8-14
8.5.1	Object Dependencies	8-14
8.5.2	Object Drop Semantics	8-14
8.5.3	Object Validation	8-15
8.6	Indextype, Domain Index, and Operator Privileges	8-15
8.7	Partitioned Domain Indexes	8-15
8.7.1	Using Local Domain Index Methods	8-15
8.7.2	About Partitioned Indexes	8-16
8.7.3	Creating a Local Domain Index	8-16
8.7.4	Dropping a Local Domain Index	8-17
8.7.5	Altering a Local Domain Index	8-17
8.7.6	Summary of Index States	8-17
8.7.7	DML Operations with Local Domain Indexes	8-18
8.7.8	Table Operations that Affect Indexes	8-18
8.7.9	ODCIIndex Interfaces for Partitioning Domain Indexes	8-19
8.7.10	Using SQL*Loader for Domain Indexes	8-19
8.8	Using System Partitioning	8-19
8.8.1	Advantages of System Partitioned Tables	8-20
8.8.2	Implementing System Partitioning	8-20
8.8.2.1	Creating a System-Partitioned Table	8-20
8.8.2.2	Inserting Data into a System-Partitioned Table	8-20
8.8.2.3	Deleting and Updating Data in a System-Partitioned Table	8-21
8.8.3	Supporting Operations with System-Partitioned Tables	8-21



8.8.4	Running Partition Maintenance Operations	8-22
8.8.5	Altering Table Exchange Partitions with Indexes	8-22
8.9	Using System-Managed Domain Indexes	8-23
8.10	Designing System-Managed Domain Indexes	8-25
8.10.1	Methods for Non-Partitioned Domain Indexes	8-26
8.10.2	Methods for Local System-Managed Domain Indexes	8-27
8.11	Creating Local Domain Indexes	8-28
8.12	Maintaining Local Domain Indexes with INSERT, DELETE, and UPDATE	8-29
8.13	Querying Local Domain Indexes	8-30
8.14	System Managed Domain Index - Supported Schemes	8-30
8.15	Restrictions of System-Managed Domain Indexing	8-30
8.16	Migrating Non-Partitioned Indexes	8-31
8.17	Migrating Local Partitioned Indexes	8-31

## 9 Defining Operators

---

9.1	User-Defined Operators	9-1
9.1.1	Operator Bindings	9-1
9.1.2	Operator Privileges	9-2
9.1.3	Creating Operators	9-2
9.1.4	Dropping Operators	9-2
9.1.5	Altering Operators	9-2
9.1.5.1	Necessary Privileges for ALTER OPERATOR	9-3
9.1.5.2	Restrictions of ALTER OPERATOR	9-3
9.1.6	Commenting Operators	9-3
9.1.7	About Invoking Operators	9-3
9.1.7.1	Creating Contains() Operator	9-4
9.1.7.2	Using Contains() Operator in a Query	9-4
9.1.7.3	Using Contains() Operator Incorrectly	9-4
9.2	Operators and Indextypes	9-4
9.2.1	Operators in the WHERE Clause	9-5
9.2.1.1	Using Operator Predicates	9-5
9.2.1.2	Resolving Query Results with the Contains() Operator	9-5
9.2.1.3	Setting Up an Index Scan	9-6
9.2.1.4	Execution Model for Index Scan Methods	9-6
9.2.1.5	Filtering Multiple Table Queries with Contains() Operator	9-7
9.2.1.6	Invoking Indextype Routines for the Contains() Operator	9-7
9.2.2	Using Operators Outside the WHERE Clause	9-7
9.2.2.1	Creating Index-based Functional Implementations	9-7
9.2.2.2	Implementing the Contains() Operator in Index-Based Functions	9-8
9.2.2.3	Binding the Contains() Operator to the Functional Implementation	9-8

9.2.2.4	Operator Resolution	9-8
9.2.2.5	Operator Execution	9-9
9.2.3	Operators that Return Ancillary Data	9-9
9.2.3.1	Operator Bindings that Compute Ancillary Data	9-10
9.2.3.2	Operator Bindings That Model Ancillary Data	9-10
9.2.3.3	Operator Resolution	9-11
9.2.3.4	Operator Execution	9-11

## 10 Using Extensible Optimizer

---

10.1	Overview of Query Optimization	10-1
10.1.1	Statistics	10-2
10.1.1.1	User-Defined Statistics	10-2
10.1.1.2	User-Defined Statistics for Partitioned Objects	10-3
10.1.2	Selectivity	10-3
10.1.2.1	User-Defined Selectivity	10-3
10.1.3	Cost	10-4
10.1.3.1	User-Defined Cost	10-4
10.2	Defining Statistics, Selectivity, and Cost Functions	10-5
10.2.1	Defining a Statistics Type	10-6
10.2.2	User-Defined Statistics Functions	10-7
10.2.3	User-Defined Selectivity Functions	10-7
10.2.4	User-Defined Cost Functions for Functions	10-9
10.2.5	User-Defined Cost Functions for Domain Indexes	10-10
10.2.6	Generating Statistics for System-Managed Domain Indexes	10-11
10.2.6.1	Index-Partition Statistics Storage in an Index Table	10-11
10.2.6.2	Index-Partition Statistics Storage in a Separate Table	10-12
10.2.6.3	Index-Partition Statistics Storage in a Common Table	10-12
10.3	Using User-Defined Statistics, Selectivity, and Cost	10-13
10.3.1	User-Defined Statistics	10-13
10.3.1.1	Column Statistics	10-13
10.3.1.2	Implementing Domain Index Statistics	10-14
10.3.2	User-Defined Selectivity	10-15
10.3.2.1	User-Defined Operators	10-15
10.3.2.2	Standalone Functions	10-15
10.3.2.3	Package Functions	10-15
10.3.2.4	Type Methods	10-15
10.3.2.5	Default Selectivity	10-16
10.3.3	User-Defined Cost	10-16
10.3.3.1	User-Defined Operators	10-16
10.3.3.2	Standalone Functions	10-16

10.3.3.3	Package Functions	10-17
10.3.3.4	Type Methods	10-17
10.3.3.5	Default Cost	10-17
10.3.4	Declaring a NULL Association for an Index or Column	10-18
10.3.5	How DDL Operations Affect Statistics	10-18
10.4	Predicate Ordering	10-19
10.5	Dependency Model	10-19
10.6	Restrictions and Suggestions	10-20
10.6.1	Distributed Execution	10-20
10.6.2	System-Managed Storage Tables and ASSOCIATE STATISTICS	10-20
10.6.3	Aggregate Object-Level Statistics	10-21
10.6.4	System-Managed Domain Indexing	10-21
10.6.5	Collecting and Deleting User-Defined Statistics for System-Managed Indexes	10-21
10.6.5.1	Collecting statistics for a system-managed domain index	10-21
10.6.5.2	Deleting statistics for a system-managed domain index	10-22
10.6.5.3	Collecting statistics for all partitions of a local system-managed domain index	10-22
10.6.5.4	Deleting statistics for all partitions of a local system-managed domain index	10-22
10.6.5.5	Collecting statistics for partition P2 of a local system-managed domain index	10-22
10.6.5.6	Deleting statistics for partition P2 of a local system-managed domain index	10-23
10.6.5.7	Collecting statistics for all subpartitions of a composite partition of a local system-managed domain index	10-23
10.6.5.8	Deleting statistics for all subpartitions of a composite partition of a local system-managed domain index	10-23
10.6.5.9	Collecting statistics for a subpartition of a local system-managed domain index	10-24
10.6.5.10	Deleting statistics for a subpartition of a local system-managed domain index	10-24
10.6.6	Performance	10-24

## 11 Using Cartridge Services

---

11.1	Introduction to Cartridge Services	11-1
11.2	Cartridge Handle	11-2
11.2.1	Client Side Usage	11-2
11.2.2	Cartridge Side Usage	11-2
11.2.3	Making Service Calls	11-2
11.2.4	Handling Errors	11-3
11.3	Memory Services	11-3
11.4	Maintaining Context	11-4

11.4.1	Durations	11-4
11.5	Globalization Support	11-4
11.5.1	Globalization Support Language Information Retrieval	11-5
11.5.2	String Manipulation	11-5
11.6	Parameter Manager Interface	11-5
11.6.1	Input Processing and Support for Special Characters	11-5
11.6.2	Parameter Manager Behavior Flag	11-6
11.6.3	Key Registration	11-6
11.6.4	Parameter Storage and Retrieval	11-7
11.6.5	Parameter Manager Context	11-7
11.7	File I/O	11-7
11.8	String Formatting	11-7

## 12 Using User-Defined Aggregate Functions

---

12.1	Overview of User-Defined Aggregate Functions	12-1
12.1.1	Using User-Defined Aggregate Functions	12-2
12.2	Creating a User-Defined Aggregate	12-2
12.3	Using a User-Defined Aggregate	12-3
12.3.1	Using the SELECT Statement with User-Defined Aggregate Functions	12-3
12.3.2	Using the HAVING Clause with User-Defined Aggregate Functions	12-4
12.3.3	Using Query Options with User-Defined Aggregate Functions	12-4
12.4	Evaluating User-Defined Aggregates in Parallel	12-4
12.5	Handling Large Aggregation Contexts	12-5
12.5.1	External Context and Parallel Aggregation	12-6
12.5.1.1	Using External Memory to Store Aggregate Context	12-6
12.5.2	User-Defined Aggregates and Analytic Functions	12-7
12.5.2.1	Using User-Defined Aggregates and Analytic Functions	12-7
12.5.3	Reuse of Aggregation Context for Analytic Functions	12-7
12.5.4	External Context and User-Defined Analytic Functions	12-8
12.6	Using Materialized Views with User-Defined Aggregates	12-8
12.7	Creating and Using a User-Defined Aggregate Function	12-9

## 13 Using Pipelined and Parallel Table Functions

---

13.1	Overview of Table Functions	13-1
13.2	Table Function Concepts	13-2
13.2.1	Table Functions	13-2
13.2.2	Pipelined Table Functions	13-3
13.2.3	Pipelined Table Functions with REF CURSOR Arguments	13-3
13.2.4	Parallel Execution of Table Functions	13-5

13.3	Pipelined Table Functions	13-5
13.3.1	Implementation Choices for Pipelined Table Functions	13-6
13.3.2	Declaring Pipelined Table Functions	13-6
13.3.3	Implementing the Native PL/SQL Approach	13-6
13.3.4	Pipelining Between PL/SQL Table Functions	13-7
13.3.5	Combining PIPE ROW with AUTONOMOUS_TRANSACTION	13-7
13.3.6	Implementing the Interface Approach	13-8
13.3.6.1	Scan Context	13-8
13.3.6.2	Start Routine	13-9
13.3.6.3	Fetch Routine	13-9
13.3.6.4	Close Routine	13-10
13.3.6.5	Describing Returned Data Structures; Describe Method	13-10
13.3.6.6	Preparing a Query for Execution; Prepare Method	13-12
13.3.7	Querying Table Functions	13-13
13.3.7.1	Implementing Multiple Calls to Table Functions	13-13
13.3.7.2	Using PL/SQL REF CURSOR Variables	13-14
13.3.8	Performing DML Operations Inside Table Functions	13-14
13.3.9	Performing DML Operations on Table Functions	13-14
13.3.10	Handling Exceptions in Table Functions	13-15
13.4	Parallel Table Functions	13-15
13.4.1	Inputting Data with Cursor Variables	13-15
13.4.1.1	Using Multiple REF CURSOR Input Variables	13-16
13.4.1.2	Explicitly Opening a REF CURSOR for a Query	13-16
13.4.1.3	PL/SQL REF CURSOR Arguments to Java and C/C++ Functions	13-16
13.4.2	Input Data Partitioning	13-18
13.4.3	Parallel Execution of Leaf-Level Table Functions	13-20
13.5	Input Data Streaming for Table Functions	13-20
13.5.1	Setting up the Input Stream	13-21
13.5.2	Parallel Execution: Partitioning and Clustering	13-21
13.6	Creating Domain Indexes in Parallel	13-22
13.6.1	Loading Domain Indexes	13-23
13.7	Transient and Generic Types	13-23

## 14 Designing Data Cartridges

---

14.1	Choosing the Programming Language	14-1
14.2	Invoker's Rights	14-1
14.3	Callouts and LOBs	14-1
14.4	Saving and Passing State	14-2
14.5	Designing Indexes	14-2
14.5.1	Domain Index Performance	14-2

14.5.2	Domain Index Component Names	14-2
14.5.3	When to Use Index-Organized Tables	14-2
14.5.4	Storing Index Structures in LOBs	14-3
14.5.5	External Index Structures	14-3
14.5.6	Multi-Row Fetch	14-3
14.6	Designing Operators	14-4
14.7	Designing for the Extensible Optimizer	14-4
14.7.1	Weighing Cost and Selectivity	14-4
14.7.2	Cost for functions	14-4
14.7.2.1	Selectivity for Functions	14-4
14.7.2.2	Statistics for Tables	14-5
14.7.2.3	Statistics for Indexes	14-5
14.8	Designing for Maintenance	14-5
14.9	Enabling Cartridge Installation	14-5
14.10	Designing for Portability	14-6

## Part III Scenarios and Examples

---

### 15 Power Demand Cartridge Example

---

15.1	Feature Requirements	15-1
15.2	Modeling the Application	15-7
15.2.1	Sample Queries	15-8
15.3	Queries and Extensible Indexing	15-10
15.3.1	Queries Not Benefiting from Extensible Indexing	15-10
15.3.2	Queries Benefiting from Extensible Indexing	15-11
15.4	Creating the Domain Index	15-12
15.4.1	Creating the Schema to Own the Index	15-12
15.4.2	Creating the Object Types	15-12
15.4.3	Defining the Object Type Methods	15-13
15.4.4	Understanding Functions and Operators	15-14
15.4.4.1	Creating Functions and Operators	15-15
15.4.5	Creating the Indextype Implementation Methods	15-17
15.4.6	Defining theType	15-18
15.4.6.1	ODCIGetInterfaces()	15-19
15.4.6.2	ODCIIndexCreate()	15-20
15.4.6.3	ODCIIndexDrop()	15-21
15.4.6.4	ODCIIndexStart(); Specific Queries	15-22
15.4.6.5	ODCIIndexStart(); Any Queries	15-24
15.4.6.6	ODCIIndexFetch()	15-25
15.4.6.7	ODCIIndexClose()	15-26

15.4.6.8	ODCIIndexInsert()	15-27
15.4.6.9	ODCIIndexDelete()	15-28
15.4.6.10	ODCIIndexUpdate()	15-28
15.4.6.11	ODCIIndexGetMetadata()	15-30
15.4.7	Creating the Indextype	15-31
15.5	Defining Types and Methods for Extensible Optimizing	15-32
15.5.1	Creating the Statistics Table, PowerCartUserStats	15-32
15.5.2	Creating the Extensible Optimizer Methods	15-33
15.5.2.1	Creating the Type Definition	15-33
15.5.2.2	ODCIGetInterfaces()	15-35
15.5.2.3	ODCIStatsCollect() Method for PowerDemand_Typ Columns	15-35
15.5.2.4	ODCIStatsDelete() Method for PowerDemand_Typ Columns	15-37
15.5.2.5	ODCIStatsCollect() Method for power_idxtype Domain Indexes	15-38
15.5.2.6	ODCIStatsDelete() Method for power_idxtype Domain Indexes	15-39
15.5.2.7	ODCIStatsSelectivity() Method for Specific Queries	15-39
15.5.2.8	ODCIStatsIndexCost() Method for Specific Queries	15-45
15.5.2.9	ODCIStatsIndexCost() Method for Any Queries	15-46
15.5.2.10	ODCIStatsFunctionCost() Method	15-47
15.5.3	Associating the Extensible Optimizer Methods with Database Objects	15-48
15.5.4	Analyzing the Database Objects	15-49
15.6	Testing the Domain Index	15-49
15.6.1	Creating and Populating the Power Demand Table	15-50
15.6.2	Querying Without the Index	15-51
15.6.3	Creating the Index	15-53
15.6.4	Querying with the Index	15-53

## 16 PSBTREE: Extensible Indexing Example

---

16.1	About the PSBTREE Example	16-1
16.2	Design of the Indextype	16-1
16.3	Implementing Operators	16-1
16.3.1	Functional Implementations	16-2
16.3.1.1	Implementing the EQUALS Operator	16-2
16.3.1.2	Implementing the LESS THAN Operator	16-2
16.3.1.3	Implementing the GREATER THAN Operator	16-2
16.3.2	Operators	16-2
16.4	Implementing the ODCIIndex Interfaces	16-3
16.4.1	Defining an Implementation Type for PSBTREE	16-3
16.4.2	Creating the Implementation Type Body	16-4
16.4.3	Defining PL/SQL Routines in the Implementation Body	16-4
16.4.3.1	Implementing ODCIGetInterfaces() for PSBTREE in PL/SQL	16-4

16.4.3.2	Implementing ODCIIndexCreate() for PBSTREE in PL/SQL	16-4
16.4.3.3	Implementing ODCIIndexDrop() for PBSTREE in PL/SQL	16-6
16.4.3.4	Implementing ODCIIndexAlter() for PSBTREE in PL/SQL	16-6
16.4.3.5	Implementing ODCIIndexUpdPartMetadata() for PSBTREE in PL/SQL	16-7
16.4.3.6	Implementing ODCIIndexExchangePartition() for PSBTREE in PL/SQL	16-7
16.4.4	Registering the C Implementation of the ODCIIndexXXX() Methods	16-8
16.4.4.1	Registering the Implementation of ODCIIndexInsert()	16-8
16.4.4.2	Registering the Implementation of ODCIIndexDelete()	16-9
16.4.4.3	Registering the Implementation of ODCIIndexUpdate()	16-9
16.4.4.4	Registering the Implementation of ODCIIndexStart()	16-10
16.4.4.5	Registering the Implementation of ODCIIndexFetch()	16-10
16.4.4.6	Registering the Implementation of ODCIIndexClose()	16-11
16.4.5	Defining Additional Structures in C Implementation	16-11
16.4.6	Defining C Methods in the Implementation Body	16-12
16.4.6.1	Implementing a Common Error Processing Routine in C	16-12
16.4.6.2	Implementing ODCIIndexInsert() for PSBTREE in C	16-13
16.4.6.3	Implementing ODCIIndexDelete() for PSBTREE in C	16-15
16.4.6.4	Implementing ODCIIndexUpdate() for PSBTREE in C	16-17
16.4.6.5	Implementing ODCIIndexStart() for PSBTREE in C	16-19
16.4.6.6	Implementing ODCIIndexFetch() for PSBTREE in C	16-23
16.4.6.7	Implementing ODCIIndexClose() for PSBTREE in C	16-25
16.4.7	Implementing the Indextype for PSBTREE	16-26
16.5	Using PSBTREE	16-26
16.5.1	Creating and Populating a Partitioned Table for PSBTREE	16-27
16.5.2	Creating a PSBTREE Index on a Column	16-27
16.5.3	Using PSBTREE Operators in a Query	16-27

## 17 Pipelined Table Functions: Interface Approach Example

---

17.1	Pipelined Table Functions Example: C Implementation	17-1
17.1.1	Making SQL Declarations for C Implementation	17-1
17.1.2	Implementation ODCITable Methods in C	17-2
17.2	Pipelined Table Functions Example: Java Implementation	17-9
17.2.1	Making SQL Declarations for Java Implementation	17-9
17.2.2	Implementing the ODCITable Methods in Java	17-10

## Part IV Reference

---



## 18 Cartridge Services Using C, C++ and Java

---

18.1	OCI Access Functions for External Procedures	18-1
18.1.1	OCIExtProcAllocCallMemory	18-1
18.1.2	OCIExtProcRaiseExcp	18-1
18.1.3	OCIExtProcRaiseExcpWithMsg	18-2
18.1.4	OCIExtProcGetEnv	18-2
18.2	Installing Java Cartridge Services Files	18-2
18.3	Cartridge Services-Maintaining Context	18-3
18.3.1	ContextManager	18-3
18.3.2	CountException()	18-3
18.3.3	CountException(String)	18-4
18.3.4	InvalidKeyException()	18-4
18.3.5	InvalidKeyException(String)	18-4

## 19 Extensibility Constants, Types, and Mappings

---

19.1	System Defined Constants	19-1
19.1.1	ODCIArgDesc.ArgType System Defined Constants	19-1
19.1.2	ODCIEnv.CallProperty System Defined Constants	19-2
19.1.3	ODCIIIndexAlter System Defined Constants	19-2
19.1.4	ODCIIIndexInfo.Flags System Defined Constants	19-3
19.1.5	ODCIIPartInfo.PartOp System Defined Constants	19-4
19.1.6	ODCIIPredInfo.Flags System Defined Constants	19-4
19.1.7	ODCIFuncInfo.Flags System Defined Constants	19-4
19.1.8	ODCIQueryInfo.Flags System Defined Constants	19-5
19.1.9	ODCIStatsOptions.Flags System Defined Constants	19-5
19.1.10	ODCIStatsOptions.Options System Defined Constants	19-5
19.1.11	Return Status System Defined Constants	19-6
19.1.12	ScnFlg System Defined Constants	19-6
19.2	System-Defined Types	19-6
19.2.1	ODCIArgDesc	19-6
19.2.2	ODCIArgDescList	19-7
19.2.3	ODCIRidList	19-7
19.2.4	ODCICollInfo	19-7
19.2.5	ODCICollInfoList	19-8
19.2.6	ODCICost	19-8
19.2.7	ODCIEnv	19-9
19.2.8	ODCIFuncInfo	19-9
19.2.9	ODCIIIndexInfo	19-10
19.2.10	ODCIIIndexCtx	19-10
19.2.11	ODCIOObject	19-11

19.2.12	ODCObjectList	19-11
19.2.13	ODCIPartInfo	19-11
19.2.14	ODCIPartInfoList	19-12
19.2.15	ODCIPredInfo	19-12
19.2.16	ODCIQueryInfo	19-12
19.2.17	ODCIStatsOptions	19-13
19.2.18	ODCITabFuncStats	19-13
19.2.19	ODCITabStats	19-13
19.2.20	ODCIBFileList	19-14
19.2.21	ODCITabFuncInfo	19-14
19.2.22	ODCIDateList	19-14
19.2.23	ODCINumberList	19-14
19.2.24	ODCIRawList	19-14
19.2.25	ODCIVarchar2List	19-14
19.2.26	ODCIFuncCallInfo	19-15
19.3	Mappings of Constants and Types	19-15
19.3.1	Mappings in PL/SQL	19-15
19.3.2	Mappings in C	19-15

## 20 Extensible Indexing Interface

---

20.1	Extensible Indexing - System-Defined Interface Routines	20-1
20.1.1	ODCIGetInterfaces()	20-2
20.1.2	ODCIIndexAlter()	20-2
20.1.3	ODCIIndexClose()	20-5
20.1.4	ODCIIndexCreate()	20-6
20.1.5	ODCIIndexDelete()	20-8
20.1.6	ODCIIndexDrop()	20-9
20.1.7	ODCIIndexExchangePartition()	20-10
20.1.8	ODCIIndexFetch()	20-11
20.1.9	ODCIIndexGetMetadata()	20-12
20.1.10	ODCIIndexInsert()	20-14
20.1.11	ODCIIndexStart()	20-15
20.1.12	ODCIIndexUpdate()	20-18
20.1.13	ODCIIndexUpdPartMetadata()	20-19
20.1.14	ODCIIndexUtilCleanup()	20-19
20.1.15	ODCIIndexUtilGetTableNames()	20-20

## 21 Extensible Optimizer Interface

---

21.1	Extensible Optimizer Interface	21-1
------	--------------------------------	------

21.1.1	Using Statistics Functions in an Extensible Optimizer Interface	21-1
21.1.2	EXPLAIN PLAN	21-2
21.1.3	INDEX Hint	21-3
21.1.4	ORDERED_PREDICATES Hint	21-3
21.2	User-Defined ODCIStats Functions	21-3
21.2.1	ODCIGetInterfaces()	21-4
21.2.2	ODCIStatsCollect()	21-4
21.2.3	ODCIStatsDelete()	21-6
21.2.4	ODCIStatsFunctionCost()	21-8
21.2.5	ODCIStatsExchangePartition()	21-9
21.2.6	ODCIStatsIndexCost()	21-9
21.2.7	ODCIStatsSelectivity()	21-11
21.2.8	ODCIStatsTableFunction()	21-13
21.2.9	ODCIStatsUpdPartStatistics()	21-14

## 22 User-Defined Aggregate Functions Interface

---

22.1	User-Defined Aggregate Functions	22-1
22.1.1	ODCIAggregateDelete()	22-1
22.1.2	ODCIAggregateInitialize()	22-2
22.1.3	ODCIAggregateIterate()	22-2
22.1.4	ODCIAggregateMerge()	22-3
22.1.5	ODCIAggregateTerminate()	22-3
22.1.6	ODCIAggregateWrapContext()	22-4

## 23 Pipelined and Parallel Table Functions

---

23.1	Routines for Pipelined and Parallel Table Functions in C	23-1
23.1.1	ODCITableClose()	23-1
23.1.2	ODCITableDescribe()	23-2
23.1.3	ODCITableFetch()	23-3
23.1.4	ODCITablePrepare()	23-4
23.1.5	ODCITableStart()	23-4

## A User-Managed Local Domain Indexes

---

A.1	Comparing User-Managed and System-Managed Domain Indexes	A-1
A.2	Truncating Domain Indexes	A-2
A.3	Creating Indextypes	A-2
A.4	Using Domain Indexes for the Indextype	A-2
A.5	Partitioning Domain Indexes	A-2
A.6	APIs for User-Managed Domain Indexes	A-2

A.6.1	ODCIIndexTruncate()	A-2
A.6.2	ODCIIndexMergePartition()	A-4
A.6.3	ODCIIndexSplitPartition()	A-4

## Index

---

## List of Figures

---

1-1	Oracle Services	1-4
1-2	External Programs Executing in a Separate Address Space	1-7
2-1	Cartridge Development Process	2-3
5-1	Calling an External Procedure	5-4
7-1	B-tree Index Structure	7-3
7-2	Hash Index Structure	7-3
7-3	2-d Index Structure	7-4
7-4	Point Quadtree Index Structure	7-5
8-1	Three-Partition Table with a Local Domain Index, and Associated Structures	8-24
8-2	A Three-Partition Table after ALTER TABLE SPLIT PARTITION	8-25
10-1	Storing Index-Specific Statistics with Index Tables	10-12
10-2	Storing Index-Specific Statistics in a Separate Table	10-12
10-3	Storing Index-Partition Statistics in a Common Table	10-13
12-1	Sequence of Calls for Parallel Evaluation of User-Defined Aggregates	12-5
13-1	Typical Data Processing with Non-Parallel, Non-Pipelined Table Functions	13-2
13-2	Data Processing Using Pipelining and Parallel Execution	13-2
13-3	Flowchart of Table Function Row Source Execution	13-10
15-1	Region Served by the Power Utility	15-1
15-2	Regional Grid Cells in Numbered Sequence	15-2
15-3	Grayscale Representation of Satellite Image	15-3
15-4	Grayscale Representation of Weather Conditions at Second Recording	15-4
15-5	Grayscale Representation of Conditions as Projected	15-5
15-6	Distribution of Power Stations Across the Region	15-6
15-7	Areas Served by Three Power Stations	15-7
15-8	Application Object Model of the Power Demand Cartridge	15-8
15-9	Implementation Model of the Power Demand Cartridge	15-9

## List of Tables

---

1-1	Data Cartridge Domains; Content and Scope	1-3
2-1	Data Cartridge Naming Conventions	2-7
5-1	Parameter Datatype Mappings	5-7
5-2	External Data Type Mappings	5-7
6-1	Summary of OCI Functions for Manipulating LOBs	6-5
6-2	OCI and PL/SQL (DBMS_LOB) Interfaces Compared	6-6
6-3	Summary of DBMS_LOB Package Routines	6-9
8-1	Views *_INDEXTYPE_COMMENTS	8-8
8-2	Views *_SECONDARY_OBJECTS	8-13
8-3	Default and Explicit Drop Options for Operators and Index Types	8-14
8-4	Summary of Index States	8-17
8-5	Summary of Table Operations	8-18
8-6	Summary of ALTER TABLE Operations with Partition Maintenance	8-18
8-7	ODCIXXX() Methods for Non-Partitioned Domain Indexes	8-26
8-8	ODCIXXX() Methods for Local System-Managed Domain Indexes	8-27
10-1	Statistics Methods and Default Statistics for Various Schema Objects	10-5
10-2	Effects of DDL on Partition and Global Statistics	10-18
10-3	Dependency Model for DDLs	10-19
11-1	Special Characters	11-6
13-1	Generic SQL Types	13-24
15-1	Sample Power Demand Readings for an Hour	15-2
15-2	Sample Power Demand Readings for an Hour	15-10
15-3	Operators and Implementing Functions	15-15
15-4	Indextype Methods	15-17
15-5	Extensible Optimizer Methods	15-33
19-1	ODCIArgDesc.ArgType Values	19-1
19-2	ODCIEnv.CallProperty Values	19-2
19-3	ODCIIndexAlter Options	19-2
19-4	ODCIIndexInfo.Flags Bits	19-3
19-5	Description of the ODCIIPartInfo.PartOp System Defined Constant	19-4
19-6	ODCIIPredInfo.Flags Bits	19-4
19-7	ODCIFuncInfo.Flags Bits	19-4
19-8	ODCIQueryInfo.Flags Bits	19-5
19-9	ODCIStatsOptions.Flags Bits	19-5
19-10	ODCIStatsOptions.Options Bits	19-5

19-11	Return Status Values	19-6
19-12	ScnFlg Values; Function with Index Context	19-6
19-13	ODCIArgDesc Function and Operator Argument Description - Attributes	19-7
19-14	ODCICollInfo Column Related Information - Attributes	19-8
19-15	ODCICost Cost Information - Attributes	19-8
19-16	ODCIEnv Environment Variable Descriptor Information - Attributes	19-9
19-17	ODCIFuncInfo Function Information - Attributes	19-9
19-18	ODCIIndexInfo Index Related Information - Attributes	19-10
19-19	ODCIIndexCtx Index Context Related Information - Attributes	19-11
19-20	ODCIObject Index Context Related Information - Attributes	19-11
19-21	ODCIPartInfo Index-Related Information - Attributes	19-11
19-22	ODCIPredInfo Operator Related Information - Attributes	19-12
19-23	ODCIQueryInfo Index Context Related Information - Attributes	19-13
19-24	ODCIStatsOptions Cost Information - Attributes	19-13
19-25	ODCITabFuncStats Parameter	19-13
19-26	ODCITabStats - Attributes	19-13
19-27	ODCITabFuncInfo Parameters	19-14
19-28	ODCIFuncCallInfo - Attributes	19-15
20-1	Summary of System-Defined Extensible Indexing Interface Routines	20-1
21-1	Summary of User-Defined ODCIStats Functions	21-3
22-1	Summary of User-Defined Aggregate Functions	22-1
23-1	Summary of Pipelined and Parallel Table Functions for C	23-1

# Preface

The *Oracle Database Data Cartridge Developer's Guide* describes how to build and use data cartridges to create custom extensions to the Oracle server's indexing and optimizing capabilities.

## Audience

*Oracle Database Data Cartridge Developer's Guide* is intended for developers who want to learn how to build and use data cartridges to customize the indexing and optimizing functionality of the Oracle server to suit specialty data such as that associated with chemical, genomic, or multimedia applications.

To use this document, you must be familiar with using Oracle and should have a background in an Oracle-supported programming language such as PL/SQL, C, C++, or Java.

## Documentation Accessibility

For information about Oracle's commitment to accessibility, visit the Oracle Accessibility Program website at <http://www.oracle.com/pls/topic/lookup?ctx=acc&id=docacc>.

### Access to Oracle Support

Oracle customers that have purchased support have access to electronic support through My Oracle Support. For information, visit <http://www.oracle.com/pls/topic/lookup?ctx=acc&id=info> or visit <http://www.oracle.com/pls/topic/lookup?ctx=acc&id=trs> if you are hearing impaired.

## Conventions

The following text conventions are used in this document:

Convention	Meaning
<b>boldface</b>	Boldface type indicates graphical user interface elements associated with an action, or terms defined in text or the glossary.
<i>italic</i>	Italic type indicates book titles, emphasis, or placeholder variables for which you supply particular values.
monospace	Monospace type indicates commands within a paragraph, URLs, code in examples, text that appears on the screen, or text that you enter.



# Changes in This Release for Oracle Database Data Cartridge Developer's Guide

This preface contains:

- [Changes in Oracle Database 18c, Version 18.1](#)

## Changes in Oracle Database 18c, Version 18.1

This section lists changes in *Oracle Database Data Cartridge Developer's Guide* for Oracle Database release 18c, version 18.1.

See *Oracle Database New Features Guide* for a complete list of new features in this release.

Support for local domain index on reference partitioned tables is enhanced. A local domain index can now be created on a reference partitioned table whose root table is a composite partitioned table.



### See Also:

[Partitioned Domain Indexes](#)

# Part I

## Introduction

Oracle Database provides Data Cartridges to support customized application development in the object mode.

# 1

## Introduction to Data Cartridges

Oracle Database provides Data Cartridges to support customized application development in the object mode.

In addition to efficient and secure management of data ordered under the relational model, Oracle provides support for data organized under the object model. Object types and other features such as large objects (LOBs), external procedures, extensible indexing, and query optimization can be used to build powerful, reusable, server-based components called **data cartridges**.

### 1.1 Overview of Data Cartridges

Data cartridges extend the capabilities of the Oracle server by taking advantage of **Oracle Extensibility Architecture** framework. This framework lets you capture business logic and processes associated with specialized or domain-specific data in user-defined data types. Data cartridges that provide new behavior without needing additional attributes have the option of using packages rather than user-defined types. Either way, you determine how the server interprets, stores, retrieves, and indexes the application data. Data cartridges package this functionality, creating software components that plug into a server and extend its capabilities into a new domain, making the database itself **extensible**.

You can customize the indexing and query optimization mechanisms of an extensible database management system and provide specialized services or more efficient processing for user-defined business objects and rich types. When you register your implementations with the server through **extensibility interfaces**, you direct the server to implement your customized processing instructions instead of its own default processes.

The extensibility interfaces consist of functions that the server calls to execute the custom indexing or optimizing behavior implemented for a data cartridge. The interfaces are defined by Oracle; as a cartridge developer, you must implement the functions or interfaces that have the specialized behavior you require in your application. In general, you implement the functions as static methods of an object type. An object type that implements the extensible indexing interface is called an **indextype**; an object type that implements the extensible optimizing interface is called a **statistics type**.

Data cartridges have the following key characteristics:

- *Data cartridges are server-based.* Their constituents reside on the server or are accessed from the server. The server runs all data cartridge processes, or dispatches these processes as external procedures.
- *Data cartridges extend the server.* They define new types and behavior, enabling the server to perform processes that are otherwise unavailable to it, in component form. Data cartridges can use these new types and behaviors in their applications.
- *Data cartridges are integrated with the server.* The Oracle Extensibility Framework defines a set of interfaces that integrate data cartridges with the components of

the server engine, allowing for domain-specific indexing, domain-specific optimized access to the CPU resources, and domain-specific optimization of I/O access to cartridge data.

- *Data cartridges are packaged.* A data cartridge is installed as a unit. After it is installed, the data cartridge handles all access issues for each user, including verification of schemas and privileges.

## 1.2 Uses of Data Cartridges

Most industries have evolved sophisticated models to handle complex **data objects** that form the essence of their business. These data objects are both the structures that relate different units of information and the operations that are performed on them.

The simple names given to data objects often conceal considerable complexity. For example, the banking industry has many different types of bank accounts. Each bank account has customer demographic information, balance information, transaction information, and rules that embody its behavior (deposit, withdrawal, interest accrual, and so forth). When using data cartridges and their object-relational extension, application programmers and independent software vendors can encapsulate business logic in software components that integrate with the Oracle server and enhance it to support data types, processes, and logic to model business objects.

While business models have developed increasingly complex data objects, information technology has made it necessary to work with new and complex kinds of data, such as satellite images, X-rays, animal sounds, seismic vibrations, and chemical models. Complex and multimedia data types are now frequently stored and retrieved, queried and analyzed.

Web-based applications routinely include many different kinds of complex data. Including application-specific data types and the associated business logic requires a new class of networked, content-rich, multitiered, distributed applications. Data cartridges help you meet this need by combining scalar and unstructured data types in domain-specific components.

### 1.2.1 Data Cartridge Domains

Data cartridges are typically domain-specific, characterized by content and scope of their target domain.

In terms of **content**, a data cartridge can accommodate scalar, complex, and multimedia data. Scalar data can be modeled using native SQL types such as `INTEGER`, `NUMBER`, or `CHAR`. Complex data include matrices, temperature and magnetic grids, and compound documents. Unstructured multimedia data includes such information as video, voice, and image data.

In terms of **scope**, a data cartridge can have either broad horizontal (cross-industry) coverage, or it can be specialized for a specific type of business. For example, a data cartridge for general storage and retrieval of text-based data is cross-industry in scope; a data cartridge for the storage and retrieval of legal documents for litigation support is industry-specific. [Table 1-1](#) shows a way of classifying data cartridge domains according to their content and scope, with some examples.

**Table 1-1 Data Cartridge Domains; Content and Scope**

Content	Cross-Industry Uses	Industry-Specific Extensions
Scalar Data	Statistical conversion	Financial and Petroleum
Multimedia and Complex Unstructured Data	Text	Image
Audio/Video	Spatial	Legal
Medical	Broadcasting	Utilities

You can also use scalar data types to construct more complex user-defined types. The object-relational database management system provides foundational data cartridges that package multimedia and complex data. These data cartridges can be used in developing applications across many different industries:

- Oracle Text uses the tokenized serial byte stream database model are used to implement display compress, reformat, and indexing behavior.
- Oracle Multimedia uses the database model for structured large objects to support storage and management of image, audio and video.
- Oracle Spatial is for use with geometric objects (points, lines, polygons); it implements project, rotate, transform and map behavior.

Another way of viewing the relationship of cartridges to domains is to consider basic multimedia data types as an extensible foundation that can be customized for specific industries. For example, medical applications can customize the Oracle Text for records, Oracle Multimedia for MRI results and heartbeat monitoring, and Oracle Spatial for demographic analysis.

A cartridge that provides basic services can be deployed across many industries. A cartridge can also leverage domain expertise across an industry. These cartridges can be further extended for more specialized vertical applications.

## 1.3 Extending the Server: Services and Interfaces

The Oracle server provides services for basic data storage, query processing, optimization, and indexing. Applications use these services to access database capabilities. However, data cartridges have specialized needs because they incorporate domain-specific data. To accommodate these specialized applications, these basic services have been made extensible; where standard Oracle services are not adequate for meeting a data cartridge's requirements, you can provide additional services that satisfy the requirements of the specific data cartridge. Every data cartridge can provide its own implementations of these services.

For example, if you are developing a spatial data cartridge for geographic information systems (GIS) applications, you must to implement routines that create a spatial index, insert an entry into the index, update the index, delete from the index, and perform other required operations. Thus, you extend the indexing service of the server.

 **See Also:**  
[Power Demand Cartridge Example](#)

## 1.3.1 Extensibility Services

Consider extensible services and major Oracle capabilities as they relate to data cartridge development. [Figure 1-1](#) shows the standard services implemented by the Oracle server.

**Figure 1-1 Oracle Services**

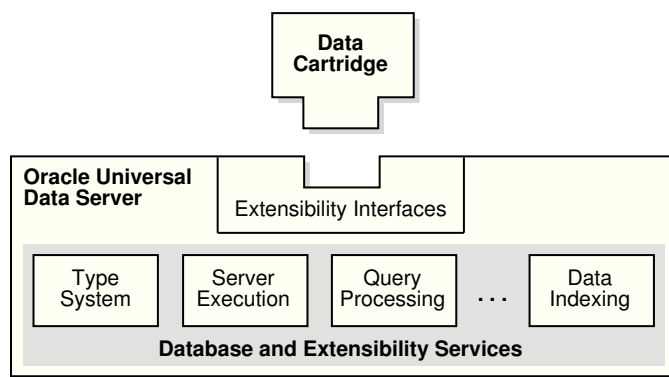

### 1.3.1.1 Extensible Type System

The Oracle universal data server provides both native and extensible type system services. Historically, most applications have focused on accessing and modifying corporate data that is stored in tables composed of native SQL data types, such as `INTEGER`, `NUMBER`, `DATE`, and `CHAR`. Oracle adds support for new types, including:

- User-defined object types
- Collections, such as `VARRAY` (varying length array) and nested tables
- Relationships (`REFS`)
- Large object types (`LOBS`), such as binary large objects (`BLOBS`), character large objects (`CLOBs`), and external binary files (`BFILES`)

#### 1.3.1.1.1 User-Defined Types

A **user-defined type** extends the modeling capabilities of the native data types and from them both because it is defined by a user, and because it specifies both the underlying persistent data (attributes) and the related behaviors (methods).

With user-defined types, you can make better models of complex entities in the real world by binding data **attributes** to semantic behaviors. A user-defined type can have one or more attributes, each with a name and a type. The type of an attribute can be a native SQL type, a `LOB`, a collection, another object type, or a `REF` type.

A **method** is a procedure or a function that is part of a user-defined type. Methods can access and manipulate attributes of their type while running within the execution environment of the Oracle server, or when they are dispatched outside the server as part of the extensible server execution environment.

 **See Also:**

- [Defining Object Types](#) for type definition syntax.
- *Oracle Database Object-Relational Developer's Guide* for more information on user-defined types.

### 1.3.1.1.2 Collection Types

**Collections** are SQL data types that contain multiple elements. Elements, or values, of a collection are all from the same type hierarchy. In Oracle, collections of complex types can be `VARRAYS` or nested tables.

A `VARRAY` type contains a variable number of ordered elements and can be used for a column of a table or an attribute of an object type. The element type of a `VARRAY` can be either a native data type, such as `NUMBER`, or a user-defined type.

To provide the semantics of an unordered collection, you could create a nested table using Oracle SQL As with a `VARRAY`, a nested table can define a column of a table or an attribute of a user-defined type.

### 1.3.1.1.3 Reference Types

If you create an object table in Oracle, you can obtain a **reference**, `REF`, that behaves like a database pointer to an associated row object. References are important for navigating among object instances. Because `REFs` rely on the underlying object identity, you can only use a `REF` with an object stored as a row in an object table, or with objects composed from an object view.

 **See Also:**

- *Oracle Database SQL Language Reference* for details of the `REF` operator.
- *Oracle Database Object-Relational Developer's Guide* for more information about objects.

### 1.3.1.1.4 Large Objects

**Large object** types, or `LOBs`, handle the storage demands of images, video clips, documents, and other forms of unstructured data. `LOBs` storage optimizes space requirements and efficient access.

`LOBs` are composed of locators and the related binary or character data. The locators are stored inline with other table columns. Internal `LOBs` (`BLOBs`, `CLOBs`, and `NCLOBs`) can store data in a separate database storage area. External `LOBs` (`BFILES`) store the data outside the database tablespaces, in operating system files. A table can contain

multiple `LOB` columns, in contrast to the limit of a single `LONG RAW` column for each table. Each `LOB` column can be stored in a separate tablespace, and even on different secondary storage devices.

You can create, modify, and delete tables and object types that contain `LOBs` using the Oracle SQL data definition language (DDL) extensions. Using the Oracle SQL data manipulation language (DML) statements, you can insert and delete complete `LOBs`. There is also an extensive set of statements for piece-wise reading, writing, and manipulating of `LOBs` within Java, PL/SQL, and the Oracle Call Interface.

For internal `LOB` types, both the locators and related data participate fully in the transactional model of the Oracle server. The data for `BFILEs` does not participate in transactions; however, `BFILE` locators are fully supported by Oracle server transactions.

Unlike scalar quantities, a `LOB` value cannot be indexed by built-in indexing schemes. However, you can use the various `LOB` APIs to build modules, including methods of user-defined types, to access and manipulate `LOB` content. You can define the semantics of data residing in `LOBs` and manipulate this data using the extensible indexing framework.



#### See Also:

- [Working with Multimedia Data Types](#) for information on how to use `LOBs` to store and manipulate binary and character data that represents your domain.
- *Oracle Database SecureFiles and Large Objects Developer's Guide* for detailed discussions of large objects.

### 1.3.1.2 Extensible Server Execution Environment

The Oracle type system decouples the implementation of a member method for a user-defined type from the specification of that method. Oracle data cartridge components can be implemented using a large number of popular programming languages, such as PL/SQL, C, C++, or Java, extending the database server run-time environment by user-defined methods, functions, and procedures.

Java offers data cartridge developers a powerful implementation choice for data cartridge behavior. PL/SQL is a powerful procedural language that supports all the object extensions for SQL. With PL/SQL, program logic can execute on the server and perform traditional procedural language operations such as loops, if-then-else clauses, and array access.

While PL/SQL and Java are powerful, certain computation-intensive operations such as a Fast Fourier Transform or an image format conversion are handled more efficiently by C programs. You can call C language programs from the server, running them in a separate address space, thus insulating the server and protecting the database from corruption by external procedure failures.

With certain reasonable restrictions, external procedures can **callback** the Oracle Server using OCI. Callbacks are particularly useful for processing `LOBs`. External procedure can use callbacks to perform piece-wise reads or writes of `LOBs` stored in



the database, or to manipulate domain indexes stored as index-organized tables in the database.

**Figure 1-2 External Programs Executing in a Separate Address Space**

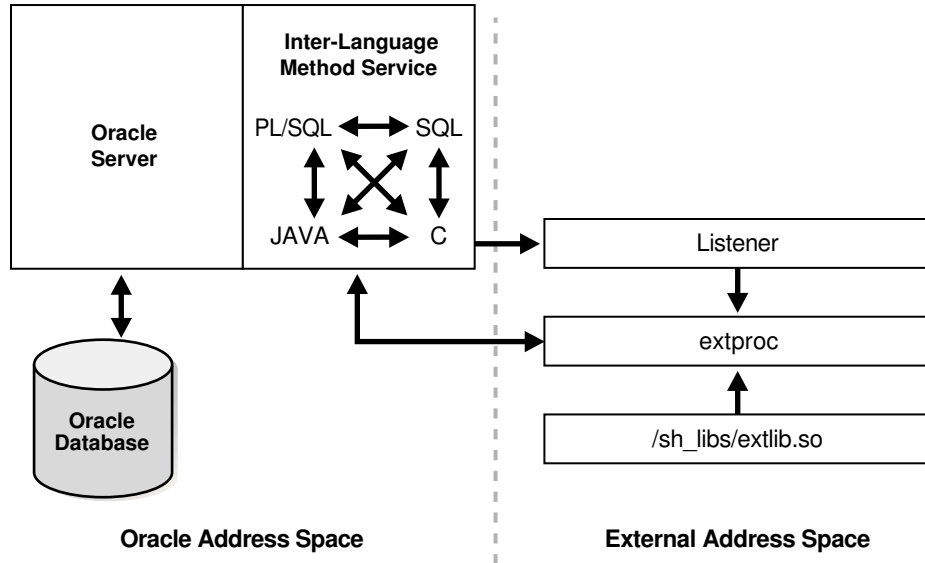

### 1.3.1.3 Extensible Indexing

Basic database management systems support a few types of access methods, such as B+ trees and hash indexes, on a limited set of data types, such as numbers and strings. For simple data types like integers and small strings, all aspects of indexing can easily be handled by the database system. As data becomes more complex with addition of text, spatial, image, video, and audio information, it requires complex data types and specialized indexing techniques.

Complex data types have application-specific formats, indexing requirements, and selection predicates. For example, there are many different means of document encoding (ODA, XML, plain text) and information retrieval techniques (keyword, full-text boolean, similarity, and probabilistic). Similarly, R-trees are an efficient method of indexing spatial data. To enable you to define the index types necessary for your business requirements, Oracle provides an extensible indexing framework.

Such user-defined indexes are called **domain indexes** because they index data in an application-specific domain. The cartridge is responsible for defining the index structure, maintaining the index content during load and update operations, and searching the index during query processing. The physical index can be stored either in the Oracle database as tables, or externally as a file.

A domain index is a schema object. It is created, managed, and accessed by routines implemented as methods of a user-defined type called an **indextype**. The routines that an indextype must implement, and the operations the routines must perform, are described in [Building Domain Indexes](#). Implementation of the routines is specific to an application, and must therefore be completed by the cartridge developer.

With extensible indexing, the application must have the following processes:

- Define the structure of the domain index.
- Store the index data, either inside or outside the Oracle database.
- Manage, retrieve, and use the index data to evaluate user queries.

When the database system handles the physical storage of domain indexes, data cartridges must have the following processes:

- Define the format and content of an index. Cartridges define an index structure that can accommodate a complex data object.
- Build, delete, and update a domain index. Cartridges build and maintain the index structures. Because indexes are modeled as collections of tuples, they directly support in-place updates.
- Access and interpret the content of an index. Cartridges become an integral component of query processing by handling content-related clauses for database queries.

Typical relational and object-relational database management systems do not support extensible indexing. Consequently, many applications maintain file-based indexes for complex data in relational database tables. A considerable amount of code and effort is required to complete the following tasks:

- Maintain consistency between external indexes and the related relational data.
- Support compound queries involving tabular values and external indexes.
- Manage the system, performing backup, recovery, storage allocation, and so on, with multiple forms of persistent storage, such as files and databases.

By supporting extensible indexes, the Oracle server significantly reduces the level of effort needed to develop solutions involving high-performance access to complex data types.

### 1.3.1.4 Extensible Optimizer

The **extensible optimizer** lets user-defined functions and indexes collect statistical information, such as selectivity and cost functions, and generates an execution plan for a SQL statement. This information is used by the optimizer in choosing a query plan, thus extending the optimizer to use the user-supplied information. The rule-based optimizer remains unchanged.

An **execution plan** generated by the optimizer includes an access method for each table in the `FROM` clause, and an ordering, called the **join order**, of the tables in the `FROM` clause. System-defined access methods include indexes, hash clusters, and table scans. For each table in the join order, the optimizer chooses a plan by generating a set of join orders or permutations, computing the cost of each, and selecting the one with the lowest cost. The cost of the join order is the sum of the access method and join method costs.

The **cost model** is a group of algorithms used for calculating the cost of a given operation. It can include varying levels of detail about the physical environment in which the query runs. The current cost model includes the number of disk accesses and estimates of network costs, with minor adjustments.

The optimizer also uses statistics about the objects referenced in the query to calculate cost and **selectivity**, or the fraction of rows in a table that a query selects (between 0 and 100, a percentage). The `DBMS_STATS` package contains methods for generating these statistics.

Extensibility allows users to define new operators, index types, and domain indexes, and enables the control of the three main components used by the optimizer to select an execution plan: statistics, selectivity, and cost.

 **See Also:**

*Oracle Database PL/SQL Packages and Types Reference* for information about `DBMS_STATS`.

## 1.3.2 Extensibility Interfaces

There are three classes of extensibility interfaces: DBMS interfaces, cartridge basic service interfaces, and data cartridge interfaces.

### DBMS Interfaces

The DBMS interfaces offer the simplest kind of extensibility services. They can be used through extensions to SQL or to the Oracle Call Interface (OCI). For example, the extensible type manager uses the `CREATE TYPE` syntax in SQL. Similarly, extensible indexing uses DDL and DML support for specifying and manipulating indexes.

### Cartridge Basic Service Interfaces

Cartridge basic interfaces provide generic services like memory management, context management, internationalization, and cartridge-specific management. They implement behavior for new data types for the server's execution environment, and provide routines that help developers implement portable and robust server-side methods.

### Data Cartridge Interfaces

When processing user-defined indextypes, Oracle calls data cartridge functions to perform index search or fetch operations. For user-defined query optimization, the query optimizer calls functions implemented by the data cartridge to compute the cost of user-defined operators or functions.

# 2

## Roadmap to Building a Data Cartridge

Consider the recommended process for developing data cartridges, including relationships and dependencies among the steps of the process.

### 2.1 Data Cartridge Development Process

To understand the Data Cartridge development process, consider the project as a whole.

#### Understanding the Purpose

The first step in developing a data cartridge is to establish the domain-specific value you intend to provide by clearly defining the new capabilities of the cartridge. Specify the objects the cartridge exposes to users.

#### Understand the Users

If the intended users of the cartridge are software developers, the extensibility of the cartridge is of crucial importance. If they are end-users, the cartridge must be highly attuned to its intended domain. The design of the cartridge should reflect a business model that has a clear understanding of all users. Regardless of the size of the cartridge, the development team must have a thorough understand the object-relational database management system and apply it to the problems of the cartridge's domain.

#### Plan the Project

Use a well-defined software development process, clearly identify expectations and deliverables, and set reasonable milestones for Data Cartridge development. Scheduling appropriate time for the project and having a realistic picture of available resources skills makes the project more likely to succeed.

#### Implement the Project

A detailed outline of this phase of Data Cartridge development is described in [Implement the Project](#)

#### Test and Installation

The final steps are to test the application and create the necessary installation scripts.

#### 2.1.1 Implement the Project

- When choosing and designing objects, ensure that their names and semantics are familiar and clearly understood by developers and end-users.
- When defining a collection of objects, consider the interface between the SQL side of object methods and the programming language used in your application development. Keep this interface as simple as possible by limiting the number of

methods that call library routines, avoiding numerous calls into low-level library entry points, and writing large blocks of code that worked with pre-fetched data.

- After the interface is defined, proceed along parallel paths, as illustrated in [Figure 2-1](#). You can proceed on the paths in any order that suits the available resources.

The left-most of these parallel paths packages existing 3GL code that performs relevant operations in a run-time library such as a DLL, possibly with new entry points on top of old code. The library routines are called by the SQL component of the object's method code. Where possible, this code should be tested in a standalone fashion using a 3GL test program.

The middle path defines and writes the object's type specification and the PL/SQL components of the object's method code. Some methods can be written entirely in PL/SQL, while others call into the external library. If your application requires an external library, provide the library definition and the detailed bindings to library entry routines.

The direction you take at the choice point depends on the complexity of the access methods you must deploy to manipulate your data. If the query methods you need are relatively simple, you can build regular indexes. If your data is complex, you must define complex index types to make use of Oracle's extensible indexing technology. If your project uses multi-domain queries, you should make use of Oracle's extensible optimizer technology.

If your situation does not involve executing queries on multiple domains, and I/O is the only significant factor affecting performance, then the standard optimizing techniques are probably sufficient. However, if there are other factors such as CPU cost affecting performance, you may still use the extensible optimizer.

Figure 2-1 Cartridge Development Process

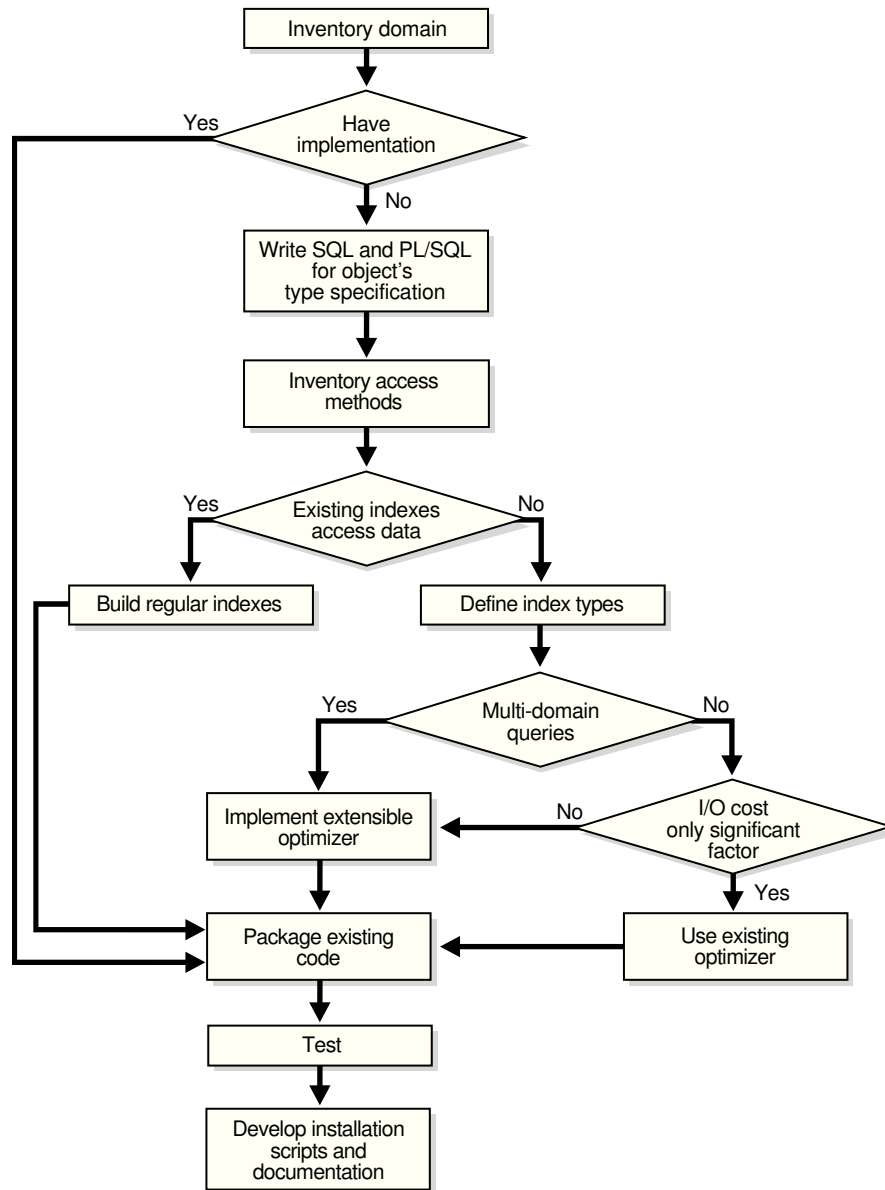

## 2.2 Installing and Using Data Cartridges

**Installation** of a data cartridge is the process of assembling its components so that the server can locate them and understand the user-defined type definitions. To correctly place these components, you must:

1. Define tables and user-defined types in the server. This is usually accomplished by running SQL scripts.
2. Place the dynamic link libraries in the location expected by the linkage specification.
3. Copy online documentation, help files, and error message files to a managed location.

4. Register the user-defined types with the server by running SQL scripts that load each new types defined for the cartridge. This step must be performed from a privileged account.
5. Grant the necessary access privileges to the users of the cartridge.

## 2.3 Requirements and Guidelines for Data Cartridge Components

The following requirements and guidelines apply to some database objects associated with data cartridges.

### 2.3.1 Cartridge Schemas

The database components that form each cartridge must be installed in a schema that has the same name as the cartridge. If a cartridge uses multiple schemes, the first 10 characters of each schema name must be identical to the cartridge name. Note that the length of schema names in Oracle is limited to 30 bytes, or 30 characters in a single-byte language.

The database components of a data cartridge that must be placed in the cartridge schema include names for types, tables, views, directories, libraries and packages. Because the schema name and username are always the same in Oracle, the choice of a schema name determines the username.

### 2.3.2 Cartridge Globals

Some database-level cartridge components are in scope, and are therefore visible to all users instead of being within the scope of a single user or schema. Examples of such globals are roles, synonyms, and sequences. All global names should start with the cartridge name, and be of the form:

*C\$CARTRIDGEGLOBAL*

### 2.3.3 Cartridge Error Message Names or Error Codes

Currently, error code `ORA-20000` is reserved for all errors generated by applications that use Oracle products. The error message text is customizable. You should write the cartridge-specific error messages in the form:

`ORA-20000: C$CARTRIDGE-NNNN:%s`

where

- *C\$CARTRIDGE* is the name of the cartridge where the error originated
- *NNNN* is the number of the error message, unique to that cartridge
- *%s* is the description of the cartridge-specific error

 **Note:**

*Oracle Database Error Messages* for information on writing and managing error messages

## 2.3.4 Cartridge Installation Directory

Oracle recommends that you create a cartridge installation directory, specific to a vendor or client organization. This installation directory should include the operating system-level components of the cartridge, such as shared libraries, configuration files, directories, and similar components. This directory name should be identical to the prefix chosen by the organization, and created under the root directory for the platform.

## 2.3.5 Cartridge Files

Oracle recommends that you place error message files associated with each cartridge into cartridge-specific subdirectories. It is also convenient to keep configuration files in a cartridge-specific subdirectory.

## 2.3.6 Shared Library Names for External Procedures

Shared libraries (.so or .dll files) can be placed either into the cartridge installation directory (all library names must be unique), or into a separate directory. If you are using a separate directory, the file names should start with the cartridge name, excluding the initial c\$. If there are many such libraries, each name should start with the first seven letters of the cartridge name, again excluding the c\$.

## 2.4 Data Cartridge Deployment

At the *deployment* level, you face several common issues. The optimal approach to these problems depends on the needs of your application. The following list includes tasks that should form the basis of your checklist, and some proposed solutions.

- You need a way to install and uninstall your cartridge components. This includes libraries, database objects, flat files, programs, configuration tools, administration tools, and other objects.
- You should allow for installation of multiple versions of a cartridge to provide backward compatibility and availability. Incorporate Oracle's migration facilities into your strategy.
- You must track which data cartridges are installed to support other cartridges that depend on them.
- You must track different versions of installed components.
- You must provide an upgrade path for migrating to newer versions of cartridges. Again, Oracle's migration facilities can be helpful.
- To limit access to cartridge components to specific users and roles, combine Oracle's security mechanisms with procedures that operate under invoker's and definer's rights depending on the need.



- You must keep track of which users have access to a cartridge for administration purposes. Consider making use of a table with appropriate triggers.
- Knowing where cartridges are installed is often a security and administration concern. There is currently no easy way of knowing which cartridges are installed in a particular database or what users have access to the cartridge or any of its components. If this information is important in your situation, keep track of it by any convenient method.

## 2.4.1 Data Cartridge Naming Conventions

Consider how the components of a data cartridge should be named; this discussion is intended for independent software vendors (ISVs) and others who are creating cartridges to be used by others.

Note that most examples that illustrate Data Cartridges do not follow the naming conventions, primarily because they are intended to be as simple and as generic as possible. As your familiarity with the technology increases and you consider building data cartridges to be for use by others, you should understand and follow these naming conventions.

The naming conventions assume a single-byte character set.

### See Also:

- "[Cartridge Internationalization](#)" for information on using other character sets
- "[Globalization Support](#)" for information on support for multiple languages and locales

### 2.4.1.1 Need for Naming Conventions in Data Cartridges

In a production environment, an Oracle database might have multiple data cartridges installed. These data cartridges could be from different development groups or vendors, thus developed in isolation. Each data cartridge consists of various schema objects inside the database, and other components visible at the operating system level, such as external procedures in shared libraries. If multiple data cartridges tried to use the same names for schema objects or operating system-level entities, the result would be incorrect and inconsistent behavior.

Furthermore, because exception conditions during the run-time operation of data cartridges can cause the Oracle server to return errors, it is important to prevent conflicts between error or message codes of different data cartridges. These conflicts can arise if, for example, two cartridges use the same error code for different error conditions. Having unique error and message codes ensures that the origin of the exception condition can be readily identified.

### 2.4.1.2 Unique Name Format

To prevent multiple data cartridge components from having the same name, Oracle recommends the following convention to ensure unique naming of data cartridges. This convention depends on each organization developing data cartridges choosing a

unique name. Oracle recommends that cartridge developers follow a unique name format that starts with a C\$.

Data cartridges and their components should have names of the following format:

```
C$pppptttm.ccccc
```

Table 2-1 describes the parts of this naming convention format.

Oracle recommends that all characters in the name except for the dollar sign, \$, as the second character be alphanumeric: letters, numbers, underscores, and hyphens.

For example, Acme Cartridge Company chooses and registers a prefix of ACME. It provides an audio data cartridge and a video data cartridge, and chooses AUD and VID as the type codes, respectively. It has no other information to include in the cartridge name, and so it chooses an arbitrary number 1 for the miscellaneous information indicator. As a result, the two cartridge names are:

- C\$ACMEAUD1
- C\$ACMEVID1

For each cartridge, a separate schema must be created, and Acme uses the cartridge name as the schema name. Thus, all database components of the audio cartridge must be created under the schema C\$ACMEAUD1, and all database components of the video cartridge must be created under the schema C\$ACMEVID1. Examples of some components might include:

- C\$ACMEVID1.mf\_rewind
- C\$ACMEVID1.vid\_ops\_package
- C\$ACMEVID1.vid\_stream\_lib

Each organization is responsible for specific naming requirements after the C\$pppp portion of the object name. For example, Acme Cartridge Company must ensure that all of its cartridges have unique names and that all components within a cartridge have unique names.

### 2.4.1.3 Data Cartridge Naming Conventions

The following table describes the parts of this naming convention format

**Table 2-1 Data Cartridge Naming Conventions**

Part	Explanation	Example
C\$	Recommended by Oracle for all data cartridges.	
pppp	Prefix selected by the data cartridge creator. (Must be exactly four characters.)	ACME
ttt	Type of cartridge, using an abbreviation meaningful to the creator. Three characters.	AUD (for <i>audio</i> )
m	Miscellaneous information indicator, to allow a designation meaningful to the creator. One character.	1 (perhaps a version number)
. (period)	Period required if specifying an object in full <i>schema.object</i> form.	
cccc	Component name. Variable length.	mf_set_volume

## 2.4.2 Cartridge Registration

A naming scheme requires a registration process to handle the administration of names of components that form a data cartridge.

## 2.4.3 Cartridge Directory Structure and Standards

You need some directory standards that specify where to put your binaries, support files, messages files, administration files, and libraries.

You must also define a database user who installs your cartridges. One possible solution is to use `EXDSYS`, for External Data Cartridge System user.



### Note:

The `EXDSYS` user must have special privileges necessary for running cartridges. This user may be installed as part of cartridge installation, but a better solution is to make the user part of the database installation by including this process in the standard database creation script.

## 2.4.4 Cartridge Upgrades

Administrators need a safe way to upgrade a cartridge and its related metadata to a newer version of the cartridge. You also require a process for upgrading data and removing obsolete data. This may entail installation support and database support for moving to newer database cartridge types

Administrators also require a means to update tables using cartridge types when a cartridge changes.

## 2.4.5 Import and Export of Cartridge Objects

To import and export objects, you must understand how Oracle's import and export facilities handle Oracle objects. In particular, you must know how types are handled and whether the type methods are imported and exported, and also whether user-defined methods are supported.

## 2.4.6 Cartridge Versioning

There are two types of cartridge versioning problems that must be addressed: internal and external.

### External Versioning

External versioning is the easier of the two versioning problems. You must be able to track a cartridge version number and act accordingly upon installation or configuration based on versioning information.

### Internal Versioning

Internal versioning is the harder problem. Ideally, you would like a mechanism to support multiple versions of a cartridge in the database. This would provide backward compatibility and also make for high availability.

## 2.4.7 Cartridge Internationalization

You might want to internationalize your cartridges, so they can support multiple languages and access Globalization Support facilities for messages and parsing.

Oracle recommends that data cartridge component names use the ASCII character set.

If you must name the data cartridge components in a character set other than ASCII, Oracle assigns you a unique four-character prefix. However, this increases the number of bytes required to hold the prefix. The names of all Oracle schema objects must fit into 30 bytes. In ASCII, this equals 30 characters. If you have, for example, a six-byte character set and request a four-character prefix string, Oracle might truncate your request to a smaller number of characters.



#### See Also:

*Oracle Database Globalization Support Guide*

## 2.4.8 Cartridge Administration

When planning and developing a data cartridge, you should consider the issues involved in administering its use.

### Administering Data Cartridge Access

- How do administrators know who has access to a cartridge?

Administrators must administer access rights to internal and external components such as programs and data files to specific users and roles.

- How do administrators restrict access to certain tables, types, views, and other cartridge components to individual users and roles?

For security reasons, administrators must be allowed to restrict access to types on an individual basis.

Some data cartridges, such as Oracle Multimedia, have few security issues. These cartridges might grant privileges to every user in the database. Other cartridges that are more complex might need differing security models. In building complex data cartridges, you need a way to identify the various components of your cartridge and instances of the cartridge, so administrators can grant and revoke security roles on identifiable components.

### Invoker's Rights

Invoker's rights is a special privilege that allows the system to access database objects to which it would not normally have access. The special user `sys` has such rights.

Unless you grant privileges to public, the user you create to install and run your cartridge needs this privilege.

### Data Cartridge Configuration

Data cartridges need a front end to handle deployment issues, such as installation, and configuration tools. While each data cartridge may have differing security needs, a basic front end that allows a user to install, configure, and administer data cartridge components is necessary.

This front end may just be some form of knowledge base or on-line documentation. In any case, it should be online, easy to navigate, and contain templates exhibiting standards and starting points.

## 2.4.9 Data Cartridge Development Approach

General Data cartridge development approach.

In developing a data cartridge, take a systematic approach. Start with small, easy tasks and build incrementally toward a comprehensive solution.

### 2.4.9.1 Creating a Data Cartridge Plan

General overview of a plan for creating Data Cartridges.

1. Experiment with the examples in: [Power Demand Cartridge Example](#) , [PSBTREE: Extensible Indexing Example](#), and [Pipelined Table Functions: Interface Approach Example](#).
2. Create the prototype of your own data cartridge, starting with a single user-defined type and a few data elements and methods. You can add user-defined types, data elements, and methods, specific indextypes, and user-defined operators as you expand the cartridge's capabilities.
3. Begin by implementing your methods entirely in SQL, and add callouts to 3GL code later if you need them.
4. Test and debug your cartridge.

### 2.4.9.2 Developing Data Cartridges

A general development process for developing data cartridges

When you have a working prototype you may want to follow a development process that includes the following steps.

1. Identify your areas of domain expertise.
2. Identify those areas of expertise that are relevant to persistent data.
3. Consider the feasibility of packaging one or more of these areas as a new data cartridge or as an extension to an existing cartridge.
4. Use an object-oriented methodology to help decide what object types to include in data cartridges.

5. Build and test the cartridges, one at a time.

# Part II

## Building Data Cartridges

This part describes the processes used to build data cartridge components.

# 3

## Defining Object Types for Data Cartridges

Object types are crucial to building data cartridges in that they enable domain-level abstractions to be captured in the database.

### See Also:

- *Oracle Database Object-Relational Developer's Guide*
- *Oracle Database Concepts*
- *Oracle Database Advanced Application Developer's Guide*
- *Oracle Database PL/SQL Language Reference*

### 3.1 Objects and Object Types for Data Cartridges

In the Oracle Object-Relational Database Management System (ORDBMS), you use object types to model real-world entities. An object type has attributes, which reflect the entity's structure, and methods, which implement the operations on the entity. Attributes are defined using built-in types or other object types. Methods are functions or procedures written in PL/SQL or an external language, like C, and stored in the database.

A typical use for an object type is to impose structure on some part of the data in the database. For example, an object type named `DataStream` could be used by a cartridge to store large amounts of data in a character LOB (a data type for large objects). This object type has attributes such as an identifier, a name, a date, and so on. The statement in [Example 3-1](#) defines the `DataStream` data type:

A method is a procedure or function that is part of the object type definition and that can operate on the object type data attributes. Such methods are called **member methods**, and they take the keyword `MEMBER` when you specify them as a component of the object type. The `DataStream` type definition declares three methods. The first two, `DataStreamMin` and `DataStreamMax`, calculate the minimum and maximum values, respectively, in the data stream stored inside the character LOB. The third method, `DataStreamToInt`, a **map method**, governs comparisons between instances of data stream type.

After declaring the type, define the type body. The body contains the code for type methods. [Example 3-2](#) shows the type body definition for the `DataStream` type. It defines the member function methods, `DataStreamMin` and `DataStreamMax`, and the map method `DataStreamToInt`.

`DataStreamMin` and `DataStreamMax` are call routines in a PL/SQL package named `DS_Package`. Since these methods are likely to be compute-intensive (they process numbers stored in the `CLOB` to determine minimum and maximum values), they are defined as external procedures and implemented in C. The external dispatch is routed



through a PL/SQL package named `DS_Package`. Such packages are discussed in *Oracle Database PL/SQL Packages and Types Reference*. The third method, `DataStreamToInt`, is implemented in PL/SQL. Because we have a identifier, `id`, attribute in `DataStream`, this method can return the value of the identifier attribute. Most map methods, however, are more complex than `DataStreamToInt`.



#### See Also:

- ["Object Comparison"](#) for information about map methods
- [Working with Multimedia Data Types](#)
- *Oracle Database SecureFiles and Large Objects Developer's Guide* for general information about LOBs

## 3.1.1 Defining a DataStream Data Type

### Example 3-1 Defining a DataStream data type

```
create or replace type DataStream as object (
  id integer,
  name varchar2(20),
  createdOn date,
  data clob,
  MEMBER FUNCTION DataStreamMin return pls_integer,
  MEMBER FUNCTION DataStreamMax return pls_integer,
  MAP MEMBER FUNCTION DataStreamToInt return integer;
```

## 3.1.2 Defining the Type Body

### Example 3-2 Defining the Type Body

```
CREATE OR REPLACE TYPE BODY DataStream IS
  MEMBER FUNCTION DataStreamMin return pls_integer is
    a pls_integer := DS_Package.ds_findmin(data);
    begin return a; end;
  MEMBER FUNCTION DataStreamMax return pls_integer is
    b pls_integer := DS_Package.ds_findmax(data);
    begin return b; end;
  MAP MEMBER FUNCTION DataStreamToInt return integer is
    c integer := id;
    begin return c; end;
end;
```

## 3.2 Assigning an Object Identifier to an Object Type in Data Cartridges

The `CREATE TYPE` statement has an optional keyword `OID`, which associates a user-specified object identifier (`OID`) with the type definition. It necessary to anyone who creates an object type used in several database.s

Each type has an `OID`. If you create an object type and do not specify an `OID`, Oracle generates an `OID` and assigns it to the type. Oracle uses the `OID` internally for

operations pertaining to that type. Using the same `OID` for a type is important if you plan to share instances of the type across databases for such operations as export/import and distributed queries.

Note that in `CREATE TYPE` with `OID`, an `OID` is assigned to the type itself. Each row in a table with a column of the specified type has a row-specific `OID`.

Consider creating a `SpecialPerson` type, and then instantiating this type in two different databases in tables named `SpecialPersonTable1` and `SpecialPersonTable2`. The RDBMS must know that the `SpecialPerson` type is the same type in both instances, and therefore the type must be defined using the same `OID` in both databases. If you do not specify an `OID` with `CREATE TYPE`, a unique identifier is created automatically by the RDBMS. The syntax for specifying an `OID` for an object type is in [Example 3-3](#).

In [Example 3-4](#), the `SELECT` statement generates an `OID`, and the `CREATE TYPE` statement uses the `OID` in creating an object type named `mytype`. Be sure to use the `SELECT` statement to generate a different `OID` for each object type to be created, because this is the only way to guarantee that each `OID` is valid and globally unique.

## 3.2.1 Specifying an ODI for an Object Type in Data Cartridges

### Example 3-3 Specifying an ODI for an Object Type

```
CREATE OR REPLACE TYPE type_name OID 'oid' AS OBJECT (attribute datatype [...]);
```

## 3.2.2 Assigning and Using OIDs in Data Cartridges

### Example 3-4 Assigning and Using OIDs

```
SQLPLUS> SELECT SYS_OP_GUID() FROM DUAL;
SYS_OP_GUID()
-----
19A57209ECB73F91E03400400B40BBE3
1 row selected.

SQLPLUS> CREATE TYPE mytype OID '19A57209ECB73F91E03400400B40BBE3'
2> AS OBJECT (attrib1 NUMBER);
Statement processed.
```

## 3.3 Constructor Methods in Data Cartridges

Oracle implicitly defines a **constructor method** for each object type that you define. The name of the constructor method is identical to the name of the object type. The parameters of the constructor method are exactly the data attributes of the object type, and they occur in the same order as the attribute definition for the object type. Only one constructor method can be defined for each object type.

In [Example 3-5](#), the system creates a type named `rational_type` and implicitly creates a constructor method for this object type.

When you instantiate an object of `rational_type`, you invoke the constructor method, as demonstrated in [Example 3-6](#):

## 3.3.1 Creating a Type

### Example 3-5 Creating a Type

```
CREATE TYPE rational_type (  
    numerator integer,  
    denominator integer);
```

## 3.3.2 Instantiating a Type Object

### Example 3-6 Instantiating a Type Object

```
CREATE TABLE some_table (  
    c1 integer, c2 rational_type);  
INSERT INTO some_table  
VALUES (42, rational_type(223, 71));
```

## 3.4 Object Comparison in Data Cartridges

SQL performs comparison operations on objects. Some comparisons are explicit, using the comparison operators (`=`, `<`, `>`, `<>`, `<=`, `>=`, `!=`) and the `BETWEEN` and `IN` predicates. Other comparisons are implicit, as in the `GROUP BY`, `ORDER BY`, `DISTINCT`, and `UNIQUE` clauses.

Comparison of objects uses special member functions of the object type: `map` methods and `order` methods. To perform object comparison, you must implement either a `map` method or an `order` method in the `CREATE TYPE` and `CREATE TYPE BODY` statements. In [Example 3-7](#), the type body for the `DataStream` type implements the `map` member function.

The definition of the `map` member function relies on the presence of the `id` attribute of the `DataStream` type to map instances to integers. Whenever a comparison operation is required between objects of type `DataStream`, the `map` function `DataStreamToInt()` is called implicitly by the system.

The object type `rational_type` does not have a simple `id` attribute like `DataStream`. Instead, its `map` member function is complicated, as demonstrated in [Example 3-8](#). Because a `map` function can return any of the built-in types, `rational_type` can return a value or type `REAL`.

If you have not defined a `map` or `order` function for an object type, it can only support equality comparisons. Oracle SQL performs the comparison by doing a field-by-field comparison of the attributes of that type.

### 3.4.1 Implementing a Member Function

#### Example 3-7 Implementing a Member Function

```
MAP MEMBER FUNCTION DataStreamToInt return integer is  
    c integer := id;  
begin return c; end;
```

## 3.4.2 Implementing Functions for Types Without a Simple Id Attribute

### **Example 3-8 Implementing Functions for Types Without a Simple Id Attribute**

```
MAP MEMBER FUNCTION RationalToReal RETURN REAL IS
    BEGIN
        RETURN numerator/denominator;
    END;
...

```

# 4

## Implementing Data Cartridges in PL/SQL

You can use PL/SQL to implement data cartridge methods. Methods are procedures and functions that define the operations permitted on data defined using the data cartridge.

### 4.1 Methods

A **method** is procedure or function that is part of the object type definition, and that can operate on the attributes of the type. Such methods are also called **member methods**, and they take the keyword `MEMBER` when you specify them as a component of the object type.

Consider simple examples for implementing a method, invoking a method, and referencing an attribute in a method.

#### See Also:

- *Oracle Database Concepts* for information about method specifications, names, and overloading
- *Oracle Database PL/SQL Language Reference* for further explanation and examples

#### 4.1.1 Implementing Methods

To implement a method, create the PL/SQL code and specify it within a `CREATE TYPE BODY` statement. If an object type has no methods, no `CREATE TYPE BODY` statement for that object type is required.

[Example 4-1](#) demonstrates the definition of an object type `rational_type`.

The definition in [Example 4-2](#) defines the function `gcd`, which is used in the definition of the `normalize` method in the `CREATE TYPE BODY` statement.

The statements in [Example 4-3](#) implement the methods `rat_to_real`, `normalize`, and `plus` for the object type `rational_type`.

##### 4.1.1.1 Defining an Object Type

###### **Example 4-1** Defining an Object Type

```
CREATE TYPE rational_type AS OBJECT
( numerator INTEGER,
  denominator INTEGER,
  MAP MEMBER FUNCTION rat_to_real RETURN REAL,
  MEMBER PROCEDURE normalize,
```

```
MEMBER FUNCTION plus (x rational_type)
    RETURN rational_type);
```

### 4.1.1.2 Defining a “Greatest Common Divisor” Function

#### Example 4-2 Defining a “Greatest Common Divisor” Function

```
CREATE FUNCTION gcd (x INTEGER, y INTEGER) RETURN INTEGER AS
-- Find greatest common divisor of x and y. For example, if
-- (8,12) is input, the greatest common divisor is 4.
-- This normalizes (simplifies) fractions.
-- (You need not try to understand how this code works, unless
-- you are a math wizard. It does.)
--
    ans INTEGER;
BEGIN
    IF (y <= x) AND (x MOD y = 0) THEN
        ans := y;
    ELSIF x < y THEN
        ans := gcd(y, x); -- Recursive call
    ELSE
        ans := gcd(y, x MOD y); -- Recursive call
    END IF;
    RETURN ans;
END;
```

### 4.1.1.3 Implementing Methods for an Object Type

#### Example 4-3 Implementing Methods for an Object Type

```
CREATE TYPE BODY rational_type
( MAP MEMBER FUNCTION rat_to_real RETURN REAL IS
    -- The rat-to-real function converts a rational number to
    -- a real number. For example, 6/8 = 0.75
    BEGIN
        RETURN numerator/denominator;
    END;

    -- The normalize procedure simplifies a fraction.
    -- For example, 6/8 = 3/4
    MEMBER PROCEDURE normalize IS
        divisor INTEGER := gcd(numerator, denominator);
    BEGIN
        numerator := numerator/divisor;
        denominator := denominator/divisor;
    END;

    -- The plus function adds a specified value to the
    -- current value and returns a normalized result.
    -- For example, 1/2 + 3/4 = 5/4
    --
    MEMBER FUNCTION plus(x rational_type)
        RETURN rational_type IS
        -- Return sum of SELF + x
    BEGIN
        r = rational_type(numerator*x.denominator +
            x.numerator*denominator,
            denominator*x.denominator);
        -- Example adding 1/2 to 3/4:
        -- (3*2 + 1*4) / (4*2)
```

```

-- Now normalize (simplify). Here, 10/8 = 5/4
r.normalize;
RETURN r;
END;
END;

```

## 4.1.2 Invoking Methods

To invoke a method, use the syntax in [Example 4-4](#).

In SQL statements only, you can use the syntax in [Example 4-5](#).

[Example 4-6](#) shows how to invoke a method named `get_emp_sal` in PL/SQL.

An alternative way to invoke a method is by using the `SELF` built-in parameter. Because the implicit first parameter of each method is the name of the object on whose behalf the method is invoked, [Example 4-7](#) performs the same action as the `salary := employee.get_emp_sal();` line in [Example 4-6](#).

In [Example 4-7](#), `employee` is the name of the object on whose behalf the `get_emp_sal()` method is invoked.

### 4.1.2.1 General Syntax for Invoking Methods

#### Example 4-4 Invoking Methods; General Syntax

```
object_name.method_name([parameter_list])
```

### 4.1.2.2 SQL Syntax for Invoking Methods

#### Example 4-5 Invoking Methods; SQL Syntax

```
correlation_variable.method_name([parameter_list])
```

### 4.1.2.3 PL/SQL Syntax for Invoking Methods

#### Example 4-6 Invoking Methods; PL/SQL Syntax

```

DECLARE
  employee employee_type;
  salary number;
  ...
BEGIN
  salary := employee.get_emp_sal();
  ...
END;

```

### 4.1.2.4 Using the SELF Build-In Parameter

#### Example 4-7 Using the SELF Build-In Parameter

```
salary := get_emp_sal(SELF => employee);
```

## 4.1.3 Referencing Attributes in a Method

Because member methods can reference the attributes and member methods of the same object type without using a qualifier, a built-in reference, `SELF`, always identifies the object on whose behalf the method is invoked.

Consider [Example 4-8](#), where two statements set the value of variable `var1` to 42.

The statements `var1 := 42` and `SELF.var1 := 42` have the same effect. Because `var1` is the name of an attribute of the object type `a_type` and because `set_var1` is a member method of this object type, no qualification is required to access `var1` in the method code. However, for code readability and maintainability, you can use the keyword `SELF` in this context to make the reference to `var1` more clear.

### 4.1.3.1 Setting Variable Values

#### Example 4-8 Setting Variable Values

```
CREATE TYPE a_type AS OBJECT (  
    var1 INTEGER,  
    MEMBER PROCEDURE set_var1);  
CREATE TYPE BODY a_type (  
    MEMBER PROCEDURE set_var1 IS  
    BEGIN  
        var1 := 42;  
        SELF.var1 := 42;  
    END set_var1;  
);
```

## 4.2 Debugging PL/SQL Code

One of the simplest ways to debug PL/SQL code is to try each method, block, or statement interactively using SQL\*Plus, and fix any problems before proceeding to the next statement. If you need more information on an error message, enter the statement `SHOW ERRORS`. Also, consider displaying statements for run-time debugging. You can debug stored procedures and packages using the `DBMS_OUTPUT` package, by inserting `PUT` and `PUTLINE` statements into the code to output the values of variables and expressions to your terminal, as demonstrated in [Example 4-9](#).

A PL/SQL tracing tool provides more information about exception conditions in application code. You can use this tool to trace the execution of server-side PL/SQL statements. Object type methods cannot be traced directly, but you can trace any PL/SQL functions or procedures that a method calls. The tracing tool also provides information about exception conditions in the application code. The trace output is written to the Oracle server trace file. Note that only the database administrator has access to the file.



 **See Also:**

- The *Oracle Database SQL Tuning Guide* describes the tracing tool
- The *Oracle Database PL/SQL Packages and Types Reference* and the *Oracle Database PL/SQL Language Reference* describe the `DBMS_OUTPUT` package

**Example 4-9 Outputting Variable Values to the Terminal, for Debugging**

```
Location in module: location
Parameter name: name
Parameter value: value
```

## 4.2.1 Notes for C and C++ Developers of Data Cartridges

If you are a C or C++ programmer, several PL/SQL conventions and requirements may differ from your expectations.

- `=` means equal (not assign).
- `:=` means assign (as in Algol).
- `VARRAYs` begin at index 1 (not 0).
- Comments begin with two hyphens (`--`), not with `//` or `/*`.
- The `IF` statement requires the `THEN` keyword.
- The `IF` statement must be concluded with the `END IF` keyword (which comes after the `ELSE` clause, if there is one).
- There is no `PRINTF` statement. The comparable feature is the `DBMS_OUTPUT.PUT_LINE` statement. In this statement, literal and variable text is separated using the double vertical bar, `||`.
- A function must have a return value, and a procedure cannot have a return value.
- If you call a function, it must be on the right side of an assignment operator.
- Many PL/SQL keywords cannot be used as variable names.

## 4.2.2 Common Potential Errors

Several kinds of errors that may occur while creating a data cartridge.

### 4.2.2.1 Signature Mismatches

```
13/19 PLS-00538: subprogram or cursor '<name>' is declared in an object
type specification and must be defined in the object type body
15/19 PLS-00539: subprogram '<name>' is declared in an object type body
and must be defined in the object type specification
```

If you see either or both of these messages, you have made an error with the signature for a procedure or function. In other words, you have a mismatch between the function or procedure prototype that you entered in the object specification, and the definition in the object body.

Ensure that parameter orders, parameter spelling (including case), and function returns are identical. Use copy-and-paste to avoid errors in typing.

### 4.2.2.2 RPC Time Out

```
ORA-28576: lost RPC connection to external procedure agent
ORA-06512: at "<name>", line <number>
ORA-06512: at "<name>", line <number>
ORA-06512: at line 34
```

This error might occur after you exit the debugger for the DLL. Restart the program outside the debugger.

### 4.2.2.3 Package Corruption

```
ERROR at line 1:
ORA-04068: existing state of packages has been discarded
ORA-04063: package body "<name>" has errors
ORA-06508: PL/SQL: could not find program unit being called
ORA-06512: at "<name>", line <number>
ORA-06512: at line <number>
```

This error might occur if you are extending an existing data cartridge; it indicates that the package has been corrupted and must be recompiled.

Before you can perform the recompilation, you must delete all tables and object types that depend upon the package that you are recompiling. To find the dependents on a Windows NT system, use the Oracle Administrator toolbar. Click the Schema button, log in as `sys\change_on_install`, and find packages and tables that you created. Drop these packages and tables by entering SQL statements in the SQL\*Plus interface, as shown in [Example 4-10](#):

#### Example 4-10 Dropping Packages and Tables

```
Drop type type_name;
Drop table table_name cascade constraints;
```

The recompilation can then be done using the SQL statements in [Example 4-11](#):

#### Example 4-11 Recompiling Packages

```
Alter type type_name compile body;
Alter type type_name compile specification;
```

# 5

## Implementing Data Cartridges in C, C++, and Java

You can use C, C++, and Java to implement data cartridge methods. Methods are procedures and functions that define the operations permitted on data defined using the data cartridge. The focus is on issues related to developing and debugging external procedures.

### 5.1 Shared Libraries

A **shared library** is an operating system file, such as a Windows DLL or a Solaris shared object, which stores the coded implementation of external procedures. You can access the shared library from Oracle by using an **alias library**, which is a schema object that represents the library within PL/SQL. For security reasons, you need DBA privileges to create an alias library.

#### See Also:

- *Oracle Database PL/SQL Language Reference* for more information on using dedicated external procedure agents
- *Oracle Database Security Guide* for more information on Directory Object support for libraries

#### 5.1.1 Using Shared Libraries

To create the alias library, you must decide on the operating system location for the library, log in as a DBA or as a user with the `CREATE LIBRARY` privilege, and then enter the statement in [Example 5-1](#). This creates the alias library schema object in the database. After the alias library is created, you can refer to the shared library by the name `DS_Lib` from PL/SQL. [Example 5-1](#) specifies an absolute path for the library.

If you have copies of the library on multiple systems, to support distributed execution of external procedures by designated or dedicated agents, use an environment variable to specify the location of the libraries more generally, as in [Example 5-2](#). This statement uses the environment variable `${DS_LIB_HOME}` to specify a common point of reference or root directory from which the library can be found on all systems. The string following the `AGENT` keyword specifies the agent (actually, a database link) that is used to run any external procedure declared to be in library `DS_Lib`.

Oracle Database 12c Release 1 (12.1) introduces two extensions to the `CREATE LIBRARY` syntax: an additional optional `CREDENTIAL` option and a `DIRECTORY` object option. The credential option specifies the credentials of the operating system user that the `extproc` agent impersonates when running an external subprogram that specifies the

library. The directory object option specifies the directory where the shared library can be found.

**Example 5-3** specifies a directory object option instead of a full path string; it also specifies an optional credential argument. When an external procedure call through the `extproc` process loads the PL/SQL library, `extproc` can authenticate and 'impersonate' on behalf of the defined `smith_credential` credential.

Note that if the directory or the credential does not exist when calling `CREATE LIBRARY` statement, the library is created with errors.

### 5.1.1.1 Creating an Alias Library

#### Example 5-1 Creating an Alias Library

```
CREATE OR REPLACE LIBRARY DS_Lib AS
  '/data_cartridge_dir/libdatastream.so';
```

### 5.1.1.2 Specifying the Location of the Library

#### Example 5-2 Specifying the Location of the Library Using an Environment Variable

```
CREATE OR REPLACE LIBRARY DS_Lib AS
  '${DS_LIB_HOME}/libdatastream.so' AGENT 'agent_link';
```

### 5.1.1.3 Creating an Alias Library through Directory Objects

#### Example 5-3 Creating an Alias Library Using the Directory Object Option

```
CREATE OR REPLACE LIBRARY DS_Lib AS
  'libdatastream.so' IN data_cartridge_dir AGENT 'sales.hq.example.com'
  CREDENTIAL smith_credential;
```

## 5.2 External Procedures

PL/SQL is a powerful language for database programming, but some methods are too complex to code optimally in PL/SQL. For example, a routine to perform numeric integration probably runs faster if it is implemented in C rather than PL/SQL.

To support such special-purpose processing, PL/SQL provides an interface for calling routines written in other languages. This makes the strengths and capabilities of 3GLs, like C, available through calls from a database server. Such a 3GL routine is called an **external procedure**; it is stored in a shared library, registered with PL/SQL, and called from PL/SQL at run time.

External procedures are an important tool for data cartridge developers. They can be used not only to write fast, efficient, computation-intensive routines for cartridge types, but also to integrate existing code with the database as data cartridges. Existing shared libraries from other languages, such as a Windows NT DLL with C routines to perform format conversions for audio files, can be called directly from a method in a type implemented by an audio cartridge. Similarly, you can use external procedures to process signals, drive devices, analyze data streams, render graphics, or process numeric data.

 **See Also:**

*PL/SQL User's Guide and Reference* for details on external procedures and their use

## 5.2.1 Registering an External Procedure

To call an external procedure, you must not only instruct PL/SQL regarding the alias library where the external procedure is defined, but also how to call this procedure and what arguments to pass to it.

The `DataStream` type was defined in [Example 3-1](#), and [Example 3-2](#) defined methods of `DataStream` by calling functions from the `DS_Package` package. [Example 5-4](#) defines the body of this package.

Note that in the `PACKAGE BODY` declaration clause, the package functions are tied to external procedures in a shared library. The `EXTERNAL` clause in the function declaration registers information about the external procedure, such as its name (found after the `NAME` keyword), its location (which must be an alias library, following the `LIBRARY` keyword), the language in which the external procedure is written (following the `LANGUAGE` keyword), and so on.

The final part of the `EXTERNAL` clause in the example is the `WITH CONTEXT` specification. Here, a context pointer is passed to the external procedure. The context pointer is opaque to the external procedure, but is available so that the external procedure can call back to the Oracle server, to potentially access more data in the same transaction context.

Although the example describes external procedure calls from object type methods, a data cartridge can use external procedures from a variety of other places in PL/SQL. External procedure calls can appear in:

- Anonymous blocks
- Standalone and packaged subprograms
- Methods of an object type
- Database triggers
- SQL statements (calls to packaged functions only)

 **See Also:**

- Description of the parameters that can accompany an `EXTERNAL` clause in *PL/SQL User's Guide and Reference*.

Information about external procedures and formatting the call specification when passing an object type to a C routine in *Oracle Database Advanced Application Developer's Guide*

- The `WITH CONTEXT` clause in "[Using the WITH CONTEXT Clause](#)".

### 5.2.1.1 Defining the Body of a Package

#### Example 5-4 Defining the Body of a Package

```
CREATE OR REPLACE PACKAGE BODY DS_Package AS
    FUNCTION DS_Findmin(data CLOB) RETURN PLS_INTEGER IS EXTERNAL
    NAME "c_findmin" LIBRARY DS_Lib LANGUAGE C WITH CONTEXT;
    FUNCTION DS_Findmax(data CLOB) RETURN PLS_INTEGER IS EXTERNAL
    NAME "c_findmax" LIBRARY DS_Lib LANGUAGE C WITH CONTEXT;
END;
```

## 5.3 How PL/SQL Calls an External Procedure

To call an external procedure, PL/SQL must know the DLL or shared library in which the procedure resides. PL/SQL looks up the alias library in the `EXTERNAL` clause of the subprogram that registered the external procedure. The data dictionary is used to determine the actual path to the operating system shared library or DLL.

PL/SQL alerts a Listener process, which in turn starts a session-specific agent. Unless some other particular agent has been designated either in the `CREATE LIBRARY` statement for the procedure's specified library or in the agent argument of the `CREATE PROCEDURE` statement, the default agent `extproc` is launched. The Listener hands over the connection to the agent. PL/SQL passes the agent the name of the DLL, the name of the external procedure, and any parameters passed in by the caller. The rest of this account assumes that the agent launched is the default agent `extproc`.

After receiving the name of the DLL and the external procedure, `extproc` loads the DLL and runs the external procedure. Also, `extproc` handles service calls, such as raising an exception, and callbacks to the Oracle server. Finally, `extproc` passes to PL/SQL any values returned by the external procedure. [Figure 5-1](#) shows the flow of control.

**Figure 5-1 Calling an External Procedure**

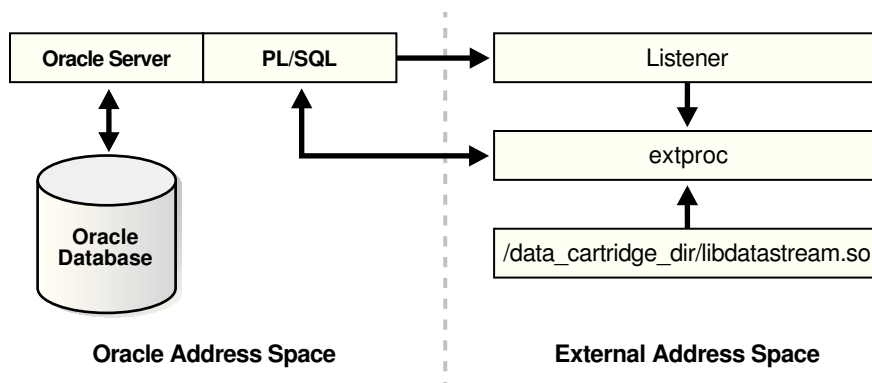

After the external procedure completes, `extproc` remains active throughout your Oracle session. Thus, you incur the cost of spawning `extproc` only one time, no matter how many calls you make. Still, you should call an external procedure only when the computational benefits outweigh the cost. When you log off, `extproc` is killed.

Note that the Listener must start `extproc` on the system that runs the Oracle server. Starting `extproc` on a different system is not supported.

 **See Also:**

- *Oracle Database PL/SQL Language Reference* for more information on using dedicated external procedure agents to run an external procedure
- *Oracle Database Administrator's Guide* for information about administering `extproc` and external procedure call

## 5.4 Configuring Files for External Procedures

The configuration files `listener.ora` and `tnsnames.ora` must have appropriate entries, so that the Listener can dispatch the external procedures.

The Listener configuration file `listener.ora` must have a `SID_DESC` entry for the external procedure, as demonstrated in [Example 5-5](#).

[Example 5-5](#) assumes the following:

- The Oracle instance is called `o10`.
- The system or node on which the Oracle server runs is named `unix123`.
- The installation directory for the Oracle server is `/rdbms/u01`.
- The port number for Oracle TCP/IP communication is the default Listener port 1521.

The `tnsnames.ora` file is the network substrate configuration file, and it must also be updated to refer to the external procedure, as demonstrated in [Example 5-6](#).

[Example 5-6](#) assumes that IPC mechanisms are used to communicate with the external procedure. You can also use, for example, TCP/IP for communication, in which case the `PROTOCOL` parameter must be set to `tcp`.

 **See Also:**

*Oracle Database Administrator's Guide* for more information about configuring the `listener.ora` and `tnsnames.ora` files

### 5.4.1 Updating the Listener Configuration File

#### Example 5-5 Setting the `SID_DESC` Entry in the Listener Configuration File

```
# Listener configuration file
# This file is generated by stkconf.tsc

CONNECT_TIMEOUT_LISTENER = 0

LISTENER = (ADDRESS_LIST=
  (ADDRESS=(PROTOCOL=ipc)(KEY=o10))
  (ADDRESS=(PROTOCOL=tcp)(HOST=unix123)(PORT=1521))
)
```

```
SID_LIST_LISTENER = (SID_LIST=
  SID_DESC=(SID_NAME=o10)(ORACLE_HOME=/rdbs/u01/app/oracle/product/11.2.0.1.0)
  SID_DESC=(SID_NAME=extproc)
    (ORACLE_HOME=/rdbs/u01/app/oracle/product/11.2.0.1.0)
  (PROGRAM=extproc))
```

## 5.4.2 Directing Network to Refer to External Procedures

### Example 5-6 Updating the Network Substrate Configuration to Refer to External Procedures

```
o10 = (DESCRIPTION=(ADDRESS=(PROTOCOL=tcp)(HOST=unix123)(PORT=1521))
  (CONNECT_DATA=(SID=o10)))
extproc_connection_data = (DESCRIPTION=(ADDRESS=(PROTOCOL=ipc)(KEY=o10))
  CONNECT_DATA=(SID=extproc))
```

## 5.4.3 Passing Parameters to an External Procedure

Passing parameters to an external procedure is complicated by several circumstances:

- The set of PL/SQL data types does not correspond one-to-one with the set of C data types.
- PL/SQL parameters can be `null`, whereas C parameters cannot. Unlike C, PL/SQL includes the RDBMS concept of nullity.
- The external procedure might need the current length or maximum length of `CHAR`, `LONG RAW`, `RAW`, and `VARCHAR2` parameters.
- The external procedure might need character set information about `CHAR`, `VARCHAR2`, and `CLOB` parameters.
- PL/SQL might need the current length, maximum length, or null status of values returned by the external procedure.

Consider how to best specify a parameter list that deals with these circumstances. An example of parameter passing is shown in [Example 5-7](#), where the package function `DS_Findmin(data CLOB)` calls the C routine `c_findmin` and the `CLOB` argument is passed to the C routine as an `OCIlobLocator()`.

## 5.4.4 Specifying Data Types

You do not pass parameters to an external procedure directly. Instead, you pass them to the PL/SQL subprogram that registered the external procedure. So, you must specify PL/SQL data types for the parameters. [Table 5-1](#) maps each PL/SQL data type to a default external data type. The external data types map to C data type.

In some cases, you can use the `PARAMETERS` clause to override the default data type mappings. For example, you can re-map the PL/SQL data type `BOOLEAN` from external data type `INT` to external data type `CHAR`.

To avoid errors when declaring C prototype parameters, refer to [Table 5-2](#), which shows the C data type to specify for a given external data type and PL/SQL parameter mode. For example, if the external data type of an `OUT` parameter is `CHAR`, specify the data type `char*` in your C prototype.



### 5.4.4.1 Conversion to External Datatypes

**Table 5-1 Parameter Datatype Mappings**

PL/SQL Type	Supported External Types	Default External Type
BINARY_INTEGER, BOOLEAN, PLS_INTEGER	CHAR, UNSIGNED CHAR, SHORT, UNSIGNED SHORT, INT, UNSIGNED INT, LONG, UNSIGNED LONG, SB1, UB1, SB2, UB2, SB4, UB4, SIZE_T	INT
NATURAL, NATURALN, POSITIVE, POSITIVEN, SIGNTYPE	CHAR, UNSIGNED CHAR, SHORT, UNSIGNED SHORT, INT, UNSIGNED INT, LONG, UNSIGNED LONG, SB1, UB1, SB2 ,UB2, SB4, UB4, SIZE_T	UNSIGNED INT
FLOAT, REAL	FLOAT	FLOAT
DOUBLE PRECISION	DOUBLE	DOUBLE
CHAR, CHARACTER, LONG, ROWID, VARCHAR, VARCHAR2	STRING	STRING
LONG RAW, RAW	RAW	RAW
BFILE, BLOB, CLOB	OCILOBLOCATOR	OCILOBLOCATOR

### 5.4.4.2 Conversion from External Datatypes

**Table 5-2 External Data Type Mappings**

External Data Type	IN, RETURN	IN by Reference, RETURN by Reference	IN OUT, OUT
CHAR	char	char *	char *
UNSIGNED CHAR	unsigned char	unsigned char *	unsigned char *
SHORT	short	short *	short *
UNSIGNED SHORT	unsigned short	unsigned short *	unsigned short *
INT	int	int *	int *
UNSIGNED INT	unsigned int	unsigned int *	unsigned int *

**Table 5-2 (Cont.) External Data Type Mappings**

External Data Type	IN, RETURN	IN by Reference, RETURN by Reference	IN OUT, OUT
LONG	long	long *	long *
UNSIGNED LONG	unsigned long	unsigned long *	unsigned long *
SIZE_T	size_t	size_t *	size_t *
SB1	sb1	sb1 *	sb1 *
UB1	ub1	ub1 *	ub1 *
SB2	sb2	sb2 *	sb2 *
UB2	ub2	ub2 *	ub2 *
SB4	sb4	sb4 *	sb4 *
UB4	ub4	ub4 *	ub4 *
FLOAT	float	float *	float *
DOUBLE	double	double *	double *
STRING	char *	char *	char *
RAW	unsigned char *	unsigned char *	unsigned char *
OCILOBLOCATOR	OCILOBLocator *	OCILOBLocator *	OCILOBLocator **

## 5.4.5 Using the Parameters Clause

You can optionally use the `PARAMETERS` clause to pass additional information about PL/SQL formal parameters and function return values to an external procedure. You can also use this clause to reposition parameters.



### See Also:

*Oracle Database PL/SQL Language Reference.*

## 5.4.6 Using the WITH CONTEXT Clause

When launched, an external procedure must access the database. For example, `DS_Findmin` does not copy the entire `CLOB` data over to `c_findmin`, because doing so would vastly increase the amount of stack that the C routine needs. Instead, the PL/SQL function just passes a `LOB` locator to the C routine, with the intent that the database is accessed again from C to read the actual `LOB` data.

When the C routine reads the data, it can use the OCI buffering and streaming interfaces associated with LOBs, so that only incremental amounts of stack are needed. Such re-access of the database from an external procedure is known as a **callback**.

To be able to call back to a database, you must use the `WITH CONTEXT` clause to give the external procedure access to the database environment, service, and error handles. When an external procedure is called using `WITH CONTEXT`, the corresponding C routine automatically gets an argument of type `OCIExtProcContext*` as its first parameter. The order of the parameters can be changed using the `PARAMETERS` clause. You can use this context pointer to fetch the handles using the `OCIExtProcGetEnv` call, and then call back to the database. This procedure is shown in [Example 5-7](#).

### See Also:

*Oracle Call Interface Programmer's Guide* for details about OCI callbacks

## 5.5 Using Callbacks

An external procedure that runs on the Oracle server can call the access function `OCIExtProcGetEnv()` to obtain the OCI environment and service handles. With the OCI, you can use callbacks to execute SQL statements and PL/SQL subprograms, fetch data, and manipulate LOBs. Moreover, callbacks and external procedures operate in the same user session and transaction context, so they have the same user privileges.

[Example 5-7](#) is a version of `c_findmin` that is simplified to illustrate callbacks.

### Example 5-7 Using Callbacks

```
Static OCIEnv *envhp;
Static OCISvcCtx *svchp;
Static OCIError *errhp;
Int c_findmin (OCIExtProcContext *ctx, OCILOBLocator *lobl) {
sword retval;
retval = OCIExtProcGetEnv (ctx, &envhp, &svchp, &errhp);
if ((retval != OCI_SUCCESS) && (retval != OCI_SUCCESS_WITH_INFO))
    exit(-1);
/* Use lobl to read the CLOB, compute the minimum, and store the value
in retval. */
return retval;
}
```

## 5.5.1 Restrictions on Callbacks

With callbacks, the following SQL statements and OCI routines are not supported:

- Transaction control statements such as `COMMIT`
- Data definition statements such as `CREATE`
- Object-oriented OCI routines such as `OCIRefClear`
- Polling-mode OCI routines such as `OCIGetPieceInfo`
- The following OCI routines:
  - `OCIEnvInit()`
  - `OCIInitialize()`
  - `OCIPasswordChange()`
  - `OCIserverAttach()`
  - `OCIserverDetach()`
  - `OCISessionBegin ()`
  - `OCISessionEnd ()`
  - `OCISvcCtxToLda()`
  - `OCITransCommit()`
  - `OCITransDetach()`
  - `OCITransRollback()`
  - `OCITransStart()`
- Also, with OCI routine `OCIHandleAlloc()`, the following handle types are not supported:
  - `OCI_HTYPE_SERVER`
  - `OCI_HTYPE_SESSION`
  - `OCI_HTYPE_SVCCTX`
  - `OCI_HTYPE_TRANS`

## 5.6 Common Potential Errors

Consider several common errors that may occur when running external procedures.

### 5.6.1 Calls to External Functions

You may have specified the wrong path or wrong name for the DLL file, or you may have tried to use a DLL on a network mounted drive (a remote drive).

```
Can't Find DLL
ORA-06520: PL/SQL: Error loading external library
ORA-06522: Unable to load DLL
ORA-06512: at "<name>", line <number>
ORA-06512: at "<name>", line <number>
ORA-06512: at line <number>
```

## 5.6.2 RPC Time Out

This error might occur after you exit a debugger while debugging a shared library or DLL. Simply disconnect your client and reconnect to the database.

```
ORA-28576: lost RPC connection to external procedure agent
ORA-06512: at "<name>", line <number>
ORA-06512: at "<name>", line <number>
ORA-06512: at line <number>
```

## 5.7 Debugging External Procedures

Usually, when an external procedure fails, its C prototype is faulty. That is, the prototype does not match the one generated internally by PL/SQL. This can happen if you specify an incompatible C data type. For example, to pass an `OUT` parameter of type `REAL`, you must specify `float *`. Specifying `float`, `double *`, or any other C data type, results in a mismatch.

In such cases, you might get a lost RPC connection to external procedure agent error, which means that agent `extproc` terminated abnormally because the external procedure caused a core dump. To avoid errors when declaring C prototype parameters, refer to [Table 5-2](#).

### 5.7.1 Using Package `DEBUG_EXTPROC`

To help you debug external procedures, PL/SQL provides the utility package `DEBUG_EXTPROC`. To install the package, run the script `dbgextp.sql`, which you can find in the PL/SQL demo directory.

To use the package, follow the instructions in `dbgextp.sql`. Your Oracle account must have `EXECUTE` privileges on the package and `CREATE LIBRARY` privileges.

Note that `DEBUG_EXTPROC` works only on platforms with debugger utilities that can attach to a running process.

### 5.7.2 Debugging C Code in DLLs on Windows NT Systems

If you are developing on a Windows NT system, you may perform the following additional actions to debug external procedures:

1. Invoke the Windows NT Task Manager; press **Ctrl+Alt+Del** and select **Task Manager**.
2. In the Processes display, select `ExtProc.exe`.
3. Right click, and select **Debug**.
4. Select **OK** in the message box.

At this point, if you have built your DLL in a debug fashion with Microsoft Visual C++, Visual C++ is activated.

5. In the Visual C++ window, select **Edit > Breakpoints**.
6. Use the breakpoint identified in `dbgextp.sql` in the PL/SQL demo directory.

## 5.8 Guidelines for Using External Procedures with Data Cartridges

Make sure to write thread-safe external procedures. In particular, avoid using static variables, which can be shared by routines running in separate threads.

For help in creating a dynamic link library, look in the RDBMS subdirectory `/public`, where a template `makefile` can be found.

When calling external procedures, never write to `IN` parameters or overflow the capacity of `OUT` parameters. PL/SQL does no run-time checks for these error conditions. Likewise, never read an `OUT` parameter or a function result. Also, always assign a value to `IN OUT` and `OUT` parameters and to function results. Otherwise, your external procedure does not return successfully.

If you include the `WITH CONTEXT` and `PARAMETERS` clauses, you must specify the parameter `CONTEXT`, which shows the position of the context pointer in the parameter list. If you omit the `PARAMETERS` clause, the context pointer is the first parameter passed to the external procedure.

If you include the `PARAMETERS` clause and the external procedure is a function, you must specify the parameter `RETURN` (not `RETURN` property) in the last position.

For every formal parameter, there must be a corresponding parameter in the `PARAMETERS` clause. Also, ensure that the data types of parameters in the `PARAMETERS` clause are compatible with those in the C prototype, because no implicit conversions are done.

A parameter for which you specify `INDICATOR` or `LENGTH` has the same parameter mode as the corresponding formal parameter. However, a parameter for which you specify `MAXLEN`, `CHARSETID`, or `CHARSETFORM` is always treated like an `IN` parameter, even if you also specify `BY REFERENCE`.

With a parameter of type `CHAR`, `LONG RAW`, `RAW`, or `VARCHAR2`, you must use the property `LENGTH`. Also, if that parameter is `IN OUT` or `OUT` and null, you must set the length of the corresponding C parameter to zero.



### See Also:

For more information about multithreading, see the *Oracle Database Heterogeneous Connectivity Administrator's Guide*.

## 5.9 Java Methods

To use Java Data Cartridges, it is important that you know how to load Java class definitions, about how to call stored procedures, and about context management.

 **See Also:**

[Cartridge Services Using C, C++ and Java](#) for information on ODCI classes.

# 6

## Working with Multimedia Data Types

Multimedia data types, are represented in Oracle Database as Large Objects (LOBs). You can implement them in PL/SQ and OCI for Data Cartridges.

### 6.1 Overview of Cartridges and Multimedia Data Types

Some data cartridges must handle large amounts of raw binary data, such as graphic images or sound waveforms, or character data, such as text or streams of numbers. Oracle supports large objects, LOBs, to handle these kinds of data.

- **Internal LOBs** are stored in the database tablespaces in a way that optimizes space and provides efficient access. Internal LOBs participate in the transactional model of the server.

Internal LOBs can store binary data (BLOBs), single-byte character data (CLOBs), or fixed-width single-byte or multibyte character data (NCLOBs). An NCLOB consists of character data that corresponds to the national character set defined for the Oracle database. Varying width character data is not supported in Oracle.

- **External LOBs** are stored in operating system files outside the database tablespaces as BFILES, binary data. They cannot participate in transactions.

Both internal LOBs and in BFILES provide considerable flexibility in handling large amounts of data.

Data stored in a LOB is called the LOB's **value**. To the Oracle server, a LOB's value is unstructured and cannot be queried. You must unpack and interpret a LOB's value in cartridge-specific ways.

LOBs can be manipulated using the Oracle Call Interface, OCI, or the PL/SQL DBMS\_LOB package. You can write functions, including methods on object types that can contain LOBs, to manipulate parts of LOBs.

#### See Also:

*Oracle Database SecureFiles and Large Objects Developer's Guide* for details on LOBs

### 6.2 Using DDL for LOBs

LOB definition can involve the CREATE TYPE and the CREATE TABLE statements.

**Example 6-1** specifies a CLOB within a data type named lob\_type.

**Example 6-2** creates an object table, lob\_table, in which each row is an instance of lob\_type data:



[Example 6-3](#) shows how to store LOBs in a regular table, as opposed to an object table as in [Example 6-2](#).

When creating LOBs in tables, you can set the LOB storage, buffering, and caching properties.

#### See Also:

*Oracle Database SQL Language Reference* manual and the *Oracle Database SecureFiles and Large Objects Developer's Guide* for information about using LOBs in CREATE TABLE, ALTER TABLE, CREATE TYPE and ALTER TYPE statements

## 6.2.1 Creating a LOB Attribute of a Type

### Example 6-1 Creating a CLOB Attribute of a Type

```
CREATE OR REPLACE TYPE lob_type AS OBJECT (  
  id INTEGER,  
  data CLOB );
```

## 6.2.2 Creating a LOB Object Table

### Example 6-2 Creating a LOB Object Table

```
CREATE TABLE lob_table OF lob_type;
```

## 6.2.3 Creating LOB Columns

### Example 6-3 Creating LOB Columns in a Table

```
CREATE TABLE lob_table1 (  
  id INTEGER,  
  b_lob BLOB,  
  c_lob CLOB,  
  nc_lob NCLOB,  
  b_file BFILE );
```

## 6.3 LOB Locators

LOBs can be stored with other row data or separate from row data. Regardless of the storage location, each LOB has a **locator**, which can be viewed as a handle or pointer to the actual location. Selecting a LOB returns the LOB locator instead of the LOB value. [Example 6-4](#) selects the LOB locator for b\_lob and places it a PL/SQL local variable named image1.

When you use an API function to manipulate the LOB value, you refer to the LOB using the locator. The PL/SQL DBMS\_LOB package contains useful routines to manipulate LOBs, such as PUT\_LINE() and GETLENGTH(), as in [Example 6-5](#).

In the OCI, LOB locators are mapped to LOBLocatorPointers, such as OCILobLocator \*.

For a BFILE, the LOB column has its own distinct locator, which refers to the LOB's value that is stored in an external file in the server's file system. This implies that two rows in

a table with a `BFILE` column may refer to the same file or two distinct files. A `BFILE` locator variable in a PL/SQL or OCI program behaves like any other automatic variable. With respect to file operations, it behaves like a file descriptor available as part of the standard I/O library of most conventional programming languages.

#### See Also:

- *Oracle Database SecureFiles and Large Objects Developer's Guide*
- *Oracle Database SecureFiles and Large Objects Developer's Guide for DBMS\_LOB API*

## 6.3.1 Selecting a LOBs and Assigning it to a Local Variable

### Example 6-4 Selecting a LOB Locator and Assigning it to a Local Variable

```
DECLARE
    image1 BLOB;
    image_no INTEGER := 101;
BEGIN
    SELECT b_lob INTO image1 FROM lob_table
           WHERE key_value = image_no;
           ...
END;
```

## 6.3.2 Manipulating LOBs

### Example 6-5 Manipulating LOBs with PUT\_LINE() and GETLENGTH()

```
BEGIN
    DBMS_OUTPUT.PUT_LINE('Size of the Image is: ',
                          DBMS_LOB.GETLENGTH(image1));
END;
```

## 6.4 Emptying LOBs

Use the special functions `EMPTY_BLOB` and `EMPTY_CLOB` in `INSERT` or `UPDATE` statements of SQL DML to initialize a `NULL` or `non-NULL` internal LOB to empty. These are available as special functions in Oracle SQL DML, and are not part of the `DBMS_LOB` package.

Before writing data to an internal LOB using OCI or the `DBMS_LOB` package, the LOB column must be made non-null; it must contain a locator that points to an empty or populated LOB value. You can initialize a `BLOB` column's value to empty by using the function `EMPTY_BLOB` in the `VALUES` clause of an `INSERT` statement. Similarly, a `CLOB` or `NCLOB` column's value can be initialized by using the function `EMPTY_CLOB`. Here is the syntax of these functions:

```
FUNCTION EMPTY_BLOB() RETURN BLOB;
FUNCTION EMPTY_CLOB() RETURN CLOB;
```

`EMPTY_BLOB` returns an empty locator of type `BLOB` and `EMPTY_CLOB` returns an empty locator of type `CLOB`, which can also be used for `NCLOBs`. The functions don't have an associated pragma.

An exception is raised if you use these functions anywhere but in the `VALUES` clause of a SQL `INSERT` statement or as the source of the `SET` clause in a SQL `UPDATE` statement.

[Example 6-6](#) shows `EMPTY_BLOB()` used with SQL DML.

[Example 6-7](#) shows how to use `EMPTY_CLOB()` in PL/SQL programs.

## 6.4.1 Using `EMPTY_BLOB()` in SQL

### Example 6-6 Using `EMPTY_BLOB()` with SQL DML

```
INSERT INTO lob_table VALUES (1001, EMPTY_BLOB(), 'abcde', NULL);
UPDATE lob_table SET c_lob = EMPTY_CLOB() WHERE key_value = 1001;
INSERT INTO lob_table VALUES (1002, NULL, NULL, NULL);
```

## 6.4.2 Using `EMPTY_CLOB()` in PL/SQL

### Example 6-7 Using `EMPTY_CLOB()` in PL/SQL Programs

```
DECLARE
  lobb          CLOB;
  read_offset  INTEGER;
  read_amount  INTEGER;
  rawbuf       RAW(20);
  charbuf      VARCHAR2(20);
BEGIN
  read_amount := 10; read_offset := 1;
  UPDATE lob_table SET c_lob = EMPTY_CLOB()
  WHERE key_value = 1002 RETURNING c_lob INTO lobb;
  dbms_lob.read(lobb, read_amount, read_offset, charbuf);
  dbms_output.put_line('lobb value: ' || charbuf);
END
```

## 6.5 Using the OCI to Manipulate LOBs

The OCI includes functions that enable access to data stored in `BLOBS`, `CLOBs`, `NCLOBs`, and `BFILES`. These functions are introduced in [Table 6-1](#).

[Table 6-2](#) compares the OCI and PL/SQL (`DBMS_LOB` package) interfaces in terms of LOB access.

[Example 6-8](#) shows how to select a LOB from the database into a locator. It assumes that the type `lob_type` has two attributes, `id` of type `INTEGER` and `data` of type `CLOB`, and that a table, `lob_table`, of type `lob_type`, exists.

A sample program, `populate.c`, uses the OCI to populate a `CLOB` with the contents of a file.

#### See Also:

*Oracle Call Interface Programmer's Guide* for detailed documentation, including parameters, parameter types, return values, and example code.

## 6.5.1 OCI Functions for Manipulating LOBs

**Table 6-1 Summary of OCI Functions for Manipulating LOBs**

Function	Description
<code>OCILobAppend()</code>	Appends LOB value to another LOB.
<code>OCILobArrayRead()</code>	Reads LOB data for multiple locators in one round-trip.
<code>OCILobArrayWrite()</code>	Writes LOB data for multiple locators in one round-trip.
<code>OCILobAssign()</code>	Assigns one LOB locator to another.
<code>OCILobCharSetForm()</code>	Returns the character set form of a LOB.
<code>OCILobCharSetId()</code>	Returns the character set ID of a LOB.
<code>OCILobClose()</code>	Closes a previously opened LOB or BFILE.
<code>OCILobCopy2()</code>	Copies all or a portion of a LOB into another LOB; replaces the deprecated method <code>OCILobCopy()</code> .
<code>OCILobCreateTemporary()</code>	Creates a temporary LOB.
<code>OCILobDisableBuffering()</code>	Disables the buffering subsystem use.
<code>OCILobEnableBuffering()</code>	Uses the LOB buffering subsystem for subsequent read and write operations of LOB data.
<code>OCILobErase2()</code>	Erases all or part of a LOB, starting at a specified offset; replaces the deprecated method <code>OCILobErase()</code> .
<code>OCILobFileClose()</code>	Closes an open BFILE.
<code>OCILobFileCloseAll()</code>	Closes all open BFILES.
<code>OCILobFileExists()</code>	Determines if a BFILE exists.
<code>OCILobFileName()</code>	Returns the name of a BFILE.
<code>OCILobFileIsOpen()</code>	Determines if the BFILE is open.
<code>OCILobFileOpen()</code>	Opens a BFILE.
<code>OCILobFileNameSet()</code>	Sets the name of a BFILE in a locator.
<code>OCILobFlushBuffer()</code>	Flushes changes made to the LOB buffering subsystem to the database (server)
<code>OCILobFreeTemporary()</code>	Frees a temporary LOB.
<code>OCILobGetChunkSize()</code>	Gets the chunk size of a LOB.
<code>OCILobGetContentType()</code>	Gets the user-specified content type string for the data in a SecureFile, if set.
<code>OCILobGetLength2()</code>	Gets the length of a LOB; replaced the deprecated method <code>OCILobGetLength()</code> .
<code>OCILobGetOptions()</code>	Gets the enabled settings that correspond to the specified input option types for a specified SecureFile LOB.
<code>OCILobGetStorageLimit()</code>	Gets the maximum length of a LOB (BLOB, CLOB, or NCLOB), in bytes.
<code>OCILobIsEqual()</code>	Determines if two LOB locators refer to the same LOB.
<code>OCILobIsOpen()</code>	Determines if a LOB or BFILE is open.
<code>OCILobIsTemporary()</code>	Determines if a locator points to a temporary LOB.

**Table 6-1 (Cont.) Summary of OCI Functions for Manipulating LOBs**

Function	Description
OCILOBLoadFromFile2()	Loads BFILE data into an internal LOB; replaced the deprecated method OCILOBLoadFromFile().
OCILOBLocatorAssign()	Assigns one LOB or BFILE locator to another.
OCILOBLocatorIsInit()	Tests to see if a LOB locator is initialized.
OCILOBOpen()	Opens a LOB in the specified mode.
OCILOBRead2()	Reads a specified portion of a non-null LOB or a BFILE into a buffer; replaces the deprecated method OCILOBRead().
OCILOBSetContentType()	Sets a content type string for the data in the SecureFile LOB.
OCILOBSetOptions()	Enables option settings for a SecureFile LOB.
OCILOBTrim2()	Truncates a LOB; replaces the deprecated method OCILOBTrim().
OCILOBWrite2()	Writes data from a buffer into a LOB, writing over existing data; replaces the deprecated method OCILOBWrite().
OCILOBWriteAppend2()	Writes data starting at the current end of a LOB; replaces the deprecated method OCILOBWriteAppend().

## 6.5.2 Comparing OCI and PL/SQL Interfaces

**Table 6-2 OCI and PL/SQL (DBMS\_LOB) Interfaces Compared**

OCI (oci.h)	PL/SQL DBMS_LOB (dbmslob.sql)
N/A	DBMS_LOB.COMPARE()
N/A	DBMS_LOB.INSTR()
N/A	DBMS_LOB.SUBSTR()
OCILOBAppend()	DBMS_LOB.APPEND()
OCILOBAssign()	N/A [use PL/SQL assign operator]
OCILOBCharSetForm()	N/A
OCILOBCharSetId()	N/A
OCILOBCopy()	DBMS_LOB.COPY()

**Table 6-2 (Cont.) OCI and PL/SQL (DBMS\_LOB) Interfaces Compared**

OCI (ociap.h)	PL/SQL DBMS_LOB (dbmslob.sql)
OCILobDisableBuffering()	N/A
OCILobEnableBuffering()	N/A
OCILobErase()	DBMS_LOB.ERASE()
OCILobFileClose()	DBMS_LOB.FILECLOSE()
OCILobFileCloseAll()	DBMS_LOB.FILECLOSEALL()
OCILobFileExists()	DBMS_LOB.FILEEXISTS()
OCILobFileGetName()	DBMS_LOB.FILEGETNAME()
OCILobFileIsOpen()	DBMS_LOB.FILEISOPEN()
OCILobFileOpen()	DBMS_LOB.FILEOPEN()
OCILobFileSetName()	N/A (use BFILENAME operator)
OCILobFlushBuffer()	N/A
OCILobGetLength()	DBMS_LOB.GETLENGTH()
OCILobIsEqual()	N/A
OCILobLocatorIsInit()	N/A [always initialize]
OCILobRead()	DBMS_LOB.READ()
OCILobTrim()	DBMS_LOB.TRIM()
OCILobWrite()	DBMS_LOB.WRITE()

### 6.5.3 Selecting a Stored LOB into a Locator

#### Example 6-8 Selecting a LOB from the Database into a Locator

```

/*-----*/
/* Select lob locators from a CLOB column          */
/* Use the 'FOR UPDATE' clause for writing to the LOBs. */
/*-----*/
static OCIEnv      *envhp;

```

```

static OCIServer      *srvhp;
static OCISvcCtx      *svchp;
static OCIError       *errhp;
static OCISession     *authp;
static OCIStmt        *stmthp;
static OCIDefine      *defnpl;
static OCIBind        *bndhp;

sb4 select_locator(int rowind)
{
    sword retval;
    boolean flag;
    int colc = rowind;
    OCILobLocator *clob;
    text *sqlstmt = (text *)"SELECT DATA FROM LOB_TABLE WHERE ID = :1 FOR UPDATE";

    if (OCIStmtPrepare(stmthp, errhp, sqlstmt, (ub4) strlen((char *)sqlstmt),
        (ub4) OCI_NTV_SYNTAX, (ub4) OCI_DEFAULT))
    {
        (void) printf("FAILED: OCIStmtPrepare() sqlstmt\n");
        return OCI_ERROR;
    }

    if (OCIStmtBindByPos(stmthp, bndhp, errhp, (ub4) 1, (dvoid *) &colc,
        (sb4) sizeof(colc), SQLT_INT, (dvoid *) 0, (ub2 *)0, (ub2 *)0, (ub4) 0,
        (ub4 *) 0, (ub4) OCI_DEFAULT))
    {
        (void) printf("FAILED: OCIStmtBindByPos()\n");
        return OCI_ERROR;
    }

    if (OCIDefineByPos(stmthp, &defnpl, errhp, (ub4) 1, (dvoid *) &clob, (sb4) -1,
        (ub2) SQLT_CLOB, (dvoid *) 0, (ub2 *) 0, (ub2 *) 0, (ub4) OCI_DEFAULT))
    {
        (void) printf("FAILED: OCIDefineByPos()\n");
        return OCI_ERROR;
    }

    /* Execute the select and fetch one row */
    if (OCIStmtExecute(svchp, stmthp, errhp, (ub4) 1, (ub4) 0,
        (CONST OCISnapshot*) 0, (OCISnapshot*) 0, (ub4) OCI_DEFAULT))
    {
        (void) printf("FAILED: OCIStmtExecute() sqlstmt\n");
        report_error();
        return OCI_ERROR;
    }

    /* Now test to see if the LOB locator is initialized */
    retval = OCILobLocatorIsInit(envhp, errhp, clob, &flag);
    if ((retval != OCI_SUCCESS) && (retval != OCI_SUCCESS_WITH_INFO))
    {
        (void) printf("Select_Locator --ERROR: OCILobLocatorIsInit(),
            retval = %d\n", retval);
        report_error();
        checkerr(errhp, retval);
        return OCI_ERROR;
    }

    if (!flag)
    {
        (void) printf("Select_Locator --ERROR: LOB Locator is not initialized.\n");
    }
}

```

```

        return OCI_ERROR;
    }

    return OCI_SUCCESS;
}

```

## 6.6 Using DBMS\_LOB Package to Manipulate LOBs

The `DBMS_LOB` package can be used to manipulate LOBs from PL/SQL. [Table 6-3](#) introduces its routines.

[Example 6-9](#) calls the `TRIM` procedure to trim a `CLOB` value to a smaller length. It assumes that the type `lob_type` has two attributes, `id` of type `INTEGER` and `data` of type `CLOB`, and that a table, `lob_table`, of type `lob_type`, exists. Because this example deals with `CLOB` data, the second argument to `DBMS_LOB.TRIM`, the literal `834004`, specifies the number of characters. If the example dealt with `BLOB` data, this argument would be interpreted as a number of bytes.

### See Also:

*Oracle Database PL/SQL Packages and Types Reference* provides full details on using the routines of the `DBMS_LOB` package.

### 6.6.1 DBMS\_LOB Package Routines

**Table 6-3 Summary of DBMS\_LOB Package Routines**

Routine	Description
<code>APPEND()</code>	Appends the contents of the source LOB to the destination LOB.
<code>COPY()</code>	Copies all or part of the source LOB to the destination LOB.
<code>ERASE()</code>	Erases all or part of a LOB.
<code>LOADBLOBFROMFILE()</code>	Loads <code>BFILE</code> data into an internal <code>BLOB</code> .
<code>LOADCLOBFROMFILE()</code>	Loads <code>BFILE</code> data into an internal <code>CLOB</code> .
<code>TRIM()</code>	Trims the LOB value to the specified shorter length.
<code>WRITE()</code>	Write data to the LOB from a specified offsets
<code>GETLENGTH</code>	Gets the length of the LOB value.
<code>INSTR()</code>	Return the matching position of the $n^{\text{th}}$ occurrence of the pattern in the LOB.



**Table 6-3 (Cont.) Summary of DBMS\_LOB Package Routines**

Routine	Description
READ()	Reads data from the LOB starting at the specified offset
SUBSTR()	Returns part of the LOB value starting at the specified offset.
FILECLOSE()	Closes the file.
FILECLOSEALL()	Closes all previously opened files.
FILEEXISTS()	Tests if the file exists on the server.
FILEGETNAME()	Gets the directory alias and file name.
FILEISOPEN()	Tests the file was opened using the input BFILE locators.
FILEOPEN()	Opens a file.

## 6.6.2 Trimming a CLOB

### Example 6-9 Trimming a CLOB

```

PROCEDURE Trim_Clob IS
    clob_loc CLOB;
BEGIN
    -- get the LOB Locator
    SELECT data into clob_loc FROM lob_table
    WHERE id = 179 FOR UPDATE;
    -- call the TRIM Routine
    DBMS_LOB.TRIM(clob_loc, 834004);
    COMMIT;
END;

```

## 6.7 LOBs in External Procedures

LOB locators can be passed as arguments to an external procedure, as defined in [Example 6-1](#).

The corresponding C function gets an argument of type `OCIlobLocator *`. When the function defined in [Example 6-10](#) is called, it invokes a C routine, `c_findmin()`, with the signature `int c_findmin(OCIlobLocator*)`.

The routine `c_findmin` is in a shared library associated with `DS_Lib`. To use the pointer `OCIlobLocator*` to get data from the LOB, you must reconnect to the database by making a callback.

## 6.7.1 Defining an External Procedure (PL/SQL)

### Example 6-10 Defining a PL/SQL External Procedure

```
FUNCTION DS_Findmin(data CLOB) RETURN PLS_INTEGER IS EXTERNAL  
    NAME "c_findmin" LIBRARY DS_Lib LANGUAGE C;
```

## 6.8 LOBs and Triggers

You cannot write to a LOB (:old or :new value) in any kind of trigger.

In regular triggers, you can read the :old value, but you cannot read the :new value. In INSTEAD OF triggers, you can read both the :old and the :new values.

You cannot specify LOB type columns in an OF clause, because BFILE types can be updated without updating the underlying table on which the trigger is defined.

Using OCI functions or the DBMS\_LOB package to update LOB values or LOB attributes of object columns does not fire triggers defined on the table that contains the columns or attributes.

## 6.9 Using Open/Close as Bracketing Operations for Efficient Performance

The `Open/Close` functions let you indicate the beginning and end of a series of LOB operations, so that large-scale operations, such as updating indexes, can be performed when the `Close` function is called. This means that when the `Open` call is made, the index would not be updated each time the LOB is modified, and that such updating would not resume until the `Close` call.

You do not have to wrap all LOB operations inside the `Open/Close` operations, but code block can be very valuable for the following reasons:

- If you do not wrap LOB operations inside an `Open/Close` call, then each modification to the LOB implicitly opens and closes the LOB, thereby firing all triggers. If you do wrap the LOB operations inside a pair of `Open...Close` operations, then the triggers are not fired for each LOB modification. Instead, one trigger is fired when the `Close` call is made. Likewise, extensible indexes are not updated until the `Close` call. This means that any extensible indexes on the LOB are not valid between the `Open...Close` calls.
- You must apply this technology carefully because state, which reflects the changes to the LOB, is not saved between the `Open` and the `Close` operations. When you have called `Open`, Oracle no longer keeps track of what portions of the LOB value were modified, nor of the old and new values of the LOB that result from any modifications. The LOB value is still updated directly for each `OCILob*` or `DBMS_LOB` operation, and the usual read consistency mechanism is still in place. You may also want extensible indexes on the LOB to be updated, as LOB modifications are made because the extensible LOB indexes are always valid and may be used at any time.
- The API enables you to determine if the LOB is open. In all cases, openness is associated with the LOB, not the locator. The locator does not save any state information.

## 6.9.1 Errors and Restrictions Regarding Open/Close Operations

It is an error to commit the transaction before closing all previously opened LOBs. At transaction rollback time, all LOBs that are still open are discarded, which means that they are not closed, which fires the triggers.

It is an error to `Open/Close` the same LOB twice, either with different locators or with the same locator. It is an error to close a LOB that has not been opened.

**Example 6-11** assumes that `loc1` refers to an open LOB, and is assigned to `loc2`. If `loc2` is subsequently used to modify the LOB value, the modification is grouped with `loc1`'s modifications. This means that there is only one entry in the LOB manager's state, not one for each locator. When the LOB is closed, either through `loc1` or `loc2`, the triggers are fired, so all updates made to the LOB through either locator are committed. After the close of the LOB, if the user tries to use either locator to modify the LOB, the operation performs an implicit `Open()` and `Close()`, as `Open() ... operation ... Close()`. Note that consistent read is still maintained for each locator. Remember that it is the LOB, not the locator, that is opened and closed. No matter how many copies of the locator are made, the triggers for the LOB are fired only one time on the first `Close()` call.

### 6.9.1.1 Working with Open() and Close() Code Blocks

#### **Example 6-11 Using Open() and Close() Code Block**

```
open (loc1);
loc2 := loc1;
write (loc1);
write (loc2);
open (loc2); /* error because the LOB is open */
close (loc1); /* triggers are fired and all LOB updates made before this
              statement by any locator are incorporated in the extensible
              index */
write (loc2); /* implicit open, write, implicit close */
```

# 7

## Using Extensible Indexing

Extensible indexing allows you to implement modes of indexing in addition to those that are built into Oracle. Consider when you should create **domain indexes**, which are indexes created using the extensible indexing framework.

### 7.1 Overview of Extensible Indexing

Consider some terms and methods for building indexes; this material may be familiar to developers who worked on database applications previously.

#### 7.1.1 Purpose of Indexes

With large amounts of data such as that in databases, indexes make locating and retrieving the data faster and more efficient. Whether they refer to records in a database or text in a technical manual, entries in an index indicate three things about the items they refer to:

- What the item is ("employee information on Mary Lee" or "the definition of extensible indexing")
- Where the item is ("record number 1000" or "page 100")
- How the item is stored ("in a consecutive series of records" or "as text on a page")

Most sets of data can be indexed in several different ways. To provide the most useful and efficient access to data, it is often critical to choose the right style of indexing. This is because no indexing method is optimal for every application.

Database applications normally retrieve data with queries, which often use indexes in selecting subsets of the available data. Queries can differ radically in the operators used to express them, and thus in the methods of indexing that provide the best access.

- To learn which sales people work in the San Francisco office, you need an operator that checks for equality. Hash structures handle equality operators very efficiently.
- To learn which sales people earn more than  $x$  but less than  $y$ , you need an operator that checks ranges. B-tree structures are better at handling range-oriented queries.

#### 7.1.2 Purpose of Extensible Indexing

Databases are constantly incorporating new types of information that are more complex and more specific to certain tasks, such as medical or multimedia applications. As a result, queries are becoming more complex, and the amount of data they must scan continues to grow. Oracle provides the extensible indexing framework so you can tailor your indexing methods to your data and your applications, thus improving performance and ease of use.

With extensible indexing, your application

- Defines the structure of the index
- Stores the index data, either inside the Oracle database (for example, in the form of index-organized tables) or outside the Oracle database
- Manages, retrieves, and uses the index data to evaluate user queries

Thus, your application controls the structure and semantic content of the index. The database system cooperates with your application to build, maintain, and employ the domain index. As a result, you can create indexes to perform tasks that are specific to the domain in which you work, and your users compose normal-looking queries using operators you define.

## 7.1.3 When to Use Extensible Indexing

Oracle's built-in indexing facilities are appropriate to a large number of situations. However, as data becomes more complex and applications are tailored to specific domains, situations arise that require other approaches. For example, extensible indexing can help you solve problems like these:

- Implementing new search operators using specialized index structures  
You can define operators to perform specialized searches using your index structures.
- Indexing unstructured data  
The built-in facilities cannot index a column that contains LOB values.
- Indexing attributes of column objects  
The built-in facilities cannot index column objects or the elements of a collection type.
- Indexing values derived from domain-specific operations

Oracle object types can be compared with map functions or order functions. If the object uses a map function, then you can define a function-based index for use in evaluating relational predicates. However, this only works for predicates with parameters of finite range; it must be possible to precompute function values for all rows. In addition, you cannot use order functions to construct an index.

## 7.1.4 Index Structures

Consider some frequently-used index structures that illustrate the choices available to designers of domain indexes.

### 7.1.4.1 B-tree

No index structure can satisfy all needs, but the self-balancing B-tree index comes closest to optimizing the performance of searches on large sets of data. Each B-tree node holds multiple keys and pointers. The maximum number of keys in a node supported by a specific B-tree is the order of that tree. Each node has a potential of order+1 pointers to the level below it. For example, the order=2 B-tree illustrated in [Figure 7-1](#) has tree pointers: to child nodes whose value is less than the first key, to the child nodes whose value is greater than the first key and less than the second key, and to the child nodes whose value is greater than the second key. Thus, the B-tree algorithm minimizes the number of reads and writes necessary to locate a record by

passing through fewer nodes than in a binary tree algorithm, which has only one key and at most two children for each decision node. Here we describe the **Knuth** variation in which the index consists of two parts: a sequence set that provides fast sequential access to the data, and an index set that provides direct access to the sequence set.

Although the nodes of a B-tree generally do not contain the same number of data values, and they usually contain a certain amount of unused space, the B-tree algorithm ensures that the tree remains balanced and that the leaf nodes are at the same level.

**Figure 7-1 B-tree Index Structure**

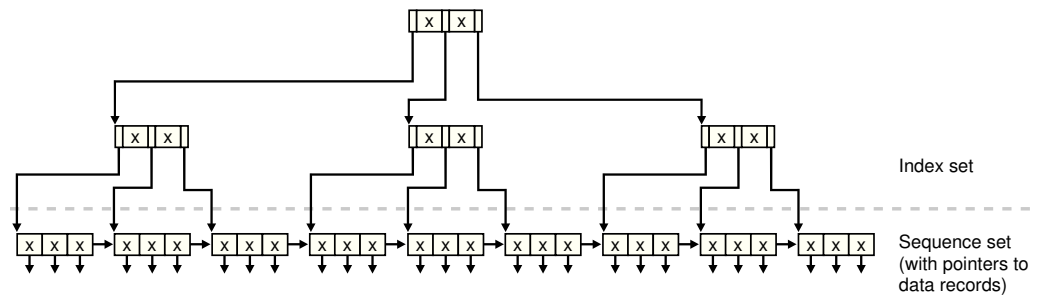

### 7.1.4.2 Hash

Hashing gives fast direct access to a specific stored record based on a given field value. Each record is placed at a location whose address is computed as some function of some field of that record. The same function is used to insert and retrieve.

The problem with hashing is that the physical ordering of records has little if any relation to their logical ordering. Also, there can be large unused areas on the disk.

**Figure 7-2 Hash Index Structure**

0	1	2
	S300 Blake 30 Paris	
3	4	5
		S200 Jones 10 Paris
6	7	8
S500 Adams 30 Athens		
9	10	11
S100 Smith 30 London	S400 Clark 20 London	
12		

### 7.1.4.3 k-d tree

Data that has two dimensions, such as latitude and longitude, can be stored and retrieved efficiently using a variation on the k-d tree known as the 2-d tree.

In this structure, each node is a data type with fields for information, the two co-ordinates, and a left-link and right-link, which can point to two children.

**Figure 7-3 2-d Index Structure**

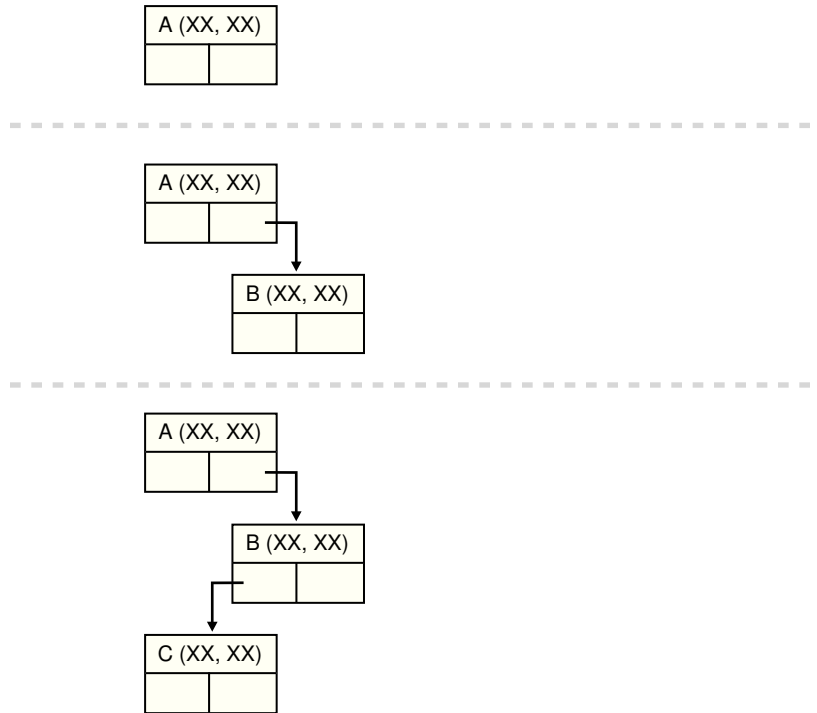

This structure is good at range queries. That is, if the user specifies a point (xx, xx) and a distance, the query returns the set of all points within the specified distance of the original point.

2-d trees are easy to implement. However, because a 2-d tree containing  $k$  nodes can have a height of  $k$ , insertion and querying can be complex.

### 7.1.4.4 Point Quadtree

The point quadtree, in [Figure 7-4](#), is also used to represent point data in a two dimensional spaces, but these structures divide regions into four parts where 2-d trees divide regions into two. The fields of the record type for this node comprise an attribute for information, two co-ordinates, and four compass points (such as NW, SW, NE, SE) that can point to four children.

Figure 7-4 Point Quadtree Index Structure

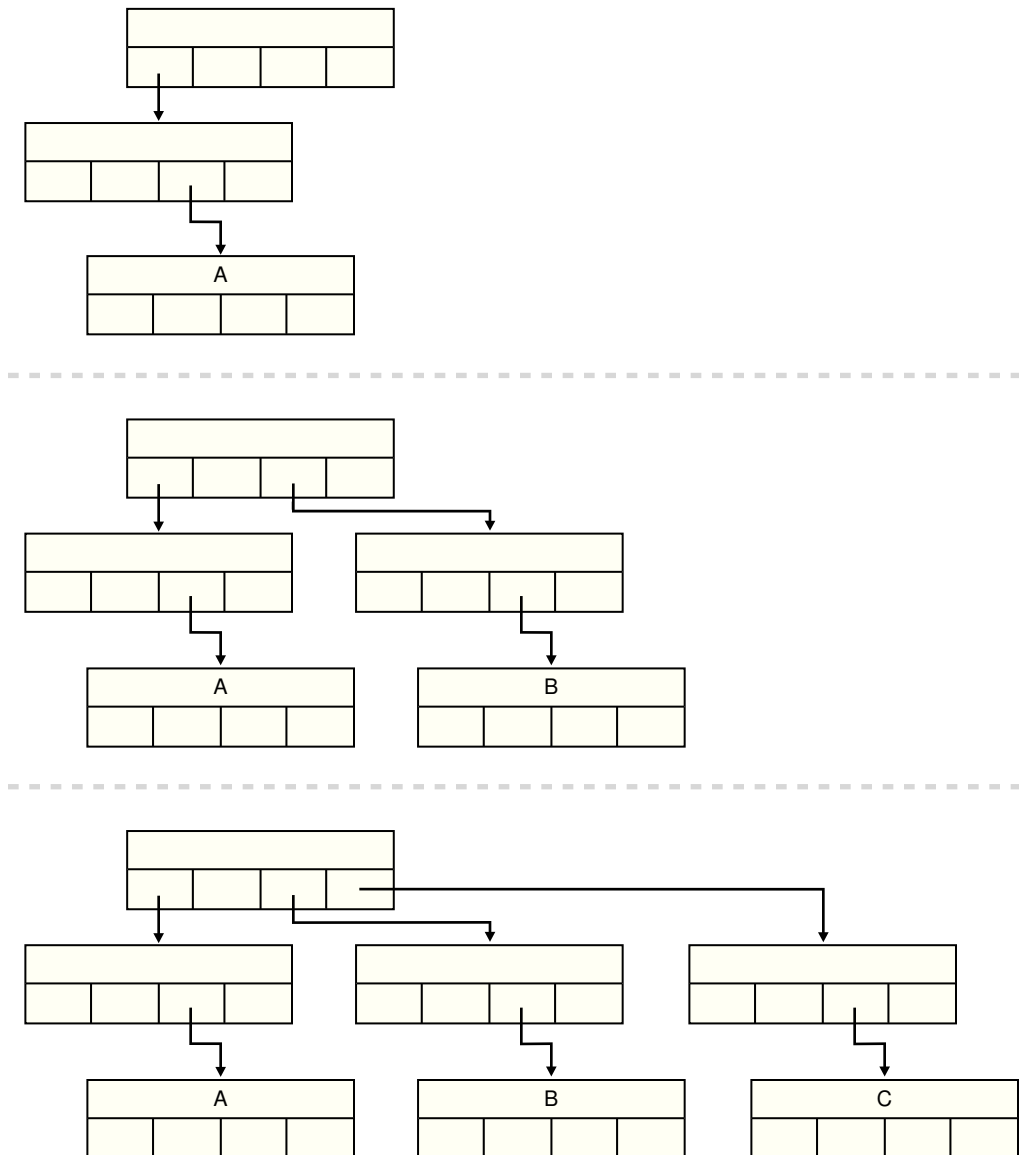

Like 2-d trees, point quadtrees are easy to implement. However, a point quadtree containing  $k$  nodes can have a height of  $k$ , so insertion and querying can be complex. Each comparison requires comparisons on at least two co-ordinates. In practice, though, the lengths from root to leaf tend to be shorter in point quadtrees.

## 7.2 Extensible Indexing Framework

The extensible indexing framework is a SQL-based interface that lets you define domain-specific operators and indexing schemes, and integrate these into the Oracle server.

The extensible indexing framework consists of the following components:

- **Indextypes:** An indextype schema object specifies the routines that manage definition, maintenance, and scan operations for application-specific indexes. An



indextype tells the Oracle server how to establish a user-defined index on a column of a table or attribute of an object.

- **Domain Indexes:** An application-specific index created using an indextype is called a domain index because it indexes data in application-specific domains. A domain index is an instance of an index that is created, managed, and accessed by the routines specified by an indextype.
- **Operators:** Queries and data manipulation statements can use application-specific operators, such as the `Overlaps` operator in the spatial domain. User-defined operators are bound to functions. They can also be evaluated using indexes. For instance, the equality operator can be evaluated using a hash index. An indextype provides an index-based implementation for the operators it defines.
- **Index-Organized Tables:** With index-organized tables, your application can define, build, maintain, and access indexes for complex objects using a table metaphor. To the application, an index is modeled as a table, where each row is an index entry. Index-organized tables handle duplicate index entries, which can be important with complex types of data.

The extensible indexing framework lets you perform the following actions:

- Encapsulate application-specific index management routines as an indextype schema object.
- Define a domain index on table columns.
- Process application-specific operators efficiently.

With the extensible indexing framework, you can build a domain index that operates much like any other Oracle index. Users write standard queries using operators you define. To create, drop, truncate, modify, and search a domain index, the Oracle server invokes the application code you specify as part of the indextype.

#### See Also:

- [Defining Operators](#) for detailed information on user-defined operators
- *Oracle Database Administrator's Guide* for detailed information on index-organized tables

## 7.3 Using the Text Indextype

Consider an extensible indexing framework with a skeletal example that both defines a new text indexing scheme using the `Text` indextype, and uses the `Text` indextype to index and operate on textual data.

### 7.3.1 Defining the Indextype

The order in which you create the components of an indextype depends on whether or not you are creating an index-based functional implementation.

#### 7.3.1.1 Non-Index-Based Functional Implementations

To define the `Text` indextype, the indextype designer must follow these steps:

**1. Define and code the functional implementation for the supported operator**

The `Text` indextype supports an operator called `Contains`, which accepts a text value and a key, and returns a number indicating whether the text contains the key. The functional implementation of this operator is a regular function defined as:

```
CREATE FUNCTION TextContains(Text IN VARCHAR2, Key IN VARCHAR2)
RETURN NUMBER AS
BEGIN
    .....
END TextContains;
```

**2. Create the new operator and bind it to the functional implementation**

```
CREATE OPERATOR Contains
    BINDING (VARCHAR2, VARCHAR2) RETURN NUMBER USING TextContains;
```

**3. Define a type that implements the index interface `ODCIIndex`**

This involves implementing routines for index definition, index maintenance, and index scan operations. Oracle calls:

- The index definition routines `ODCIIndexCreate()`, `ODCIIndexAlter()`, and `ODCIIndexDrop()` to perform the appropriate operations when the index is created, altered, or dropped, or the base table is truncated
- The index maintenance routines `ODCIIndexInsert()`, `ODCIIndexDelete()`, and `ODCIIndexUpdate()` to maintain the text index when table rows are inserted, deleted, or updated
- The index scan routines `ODCIIndexStart()`, `ODCIIndexFetch()`, and `ODCIIndexClose()` to scan the text index and retrieve rows of the base table that satisfy the operator predicate

```
CREATE TYPE TextIndexMethods
(
    STATIC FUNCTION ODCIIndexCreate(...)
    ...
);
CREATE TYPE BODY TextIndexMethods
(
    ...
);
```

**4. Create the `Text` indextype schema object**

The indextype definition specifies the operators supported by the new indextype and the type that implements the index interface.

```
CREATE INDEXTYPE TextIndexType
FOR Contains(VARCHAR2, VARCHAR2)
USING TextIndexMethods
WITH SYSTEM MANAGED STORAGE TABLES;
```

### 7.3.1.2 Index-Based Functional Implementations

If you are creating an index-based functional implementation, you perform the same operations as for non-index-based functional implementations, but in a different order. This order is required because definition of an index-based functional implementation requires the implementation type as a parameter.

1. Define the implementation type
2. Define and code the functional implementation

3. Create the operator
4. Create the indextype

## 7.3.2 Using the Indextype

When the `Text` indextype has been successfully defined, users can define text indexes on text columns and use the `Contains` operator to query text data.

Suppose the `MyEmployees` table is defined by the statement in [Example 7-1](#).

To build a text domain index on the `resume` column, a user issues the statement in [Example 7-2](#).

To query the text data in the `resume` column, users issue statements like the one in [Example 7-3](#). The query execution uses the text index on `resume` to evaluate the `Contains` predicate.

### 7.3.2.1 Declaring a New Table

#### Example 7-1 Declaring a New Table

```
CREATE TABLE MyEmployees
(employee_id NUMBER(6),
 first_name VARCHAR2(20),
 last_name VARCHAR2(25),
 salary NUMBER(8,2),
 resume VARCHAR2(2000),
 location VARCHAR2(200),
 department_id NUMBER(4));
```

### 7.3.2.2 Building a Text Domain Index for the Table

#### Example 7-2 Building a Text Domain Index

```
CREATE INDEX ResumeIndex ON MyEmployees(resume) INDEXTYPE IS TextIndexType;
```

### 7.3.2.3 Querying a Table Using a Contains() Operator

#### Example 7-3 Using the Contains() Operator

```
SELECT * FROM MyEmployees WHERE Contains(resume, 'Oracle') =1;
```

# 8

## Building Domain Indexes

Consider domain indexes and the `ODCIIndex` interface: how to use of domain indexes, their partitioning, applicable restrictions, and migration procedures.

If you use user-managed domain indexes, the information specific to their implementation is in [User-Managed Local Domain Indexes](#)

### 8.1 Overview of Indextypes and Domain Indexes

A **domain index** is an index designed for a specialized domain, such as spatial or image processing. Users can build a domain index of a given type after the designer creates the **indextype**. The behavior of domain indexes is specific to an industry, a business function, or some other special purpose; you must specify it during cartridge development.

The system-managed approach to domain indexes, new in the Oracle Database 11g Release 1, requires less programmatic overhead and delivers better performance than the earlier user-managed domain indexes. It addresses the limitations of the user-managed approach, and has the following benefits:

- Because the kernel performs many more maintenance tasks on behalf of the user, there is no need for programmatic support for table and partition maintenance operations. These operations are implemented by taking actions in the server, thus requiring a very minimal set of user-defined interface routines to be coded by the user. The cartridge code can then be relatively unaware of partition issues.
- The number of objects that must be managed to support local partitioned domain indexes is identical to those for non-partitioned domain indexes. For local partitioned indexes, the domain index storage tables are equipartitioned with respect to the base tables (using system-partitioned tables); therefore, the number of domain index storage tables does not increase with an increase in the number of partitions.
- A single set of query and DML statements can now access and manipulate the system-partitioned storage tables, facilitating cursor sharing and enhancing performance.

Oracle recommends that you develop new applications with system-managed domain indexes instead of user-managed domain indexes.

Indextypes encapsulate search and retrieval methods for complex domains such as text, spatial, and image processing. An indextype is similar to the indexes that are supplied with the Oracle Database. The difference is that you provide the application software that implements the indextype.

An indextype has two major components:

- The methods that implement the behavior of the indextype, such as creating and scanning the index
- The operators that the indextype supports, such as `Contains()` or `Overlaps()`

To create an indextype, you must perform the following steps:

- Define the supported operators and create the functions that implement them
- Create the methods that implement the `ODCIIndex` interface, and define the type that encapsulates them, called the **implementation type**
- Create the indextype, specifying the implementation type and listing the operators with their bindings

In this context:

- Interface means a logical set of documented method specifications (not a separate schema object)
- `ODCIIndex` interface means a set of index definition, maintenance, and scan routine specifications



**See Also:**

[Defining Operators](#)

## 8.2 ODCIIndex Interface

The `ODCIIndex` interface specifies all the routines you must supply to implement an indextype. The routines must be implemented as type methods.

The `ODCIIndex` interface comprises the following method classes:

- Index definition methods
- Index maintenance methods
- Index scan methods
- Index metadata method



**See Also:**

[Extensible Indexing Interface](#) for method signatures and parameter descriptions

### 8.2.1 Index Definition Methods

The application calls index definition methods when a user issues a `CREATE`, `ALTER`, `DROP`, or `TRUNCATE` statement on an index of indextype.

#### 8.2.1.1 ODCIIndexCreate()

When a user issues a `CREATE INDEX` statement that references the indextype, Oracle calls your `ODCIIndexCreate()` method, passing it any parameters specified as part of the `CREATE INDEX... PARAMETERS (...)` statement, plus the description of the index.

Typically, this method creates the tables or files in which you plan to store index data. Unless the base table is empty, the method should also build the index.

### 8.2.1.2 ODCIIndexAlter()

When a user issues an `ALTER INDEX` statement referencing your indextype, Oracle calls your `ODCIIndexAlter()` method, passing it the description of the domain index to be altered along with any specified parameters. This method is also called to handle an `ALTER INDEX` with the `REBUILD` or `RENAME` options. What your method must do depends on the nature of your domain index, so the details are left to you as the designer of the indextype.

### 8.2.1.3 ODCIIndexDrop()

When a user destroys an index of your indextype by issuing a `DROP INDEX` statement, Oracle calls your `ODCIIndexDrop()` method.

## 8.2.2 Index Maintenance Methods

Your index maintenance methods are called when users issue `INSERT`, `UPDATE`, and `DELETE` statements on tables with columns or object type attributes indexed by your indextype.

### 8.2.2.1 ODCIIndexInsert()

When a user inserts a record, Oracle calls your `ODCIIndexInsert()` method, passing it the new values in the indexed columns and the corresponding row identifier.

### 8.2.2.2 ODCIIndexDelete()

When a user deletes a record, Oracle calls your `ODCIIndexDelete()` method, passing it the old values in the indexed columns and the corresponding row identifier.

### 8.2.2.3 ODCIIndexUpdate()

When a user updates a record, Oracle calls your `ODCIIndexUpdate()` method, passing it the old and new values in the indexed columns and the corresponding row identifier.

## 8.2.3 Index Scan Methods

Your index scan methods specify the index-based implementation for evaluating predicates containing the operators supported by your indextype. Index scans involve methods for initialization, fetching rows or row identifiers, and cleaning up after all rows are returned.

There are two modes of evaluating the operator predicate and returning the resulting set of rows:

- **Precompute All:** Compute the entire result set in `ODCIIndexStart()`. Iterate over the results returning a batch of rows from each call to `ODCIIndexFetch()`. This mode is applicable to operators that must look at the entire result set to compute ranking, relevance, and so on for each candidate row. It is also possible to return one row at a time if your application requires that.

- **Incremental Computation:** Compute a batch of result rows in each call to `ODCIIndexFetch()`. This mode is applicable to operators that can determine the candidate rows one at a time without having to look at the entire result set. It is also possible to return one row at a time if your application requires that.

### 8.2.3.1 ODCIIndexStart()

Oracle calls your `ODCIIndexStart()` method at the beginning of an index scan, passing it information on the index and the operator. Typically, this method:

- Initializes data structures used in the scan
- Parses and executes SQL statements that query the tables storing the index data
- Saves any state information required by the fetch and cleanup methods, and returns the state or a handle to it
- Sometimes generates a set of result rows to be returned at the first invocation of `ODCIIndexFetch()`

The information on the index and the operator is not passed to the fetch and cleanup methods. Thus, `ODCIIndexStart()` must save **state** data that must be shared among the index scan routines and return it through an output `sctx` parameter. To share large amounts of state data, allocate cursor-duration memory and return a handle to the memory in the `sctx` parameter.

As member methods, `ODCIIndexFetch()` and `ODCIIndexClose()` are passed the built-in `SELF` parameter, through which they can access the state data.

#### See Also:

- [ODCIIndexClose\(\)](#)
- [ODCIIndexFetch\(\)](#)
- [ODCIIndexStart\(\)](#)
- *Oracle Call Interface Programmer's Guide* for information on memory services and maintaining context

### 8.2.3.2 ODCIIndexFetch()

Oracle calls your `ODCIIndexFetch()` method to return the row identifiers of the next batch of rows that satisfies the operator predicate, passing it the state data returned by `ODCIIndexStart()` or the previous `ODCIIndexFetch()` call. The operator predicate is specified in terms of the operator expression (name and arguments) and a lower and upper bound on the operator return values. Thus, `ODCIIndexFetch()` must return the row identifiers of the rows for which the operator return value falls within the specified bounds. To indicate the end of index scan, return a `NULL`.

 **See Also:**

- [ODCIIndexFetch\(\)](#)
- [ODCIIndexStart\(\)](#)

### 8.2.3.3 ODCIIndexClose()

Oracle calls your [ODCIIndexClose\(\)](#) method when the cursor is closed or reused, passing it the current state. [ODCIIndexClose\(\)](#) should perform whatever cleanup or closure operations your indextype requires.

### 8.2.4 Index Metadata Method

The [ODCIIndexGetMetadata\(\)](#) method is optional. If you implement it, the Export utility calls it to write implementation-specific metadata into the Export dump file. This metadata might be policy information, version information, individual user settings, and so on, which are not stored in the system catalogs. The metadata is written to the dump files as anonymous PL/SQL blocks that are executed at import time immediately before the creation of the associated index.

### 8.2.5 Transaction Semantics During Index Method Execution

The index interface methods (with the exception of the index definition methods, [ODCIIndexCreate\(\)](#), [ODCIIndexAlter\(\)](#), and [ODCIIndexDrop\(\)](#)) are invoked under the same transaction that triggered these actions. Thus, the changes made by these routines are atomic and are committed or aborted based on the parent transaction. To achieve this, there are certain restrictions on the nature of the actions that you can perform in the different indextype routines:

- Index definition routines have no restrictions.
- Index maintenance routines can only execute Data Manipulation Language statements. These DML statements cannot update the base table on which the domain index is created.
- Index scan routines can only execute SQL query statements.

For example, if an `INSERT` statement caused the [ODCIIndexInsert\(\)](#) routine to be invoked, [ODCIIndexInsert\(\)](#) runs under the same transaction as `INSERT`. The [ODCIIndexInsert\(\)](#) routine can execute any number of DML statements (for example, insert into index-organized tables). If the original transaction aborts, all the changes made by the indextype routines are rolled back.

However, if the indextype routines cause changes external to the database (like writing to external files), transaction semantics are not assured.



 **See Also:**

- [ODCIIndexAlter\(\)](#)
- [ODCIIndexCreate\(\)](#)
- [ODCIIndexDrop\(\)](#)
- [ODCIIndexInsert\(\)](#)

## 8.2.6 Transaction Semantics for Index Definition Routines

The index definition routines do not have any restrictions on the nature of actions within them. Consider `ODCIIndexCreate()` to understand this difference. A typical set of actions to be performed in `ODCIIndexCreate()` could be:

1. Create an index-organized table.
2. Insert data into the index-organized table.
3. Create a secondary index on a column of the index-organized table.

To allow `ODCIIndexCreate()` to execute an arbitrary sequence of DDL and DML statements, each statement is considered to be an independent operation. Consequently, the changes made by `ODCIIndexCreate()` are not guaranteed to be atomic. The same is true for other index-definition routines.

 **See Also:**

[ODCIIndexCreate\(\)](#)

## 8.2.7 Consistency Semantics during Index Method Execution

The index maintenance (and scan routines) execute with the same snapshot as the top level SQL statement performing the DML (or query) operation. This keeps the index data processed by the index method consistent with the data in the base tables.

## 8.2.8 Privileges During Index Method Execution

Indextype routines always execute as the owner of the index. To support this, the index access driver dynamically changes user mode to index owner before invoking the indextype routines.

For certain operations, indextype routines store information in tables owned by the indextype designer. The indextype implementation must perform those actions in a separate routine, which is executed using the definer's privileges.

 **See Also:**

*Oracle Database SQL Language Reference* for details on `CREATE TYPE`

## 8.3 Creating, Dropping, and Commenting Indextypes

Consider the SQL statements that manipulate indextypes.

 **See Also:**

*Oracle Database SQL Language Reference* for complete descriptions of these SQL statements

### 8.3.1 Creating Indextypes

When you have implemented the `ODCIIndex` interface and defined the implementation type, you can create a new indextype by specifying the list of operators supported by the indextype and referring to the type that implements the index interface. Using the information retrieval example, the DDL statement for defining the new indextype `TextIndexType`, which supports the `Contains` operator and whose implementation is provided by the type `TextIndexMethods`, as demonstrated by [Example 8-1](#).

In addition to the `ODCIIndex` interface routines, the implementation type must implement the `ODCIGetInterfaces()` routine. This routine returns the version of the interface implemented by the implementation type. Oracle invokes the `ODCIGetInterfaces()` routine when executing `CREATE INDEXTYPE`.

#### Example 8-1 Creating an Indextype

```
CREATE INDEXTYPE TextIndexType
FOR Contains (VARCHAR2, VARCHAR2)
USING TextIndexMethods
WITH SYSTEM MANAGED STORAGE TABLES;
```

### 8.3.2 Dropping Indextypes

To remove the definition of an indextype, use the `DROP` statement, as in [Example 8-2](#):

The default `DROP` behavior is `DROP RESTRICT` semantics, that is, if one or more domain indexes exist that uses the indextype then the `DROP` operation is disallowed. Users can override the default behavior with the `FORCE` option, which drops the indextype and marks any dependent domain indexes invalid.

 **See Also:**

["Object Dependencies\\_ Drop Semantics\\_ and Validation"](#) for details on object dependencies and drop semantics

**Example 8-2 Dropping an IndexType**

```
DROP INDEXTYPE TextIndexType;
```

### 8.3.3 Commenting IndexTypes

Use the `COMMENT` statement to supply information about an indextype or operator, as shown in [Example 8-3](#).

To place a comment on an indextype, the indextype must be in your own schema, or you must have the `COMMENT ANY INDEXTYPE` privilege.

**Example 8-3 Commenting an INDEXTYPE**

```
COMMENT ON INDEXTYPE
TextIndexType IS 'implemented by the type TextIndexMethods to support the Contains
operator';
```

#### 8.3.3.1 INDEXTYPE Comments

Comments on indextypes can be viewed in these data dictionary views:

- `ALL_INDEXTYPE_COMMENTS` displays comments for the user-defined indextypes accessible to the current user.
- `DBA_INDEXTYPE_COMMENTS` displays comments for all user-defined indextypes in the database.
- `USER_INDEXTYPE_COMMENTS` displays comments for the user-defined indextypes owned by the current user.

**Table 8-1 Views \*\_INDEXTYPE\_COMMENTS**

Column	Data Type	Required	Description
OWNER	VARCHAR2(30)	NOT NULL	Owner of the user-defined indextype
INDEXTYPE_NAME	VARCHAR2(30)	NOT NULL	Name of the user-defined indextype
COMMENT	VARCHAR2(4000)		Comment for the user-defined indextype

## 8.4 Domain Indexes

Consider domain index operations and how metadata associated with the domain index may be obtained.

### 8.4.1 Domain Index Operations

Consider how to create, alter, truncate, and drop domain indexes.

### 8.4.1.1 Creating a Domain Index

A domain index can be created on a column of a table, just like a B-tree index. However, an `indextype` must be explicitly specified. [Example 8-4](#) shows how to specify an `indextype` on the `MyEmployees` table that was declared in [Example 7-1](#).

The `INDEXTYPE` clause specifies the `indextype` to be used. The `PARAMETERS` clause identifies any parameters for the domain index, specified as a string. This string is passed uninterpreted to the `ODCIIndexCreate()` routine for creating the domain index. In the preceding example, the parameters string identifies the language of the text document (thus identifying the lexical analyzer to use) and the list of stop words which are to be ignored while creating the text index.

#### Example 8-4 Creating a Domain Index

```
CREATE INDEX ResumeTextIndex ON MyEmployees(resume)
INDEXTYPE IS TextIndexType
PARAMETERS (':Language English :Ignore the a an');
```

### 8.4.1.2 Changing a Domain Index

The parameter string is passed uninterpreted to `ODCIIndexAlter()` routine, which takes appropriate actions to alter the domain index. This example specifies an additional stop word to ignore in the text index.

#### Example 8-5 Changing a Domain Index

```
ALTER INDEX ResumeTextIndex PARAMETERS (':Ignore on');
```

### 8.4.1.3 Renaming a Domain Index

The `ALTER` statement can be used to rename a domain index, as shown in [Example 8-6](#).

A statement of this form causes Oracle to invoke the `ODCIIndexAlter()` method, which takes appropriate actions to rename the domain index.

#### Example 8-6 Renaming a Domain Index

```
ALTER INDEX ResumeTextIndex RENAME TO ResumeTIdx;
```

### 8.4.1.4 Rebuilding a Domain Index

The `ALTER` statement can be used to rebuild a domain index.

The same `ODCIIndexAlter()` routine is called as before, but with additional information about the `ALTER` option.

When the end user executes an `ALTER INDEX domain_index UPDATE BLOCK REFERENCES` for a domain index on an index-organized table (IOT), `ODCIIndexAlter()` is called with the `AlterIndexUpdBlockRefs` bit set. This gives you the opportunity to update guesses as to the block locations of rows that are stored in the domain index in logical rowids.

#### Example 8-7 Rebuilding a Domain Index

```
ALTER INDEX ResumeTextIndex REBUILD PARAMETERS (':Ignore off');
```

### 8.4.1.5 Truncating a Domain Index

There is no explicit statement for truncating a domain index. However, when the corresponding base table is truncated, the underlying storage table for the domain indexes are also truncated. Additionally, `ODCIIndexAlter()` is invoked by the command in [Example 8-8](#), and it truncates `ResumeTextIndex` because its `alter_option` is set to `AlterIndexRebuild`:

**Example 8-8 Truncating a Domain Index**

```
TRUNCATE TABLE MyEmployees;
```

### 8.4.1.6 Dropping a Domain Index

To drop an instance of a domain index, use the `DROP INDEX` statement, shown in [Example 8-9](#):

This results in Oracle calling the `ODCIIndexDrop()` method, passing it information about the index.

**Example 8-9 Dropping a Domain Index**

```
DROP INDEX ResumeTextIndex;
```

## 8.4.2 Domain Indexes on Index-Organized Tables

Consider some issues that arise when an indextype creates domain indexes on index-organized tables. You can use the `IndexOnIOT` bit of `IndexInfoFlags` in the `ODCIIndexInfo` structure to determine if the base table is an IOT.

### 8.4.2.1 About Rowid Storage in a UROWID Column

When the base table of a domain index is an index-organized table, and you want to store rowids for the base table in a table of your own, you should store the rowids in a `UROWID` (universal rowid) column if you are testing rowids for equality.

If the rowids are stored in a `VARCHAR` column instead, comparisons for textual equality of a rowid from the base table and a rowid from your own table fail in some cases where the rowids pick out the same row. This is because index-organized tables use logical instead of physical rowids, and, unlike physical rowids, logical rowids for the same row can have different textual representations. Two logical rowids are equivalent when they have the same primary key, regardless of the guess data block addresses stored with them.

A `UROWID` column can contain both physical and logical rowids. Storing rowids for an IOT in a `UROWID` column ensures that the equality operator succeeds on two logical rowids that have the same primary key information but different guess DBAs.

If you create an index storage table with a rowid column by performing a `CREATE TABLE AS SELECT` from the IOT base table, then a `UROWID` column of the correct size is created for you in your index table. If you create a table with a rowid column, then you must explicitly declare your rowid column to be of type `UROWID(x)`, where `x` is the size of the `UROWID` column. The size chosen should be large enough to hold any rowid from the base table; thus, it should be a function of the primary key from the base table. Use the query demonstrated by [Example 8-10](#) to determine a suitable size for the `UROWID` column.

Doing an `ALTER INDEX REBUILD` on index storage tables raises the same issues as doing a `CREATE TABLE` if you drop your storage tables and re-create them. If, on the other hand, you reuse your storage tables, no additional work should be necessary if your base table is an IOT.

## 8.4.2.2 Determining the Size of a UROWID Column

### Example 8-10 Getting the Size of a UROWID Column

```
SELECT (SUM(column_length + 3) + 7)
FROM user_ind_columns ic, user_indexes i
WHERE ic.index_name = i.index_name
AND i.index_type = 'IOT - TOP'
AND ic.table_name = base_table;
```

## 8.4.2.3 DML on Index Storage Tables

If you maintain a `UROWID` column in the index storage table, then you must change the type of the rowid bind variable in DML `INSERT`, `UPDATE`, and `DELETE` statements so that it works for all kinds of rowids. Converting the rowid argument passed in to a text string and then binding it as a text string works well for both physical and universal rowids. This strategy may help you to code your indextype to work with both regular tables and IOTs.

## 8.4.2.4 Start, Fetch, and Close Operations on Index Storage Tables

If you use an index scan-context structure to pass context between `Start`, `Fetch`, and `Close`, you must alter this structure. In particular, if you store the rowid define variable for the query in a buffer in this structure, then you must allocate the maximum size for a `UROWID` in this buffer (3800 bytes for universal rowids in byte format, 5072 for universal rowids in character format) unless you know the size of the primary key of the base table in advance or wish to determine it at run time. You must also store a bit in the context to indicate if the base table is an IOT, since `ODCIIndexInfo` is not available in `Fetch`.

As with DML operations, setting up the define variable as a text string works well for both physical and universal rowids. When physical rowids are fetched from the index table, you can be sure that their length is 18 characters. Universal rowids, however, may be up to 5072 characters long, so a string length function must be used to determine the actual length of a fetched universal rowid.

## 8.4.2.5 Indexes on Non-Unique Columns

All values of a primary key column must be unique, so a domain index defined upon a non-unique column of a table cannot use this column as the primary key of an underlying IOT used to store the index. To work around this, you can add a column in the IOT, holding the index data, to hold a unique sequence number. When a column value is inserted in the table, generate a unique sequence number to go with it; you can then use the indexed column with the sequence number as the primary key of the IOT. (Note that the sequence-number column cannot be a `UROWID` because `UROWID` columns cannot be part of a primary key for an IOT.) This approach also preserves the fast access to primary key column values that is a major benefit of IOTs.

## 8.4.3 Domain Index Metadata

For B-tree indexes, users can query the `USER_INDEXES` view to get index information. To provide similar support for domain indexes, you can provide domain-specific metadata in the following manner:

- Define one or more tables that contain this meta information. The key column of this table must be a unique identifier for the index. This unique key could be the index name (`schema.index`). The remainder of the columns can contain your metadata.
- Create views that join the system-defined metadata tables with the index meta tables to provide a comprehensive set of information for each instance of a domain index. It is your responsibility as the indextype designer to provide the view definitions.

## 8.4.4 Moving Domain Indexes Using Export/Import

Like B-tree and bitmap indexes, domain indexes are exported and subsequently imported when their base tables are exported. However, domain indexes can have implementation-specific metadata associated with them that is not stored in the system catalogs. For example, a text domain index can have associated policy information, a list of irrelevant words, and so on. The export/import mechanism moves this metadata from the source platform to the target platform.

To move the domain index metadata, the indextype must implement the `ODCIIndexGetMetadata()` interface method. When a domain index is being exported, this method is invoked and passes the domain index information. It can return any number of anonymous PL/SQL blocks that are written into the dump file and executed on import. If present, these anonymous PL/SQL blocks are executed immediately before the creation of the associated domain index.

By default, secondary objects of the domain are not imported or exported. However, if the interfaces `ODCIIndexUtilGetTableNames()` and `ODCIIndexUtilCleanup()` are present, the system invokes them to determine if the secondary objects associated with the domain indexes are part of the export/import operation.

### See Also:

- [ODCIIndexGetMetadata\(\)](#)
- [ODCIIndexUtilCleanup\(\)](#)
- [ODCIIndexUtilGetTableNames\(\)](#)
- *Oracle Database Utilities* for information about using Export/Import

## 8.4.5 Moving Domain Indexes Using Transportable Tablespaces

The **transportable tablespaces** feature lets you move tablespaces from one Oracle database into another. You can use transportable tablespaces to move domain index data as an alternative to exporting and importing it.

Moving data using transportable tablespaces can be much faster than performing either an export and import, or unload and load of the data because transporting a tablespace only requires copying datafiles and integrating tablespace structural information. Also, you do not have to rebuild the index afterward as you do when loading or importing. You can check for the presence of the `TransTblspc` flag in `ODCIIndexInfo` to determine whether the `ODCIIndexCreate()` call is the result of an imported domain index.

To use transportable tablespace for the secondary tables of a domain index, you must provide two additional ODCI interfaces, `ODCIIndexUtilGetTableNames()` and `ODCIIndexUtilCleanup()`, in the implementation type.

#### See Also:

*Oracle Database Administrator's Guide* for information about using transportable tablespaces

## 8.4.6 Domain Index Views

The following views provide information about secondary objects associated with domain indexes accessible to the user; they are only relevant for domain indexes.

- `ALL_SECONDARY_OBJECTS` provide information about secondary objects associated with domain indexes accessible to the user.
- `DBA_SECONDARY_OBJECTS` provides information about all secondary objects that are associated with domain indexes in the database.
- `USER_SECONDARY_OBJECTS` provides information about secondary objects associated with domain indexes owned by the current user.

**Table 8-2 Views \*\_SECONDARY\_OBJECTS**

Column	Data Type	Required	Description
<code>INDEX_OWNER</code>	<code>VARCHAR2(30)</code>	NOT NULL	Name of the domain index owner
<code>INDEX_NAME</code>	<code>VARCHAR2(30)</code>	NOT NULL	Name of the domain index
<code>SECONDARY_INDEX_OWNER</code>	<code>VARCHAR2(30)</code>	NOT NULL	Owner of the secondary object created by the domain index
<code>SECONDARY_INDEX_NAME</code>	<code>VARCHAR2(30)</code>	NOT NULL	Name of the secondary object created by the domain index
<code>SECONDARY_OBJDATA_TYPE</code>	<code>VARCHAR2(20)</code>	NOT NULL	Specifies if a secondary object is created by either indextype or statistics type

[Example 8-11](#) demonstrates how the `USER_SECONDARY_OBJECTS` view may be used to obtain information on the `ResumeTextIndex` that was created in [Example 8-4](#).



**Example 8-11 Using \*\_SECONDARY\_OBJECTS Views**

```
SELECT SECONDARY_OBJECT_OWNER, SECONDARY_OBJECT_NAME
FROM USER_SECONDARY_OBJECTS
WHERE INDEX_OWNER = USER and INDEX_NAME = 'ResumeTextIndex'
```

## 8.5 Object Dependencies, Drop Semantics, and Validation

Consider issues that affect objects used in domain indexes.

### 8.5.1 Object Dependencies

The dependencies among various objects are as follows:

- **Functions, Packages, and Object Types:** referenced by operators and indextypes
- **Operators:** referenced by indextypes, DML, and query SQL Statements
- **Indextypes:** referenced by domain indexes
- **Domain Indexes:** referenced (used implicitly) by DML and query SQL statements

Thus, the order in which these objects must be created, or their definitions exported for future import, is:

1. Functions, packages, and object types
2. Operators
3. Indextypes

### 8.5.2 Object Drop Semantics

The drop behavior for an object is as follows:

- **RESTRICT semantics:** if there are any dependent objects the drop operation is disallowed.
- **FORCE semantics:** the object is dropped even in the presence of dependent objects; any dependent objects are recursively marked invalid.

[Table 8-3](#) shows the default and explicit drop options supported for operators and indextypes. The other schema objects are included for completeness and context.

**Table 8-3 Default and Explicit Drop Options for Operators and Index Types**

Schema Object	Default Drop Behavior	Explicit Options Supported
Function	FORCE	None
Package	FORCE	None
Object Types	RESTRICT	FORCE
Operator	RESTRICT	FORCE
Indextype	RESTRICT	FORCE

## 8.5.3 Object Validation

Invalid objects are automatically validated, if possible, the next time they are referenced.

## 8.6 Indextype, Domain Index, and Operator Privileges

- To create an operator and its bindings, you must have `EXECUTE` privilege on the function, operator, package, or the type referenced in addition to `CREATE OPERATOR` or `CREATE ANY OPERATOR` privilege.
- To create an indextype, you must have `EXECUTE` privilege on the type that implements the indextype in addition to `CREATE INDEXTYPE` or `CREATE ANY INDEXTYPE` privilege. Also, you must have `EXECUTE` privileges on the operators that the indextype supports.
- To alter an indextype in your own schema, you must have `CREATE INDEXTYPE` system privilege.
- To alter an indextype or operator in another user's schema, you must have the `ALTER ANY INDEXTYPE` or `ALTER ANY OPERATOR` system privilege.
- To create a domain index, you must have `EXECUTE` privilege on the indextype in addition to `CREATE INDEX` or `CREATE ANY INDEX` privileges.
- To alter a domain index, you must have `EXECUTE` privilege on the indextype.
- To use the operators in queries or DML statements, you must have `EXECUTE` privilege on the operator and the associated function, package, and indextype.
- To change the implementation type, you must have `EXECUTE` privilege on the new implementation type.

## 8.7 Partitioned Domain Indexes

A domain index can be built to have discrete index partitions that correspond to the partitions of a range-, list-, hash-, or interval-partitioned table. Such an index is called a **local domain index**, as opposed to a *global* domain index, which has no index partitions. Local domain index refers to a partitioned index as a whole, not to the partitions that compose a local domain index.

### Note:

You cannot convert a global domain index into a local domain index by using the `ALTER TABLE MODIFY PARTITION BY` statement.

You also cannot use `ALTER TABLE MODIFY PARTITION BY` statement to modify the partitioning scheme of a table with any domain index defined on it.

### 8.7.1 Using Local Domain Index Methods

A local domain index is equipartitioned with the underlying table. That is, all keys in a local domain index refer to rows stored in its corresponding table partition, none refer

to rows in other partitions. You can provide for local domain indexes in the indextype by calling the `CREATE INDEXTYPE` statement, as demonstrated in [Example 8-12](#).

This statement specifies that the implementation type `TextIndexMethods` is capable of creating and maintaining local domain indexes.

#### Example 8-12 Using Local Domain Index Methods Within an Indextype

```
CREATE INDEXTYPE TextIndexType
  FOR Contains (VARCHAR2, VARCHAR2)
  USING TextIndexMethods
  WITH LOCAL PARTITION
  WITH SYSTEM MANAGED STORAGE TABLES;
```

## 8.7.2 About Partitioned Indexes

The `CREATE INDEX` statement creates and partitions the index, as demonstrated by [Example 8-13](#).

The `LOCAL [PARTITION]` clause indicates that the index is a local index on a partitioned table. You can specify partition names or allow Oracle to generate them.

The `PARALLEL` clause specifies that the index partitions are to be created in parallel. The [ODCIIndexAlter\(\)](#) routines, which correspond to index partition create, rebuild, or populate, are called in parallel.

In the `PARAMETERS` clause, specify the parameter string that is passed uninterpreted to the appropriate ODCI indextype routine. The maximum length of the parameter string is 1000 characters.

When you specify this clause at the top level of the syntax, the parameters become the default parameters for the index partitions. If you specify this clause as part of the `LOCAL [PARTITION]` clause, you override any default parameters with parameters for the individual partition. The `LOCAL [PARTITION]` clause can specify multiple partitions.

#### Example 8-13 Creating and Partitioning an Index

```
CREATE INDEX [schema.]index
  ON [schema.]table [t.alias] (indexed_column)
  INDEXTYPE IS indextype
  [LOCAL [PARTITION [partition [PARAMETERS ('string')]]] [...] ]
  [PARALLEL parallel_degree]
  [PARAMETERS ('string')];
```

## 8.7.3 Creating a Local Domain Index

When the domain index is created, Oracle invokes the appropriate ODCI routine. If the routine does not return successfully, the domain index is marked `FAILED`. The only operations supported on an failed domain index are `DROP INDEX` and (for non-local indexes) `REBUILD INDEX`. [Example 8-14](#) creates a local domain index `ResumeIndex`, shown in [Example 8-14](#).

#### Example 8-14 Creating a Local Domain Index

```
CREATE INDEX ResumeIndex ON MyEmployees(Resume)
  INDEXTYPE IS TextIndexType LOCAL;
```

## 8.7.4 Dropping a Local Domain Index

A specified index partition cannot be dropped explicitly. To drop a local index partition, you must drop the entire local domain index:

### Example 8-15 Dropping a Local Index Partition

```
DROP INDEX ResumeIndex;
```

## 8.7.5 Altering a Local Domain Index

The `ALTER INDEXTYPE` statement lets you change properties and the implementation type of an indextype without having to drop and re-create the indextype, then rebuild all dependent indexes.

Use the `ALTER INDEX` statement to perform the following operations on a local domain index:

- Rename the top level index.
- Modify the default parameter string for all the index partitions.
- Modify the parameter string associated with a specific partition.
- Rename an index partition.
- Rebuild an index partition.

### See Also:

<olink:SQLRF-GUID-BFA7E29C-7905-4811-9119-B20FD8EA18F2> for complete syntax of SQL statements.

## 8.7.6 Summary of Index States

Like a domain index, a partition of a local domain index can be in one or more of several states, listed in [Table 8-4](#).

**Table 8-4 Summary of Index States**

State	Description
IN_PROGRESS	The index or the index partition is in this state before and during the execution of the <code>ODCIIndex</code> DDL interface routines. The state is generally transitional and temporary. However, if the routine ends prematurely, the index could remain marked <code>IN_PROGRESS</code> .
FAILED	If the <code>ODCIIndex</code> interface routine doing DDL operations on the index returns an error, the index or index partition is marked <code>FAILED</code> .

**Table 8-4 (Cont.) Summary of Index States**

State	Description
UNUSABLE	Same as for regular indexes: An index on a partitioned table is marked UNUSABLE as a result of certain partition maintenance operations. Note that, for partitioned indexes, UNUSABLE is associated only with an index partition, not with the index as a whole.
VALID	An index is marked VALID if an object that the index directly or indirectly depends upon exists and is valid. This property is associated only with an index, never with an index partition.
INVALID	An index is marked INVALID if an object that the index directly or indirectly depends upon is dropped or invalidated. This property is associated only with an index, never with an index partition.

### 8.7.7 DML Operations with Local Domain Indexes

DML operations cannot be performed on the underlying table if an index partition of a local domain index is in any of these states: `IN_PROGRESS`, `FAILED`, or `UNUSABLE`. However, if the index is marked `UNUSABLE`, and `SKIP_UNUSABLE_INDEXES = true`, then index maintenance is not performed.

### 8.7.8 Table Operations that Affect Indexes

The following tables list operations that may be performed on the underlying table of an index and describe the effect, if any, on the index. [Table 8-5](#) lists `TABLE` operations, while [Table 8-6](#) lists `ALTER TABLE` operations.

**Table 8-5 Summary of Table Operations**

Table Operation	Description
<code>DROP table</code>	Drops the table. Drops all the indexes and their corresponding partitions
<code>TRUNCATE table</code>	Truncates the table. Truncates all the indexes and the index partitions

**Table 8-6 Summary of ALTER TABLE Operations with Partition Maintenance**

ALTER TABLE Operation	Description
Modify Partition Unusable local indexes	Marks the local index partition associated with the table partition as UNUSABLE
Modify Partition Rebuild Unusable local indexes	Rebuilds the local index partitions that are marked UNUSABLE and are associated with this table partition
Add Partition	Adds a new table partition. Also adds a new local index partition.
Coalesce Partition	Applicable to only hash partitioned tables. Drops a base table partition. Also drops the associated local index partition.
Drop Partition	Drops a base table partition. Also drops the associated local index partition
Truncate Partition	Truncate the table partition. Also truncates the associated local index partition

**Table 8-6 (Cont.) Summary of ALTER TABLE Operations with Partition Maintenance**

ALTER TABLE Operation	Description
Move Partition	Moves the base table partition to another tablespace. Corresponding local index partitions are marked <code>UNUSABLE</code> .
Split Partition	Splits a table partition into two partitions. Corresponding local index partition is also split. If the resulting partitions are non-empty, the index partitions are marked <code>UNUSABLE</code> .
Merge Partition	Merges two table partitions into one partition. Corresponding local index partitions should also merge. If the resulting partition contains data, the index partition is marked <code>UNUSABLE</code> .
Exchange Partition Excluding Indexes	Exchanges a table partition with a non-partitioned table. Local index partitions and global indexes are marked <code>UNUSABLE</code> .
Exchange Partition Including Indexes	Exchanges a table partition with a non-partitioned table. Local index partition is exchanged with global index on the non-partitioned table. Index partitions remain <code>USABLE</code> .

## 8.7.9 ODCIIndex Interfaces for Partitioning Domain Indexes

To support local domain indexes, you must implement the standard `ODCIIndex` methods, plus two additional methods that are specific to local domain indexes:

- [ODCIIndexExchangePartition\(\)](#)
- [ODCIIndexUpdPartMetadata\(\)](#)

## 8.7.10 Using SQL\*Loader for Domain Indexes

SQL\*Loader conventional path loads and direct path loads are supported for tables on which domain indexes are defined, with this limitation: The table must be heap-organized.

To do a direct path load on a domain index defined on an `IOT` or on a `LOB` column, perform these tasks:

1. Drop the domain index
2. Do the direct path load in SQL\*Loader.
3. Re-create the domain indexes.

## 8.8 Using System Partitioning

System Partitioning enables you to create a single table consisting of multiple physical partitions. System partitioning does not use partitioning keys. Instead, it creates the number of partitions specified. Therefore, the resulting partitions have no bounds (range), values (list), or a partitioning method.

Because there are no partitioning keys, you must explicitly map the distributed table rows to the destination partition. When inserting a row, for example, you must use the partition extended syntax to specify the partition to which a row must be mapped.

**See Also:**Supporting SQL syntax in the *Oracle Database SQL Language Reference*

## 8.8.1 Advantages of System Partitioned Tables

The main advantages of system-partitioned tables is that it can be used to create and maintain tables that are equipartitioned with respect to another table. For example, this means that a dependent table could be created as a system-partitioned table, with the same number of partitions as the base table. It follows that such a system-partitioned table can be used to store index data for a domain index, with the following implications:

- Pruning follows the base table pruning rules: when a partition is accessed in the base table, the corresponding partition can be accessed in the system-partitioned table.
- DDLs of the base table can be duplicated on the system-partitioned table. Therefore, if a partition is dropped on the base table, the corresponding partition on the system-partitioned table is dropped automatically.

## 8.8.2 Implementing System Partitioning

Consider how to implement system partitioning.

### 8.8.2.1 Creating a System-Partitioned Table

[Example 8-16](#) describes how to create a system-partitioned table with four partitions. Each partition can have different physical attributes.

#### **Example 8-16** Creating System-Partitioned Tables

```
CREATE TABLE SystemPartitionedTable (c1 integer, c2 integer)
PARTITION BY SYSTEM
(
  PARTITION p1 TABLESPACE tbs_1,
  PARTITION p2 TABLESPACE tbs_2,
  PARTITION p3 TABLESPACE tbs_3,
  PARTITION p4 TABLESPACE tbs_4
);
```

### 8.8.2.2 Inserting Data into a System-Partitioned Table

[Example 8-17](#) demonstrates how to insert data into a system-partitioned table. Both `INSERT` and `MERGE` statements (not shown here) must use the partition extended syntax to identify the partition to which the row should be added. The tuple (4,5) could have been inserted into any of the four partitions created in [Example 8-16](#).

`DATAOBJ_TO_PARTITION` can also be used, as demonstrated by [Example 8-18](#).

Starting with Oracle Database 12c, Oracle recommends using `DATAOBJ_TO_MAT_PARTITION`, as demonstrated in [Example 8-19](#), instead of the `DATAOBJ_TO_PARTITION` function. The `DATAOBJ_TO_MAT_PARTITION` function supports local domain indexes on interval partitioned tables.

Note that the first line of code shows how to insert data into a named partition, while the second line of code shows that data can also be inserted into a partition based on the partition's order. The support for bind variables, illustrated on the third code line, is important because it allows cursor sharing between `INSERT` statements.

The `DATAOBJ_TO_PARTITION` function shown in [Example 8-18](#) determines the absolute partition number, given the physical partition identifier. However, if the base table is interval partitioned, then there might be holes in the partition numbers corresponding to unmaterialized partitions. Because the system partitioned table only has materialized partitions, `DATAOBJ_TO_PARTITION` numbers can cause a mis-match between the partitions of the base table and the partitions of the underlying system partitioned index storage tables.

The new function, `DATAOBJ_TO_MAT_PARTITION`, shown in [Example 8-19](#), returns the materialized partition number (as opposed to the absolute partition number) and helps keep the two tables in sync. Index types planning to support local domain indexes on interval partitioned tables should migrate to the use of this function.

#### Example 8-17 Inserting Data into System-Partitioned Tables

```
INSERT INTO SystemPartitionedTable PARTITION (p1) VALUES (4,5);
```

#### Example 8-18 Inserting Data into System-Partitioned Tables; DATAOBJ\_TO\_PARTITION

```
INSERT INTO SystemPartitionedTable PARTITION  
  (DATAOBJ_TO_PARTITION (base_table, :physical_partid))  
  VALUES (...);
```

#### Example 8-19 Inserting Data into System-Partitioned Tables; DATAOBJ\_TO\_MAT\_PARTITION

```
INSERT INTO SystemPartitionedTable PARTITION  
  (DATAOBJ_TO_MAT_PARTITION (base_table, :physical_partid))  
  VALUES (...);
```

### 8.8.2.3 Deleting and Updating Data in a System-Partitioned Table

While delete and update operations do not require the partition extended syntax, Oracle recommends that you use it if at all possible. Because there is no partition pruning, the entire table is scanned to execute the operation if the partition-extended syntax is omitted. This highlights the fact that there is no implicit mapping between the rows and the partitions.

### 8.8.3 Supporting Operations with System-Partitioned Tables

The following operations continue to be supported by system partitioning:

- Partition maintenance operations and other DDLs, with the exception of:
  - `ALTER INDEX SPLIT PARTITION`
  - `ALTER TABLE SPLIT PARTITION`
  - `CREATE TABLE (AS SELECT)`
- Creation of local indexes, with the exception of unique local indexes because they require a partitioning key
- Creation of local bitmapped indexes



- Creation of global indexes
- All DML operations
- `INSERT AS SELECT` operations with partition extended syntax, as shown in the following code example:

#### Inserting Data into a Particular Partition of a Table

```
INSERT INTO TableName
PARTITION (
    PartitionName |
    DATAOBJ_TO_MAT_PARTITION(base_table, :physical_partid)
AS SubQuery
```

The following operations are no longer supported by system partitioning because system partitioning does not use a partitioning method, and therefore does not distribute rows to partitions.

- `CREATE TABLE AS SELECT` An alternative approach is to first create the table, and then insert rows into each partition.
- `INSERT INTO TableName AS SubQuery`

## 8.8.4 Running Partition Maintenance Operations

As an example, consider an `ALTER TABLE SPLIT PARTITION` routine issued for the base table of a domain index.

1. The system invokes the `ODCIIndexUpdPartMetadata()` method using the information about the partition being added or dropped; remember that a 1:2 split involves dropping of one partition and adding two new partitions.
2. The system invokes the `ODCIStatsUpdPartStatistics()` on the affected partitions.
3. The system drops the partition that has been split from all system-partition index and statistics storage tables.
4. The system adds two new partitions to the system-partitioned tables.
5. If the partition that is being split is empty, then one call to `ODCIIndexAlter()` rebuilds the split partition, and a second call to `ODCIIndexAlter()` rebuilds the newly added partition.

## 8.8.5 Altering Table Exchange Partitions with Indexes

The `ALTER TABLE EXCHANGE PARTITION` command is allowed for tables with domain indexes only under the following circumstances:

- a domain index is defined on both the non-partitioned table, and the partitioned table
- both the non-partitioned table and the partitioned table have the same associated indextype

 **Note:**

The `ALTER TABLE EXCHANGE PARTITION CASCADE` command is not allowed if there is a local domain index on the reference partitioned table.

The `ALTER TABLE EXCHANGE PARTITION` routine invokes the following user-implemented methods:

1. `ODCIIndexExchangePartition()` for the affected partition and index
2. `ODCIStatsExchangePartition()` for the affected partition and index if statistics are collected for them

## 8.9 Using System-Managed Domain Indexes

Consider how system-managed domain indexes work, how to collect and store statistics for them, and restrictions on their use.

Let us examine how system-managed domain indexes work.

Figure 8-1 illustrates the initial setup of a base table `T1`. `T1` has the following elements:

- three partitions
- a local domain index on one of its columns, `IT1`
- a table of corresponding metadata objects, `MT1`, which is the optional metadata table created by the indextype to store information specific to each partition of the local domain index
- a system-partitioned table, `SPT1`, created by the indextype to store index data

The structures shown in these tables (table `T1`, index `IT1` and the system partitioned table `SPT1`) have the same number of partitions, in a one-to-one relationship. The metadata table `MT1` has as many rows as the number of partitions in these tables.

**Figure 8-1 Three-Partition Table with a Local Domain Index, and Associated Structures****Server Tables****Base Table (T1)**

PartName	PartNum
P1	1
P2	2
P3	3

**Local Index (IT1)**

PartName	PartNum
IP1	1
IP2	2
IP3	3

**Index Tables****Metadata Table (MT1)**

PartName	PartId	Metadata
IP1	101	Params1
IP2	102	Params2
IP3	103	Params3

**System Partitioned Table (SPT1)**

PartName	PartNum
IP1	1
IP2	2
IP3	3

Figure 8-2 illustrates what happens to T1 and its related structures after splitting one of its partitions with the operation in Example 8-20:

- the partition P2 in the base table T1 splits into P21 and P22
- in the local domain index, partition IP2 is dropped and two new partitions, IP21 and IP22, are created
- the indextype invokes the `ODCIIndexUpdPartMetadata()` method that makes the necessary updates to the metadata table MT1
- in the system partitioned table SPT1, the partition that corresponds to partition IP2 is dropped and two new partitions are created
- index partitions are marked `UNUSABLE` as a result of the split operation; they must be rebuilt to make them `USABLE`

**Figure 8-2 A Three-Partition Table after ALTER TABLE SPLIT PARTITION**

**Server Tables**

**Base Table (T1)**

PartName	PartNum
P1	1
P21	2
P22	3
P3	4

**Local Index (IT1)**

PartName	PartNum
IP1	1
IP21	2
IP22	3
IP3	4

**Index Tables**

**Metadata Table (MT1)**

PartName	PartId	Metadata
IP1	101	Params1
IP21	1021	Params2
IP22	1022	Params2
IP3	103	Params3

**System Partitioned Table (SPT1)**

PartName	PartNum
IP1	1
IP21	2
IP22	3
IP3	4

**Example 8-20 Splitting an Existing Table Partition**

```
ALTER TABLE T1 SPLIT PARTITION P2 INTO P21, P22
```

## 8.10 Designing System-Managed Domain Indexes

When a top-level DDL that affects a non-partitioned domain index is called, the system invokes user-implemented `ODCIIndexXXX()` and `ODCIStatsXXX()` methods. [Table 8-7](#) shows these methods.

When a top-level DDL that affects a local system managed domain index is called, the system invokes user-implemented `ODCIIndexXXX()` and `ODCIStatsXXX()` methods. [Table 8-8](#) shows these methods. In summary, the following rules apply:

- For `ODCIIndexXXX()` DMLs and queries, both the index partition object identifier (`ODCIIndexInfo.IndexPartitionIden`) and a base table partition physical identifier (`ODIIndexInfo.IndexCols(1).TablePartitionIden`) are required. For `ODCIIndexXXX()` DDL routines, both the index partition object identifier and the index partition name are supplied.
- The `CREATE INDEX` routine uses two calls to `ODCIIndexCreate()` (one at the beginning and one at the end), and as many calls to `ODCIIndexAlter()` with `alter_option=AlterIndexRebuild` as there are partitions.

- The TRUNCATE TABLE routine uses as many calls to [ODCIIndexAlter\(\)](#) with `alter_option=AlterIndexRebuild` as there are partitions.
- All partition maintenance operations invoke [ODCIIndexUpdPartMetadata\(\)](#) so that the indextype correctly updates its partition metadata table. The list of index partitions is specified by the index partition name and the index partition object identifier, and is supplied with information regarding addition or dropping of the partition. No DDLs are allowed in these calls. With each partition maintenance operation, the system implicitly transforms the system-partitioned storage tables that were created using domain indexes. The names of the newly generated partitions correspond to the index partition names.
- If the system-partitioned tables are used to store partition-level statistics, then the tables and indexes created by [ODCIStatsCollect\(\)](#) and dropped by [ODCIStatsDelete\(\)](#) are tracked by the system to ensure that they remain equipartitioned.
- If the application implements user-defined partition-level statistics, the system invokes [ODCIStatsUpdPartStatistics\(\)](#) with every partition maintenance operation. This ensure that the statistics type updates its partition-level statistics, and (optionally) its aggregate global statistics. No DDLs are allowed in these calls. If [ODCIStatsUpdPartStatistics\(\)](#) is not implemented, the system does not raise an exception but proceeds to the next programmatic step.

## 8.10.1 Methods for Non-Partitioned Domain Indexes

**Table 8-7 ODCIXXX() Methods for Non-Partitioned Domain Indexes**

DDL	ODCIXXX() Method Used in System-Managed Approach
CREATE INDEXTYPE	Specify the system-managed approach
CREATE INDEX	<a href="#">ODCIIndexCreate()</a>
TRUNCATE TABLE	<a href="#">ODCIIndexAlter()</a> , with the <code>alter_option=AlterIndexRebuild</code>
ALTER INDEX	<a href="#">ODCIIndexAlter()</a>
GATHER_INDEX_STATS() in DBMS_STATS	<a href="#">ODCIStatsCollect()</a>
DELETE_INDEX_STATS() in DBMS_STATS	<a href="#">ODCIStatsDelete()</a>
DROP INDEX (Force)	<a href="#">ODCIIndexDrop()</a> and <a href="#">ODCIStatsDelete()</a>
INSERT	<a href="#">ODCIIndexInsert()</a>
DELETE	<a href="#">ODCIIndexDelete()</a>

**Table 8-7 (Cont.) ODCIXXX() Methods for Non-Partitioned Domain Indexes**

DDL	ODCIXXX() Method Used in System-Managed Approach
UPDATE	<a href="#">ODCIIndexUpdate()</a>
QUERY	<a href="#">ODCIIndexStart()</a> , <a href="#">ODCIIndexFetch()</a> and <a href="#">ODCIIndexClose()</a>

## 8.10.2 Methods for Local System-Managed Domain Indexes

**Table 8-8 ODCIXXX() Methods for Local System-Managed Domain Indexes**

DDL	ODCIXXX() Method Used in System-Managed Approach
CREATE INDEXTYPE	Specify the system-managed approach
CREATE INDEX	One call to <a href="#">ODCIIndexCreate()</a> , one <a href="#">ODCIIndexAlter()</a> call for each partition, with <code>alter_option=AlterIndexRebuild</code> , and then a final call to <a href="#">ODCIIndexCreate()</a>
TRUNCATE TABLE	One call for each partition: <a href="#">ODCIIndexAlter()</a> , with <code>alter_option=AlterIndexRebuild</code>
ALTER INDEX	<a href="#">ODCIIndexAlter()</a>
GATHER_INDEX_STATS() in DBMS_STATS	One call to <a href="#">ODCIStatsCollect()</a>
DELETE_INDEX_STATS() in DBMS_STATS	One call to <a href="#">ODCIStatsDelete()</a>
DROP INDEX (Force)	<a href="#">ODCIIndexDrop()</a> , and if user-defined statistics have been collected then <a href="#">ODCIStatsDelete()</a>
ALTER TABLE ADD PARTITION	<a href="#">ODCIIndexUpdPartMetadata()</a> , <a href="#">ODCIIndexAlter()</a> with <code>alter_option=AlterIndexRebuild</code>
ALTER TABLE COALESCE PARTITION	<a href="#">ODCIIndexUpdPartMetadata()</a> ; <a href="#">ODCIStatsUpdPartStatistics()</a> if statistics are collected
ALTER TABLE DROP PARTITION	<a href="#">ODCIIndexUpdPartMetadata()</a> ; <a href="#">ODCIStatsUpdPartStatistics()</a> if statistics are collected
ALTER TABLE TRUNCATE PARTITION	<a href="#">ODCIIndexUpdPartMetadata()</a> ; <a href="#">ODCIIndexAlter()</a> with <code>alter_option=AlterIndexRebuild</code> ; <a href="#">ODCIStatsUpdPartStatistics()</a> if a statistics type is associated with the indextype and if user-defined statistics have been collected

**Table 8-8 (Cont.) ODCIXXX() Methods for Local System-Managed Domain Indexes**

DDL	ODCIXXX() Method Used in System-Managed Approach
ALTER TABLE SPLIT PARTITION	<a href="#">ODCIIndexUpdPartMetadata()</a> ; <a href="#">ODCIIndexAlter()</a> with <code>alter_option=AlterIndexRebuild</code> only if the result partitions are empty; <a href="#">ODCIStatsUpdPartStatistics()</a> if a statistics type is associated with the indextype and if user-defined statistics have been collected
ALTER TABLE MERGE PARTITION	<a href="#">ODCIIndexUpdPartMetadata()</a> ; <a href="#">ODCIIndexAlter()</a> with <code>alter_option=AlterIndexRebuild</code> only if the result partitions are empty; <a href="#">ODCIStatsUpdPartStatistics()</a> if a statistics type is associated with the indextype and if user-defined statistics have been collected
ALTER TABLE EXCHANGE PARTITION	<a href="#">ODCIIndexExchangePartition()</a> ; if a statistics type is associated with the indextype, and if user-defined statistics have been collected, also <a href="#">ODCIStatsExchangePartition()</a>
ALTER TABLE MOVE PARTITION	<a href="#">ODCIIndexUpdPartMetadata()</a> if a partitioned table has a valid system-managed local domain index that has been updated as part of a partition MOVE and rename operation. If a partition is moved without updating the system-managed indexes, the index partition is marked UNUSABLE.
GATHER_TABLE_STATS() in DBMS_STATS	One call to <a href="#">ODCIStatsCollect()</a>
DELETE_TABLE_STATS() in DBMS_STATS	One call to <a href="#">ODCIStatsDelete()</a> , if a statistics type is associated with the indextype, and if user-defined statistics have been collected
ALTER INDEX PARTITION	<a href="#">ODCIIndexAlter()</a>
INSERT	<a href="#">ODCIIndexInsert()</a>
DELETE	<a href="#">ODCIIndexDelete()</a>
UPDATE	<a href="#">ODCIIndexUpdate()</a>
QUERY	<a href="#">ODCIIndexStart()</a> , <a href="#">ODCIIndexFetch()</a> and <a href="#">ODCIIndexClose()</a>

## 8.11 Creating Local Domain Indexes

The `CREATE INDEX` routine implements the following steps:

1. To create system-partitioned storage tables, the system calls `ODCIIndexCreate()` with index information. The number of partitions is supplied in the `ODCIIndexInfo.IndexPartitionTotal` attribute. Note that all the partitioned storage tables should be system-partitioned.

The object-level `CREATE` routine passes in only the object-level parameter string. To construct the storage attributes for all partitions, the indextype needs partition-level

parameter strings. To obtain these, the cartridge must programmatically query the `XX_IND_PARTITIONS` or `XXX_IND_SUBPARTITIONS` views on the dictionary tables.

Oracle recommends that the indextype assign names to the storage tables and its partitions using the index partition name. Note that you must also obtain index partition names programmatically, from the `XXX_IND_PARTITIONS` or `XXX_IND_SUBPARTITIONS` views.

2. For each partition, the system calls the `ODCIIndexAlter()` method with `alter_option=AlterIndexRebuild`.

You can verify if this `ODCIIndexAlter()` call has been made as part of a `CREATE INDEX` call by checking whether the `ODICEnv.IntermediateCall` bit was set.

Programmatically select the index column values for each partition from the base table partition, transform them, and store the transformed data in the corresponding system-partitioned table.

During DML or query operations, if the indextype must refer to the metadata table, it should be programmed to insert the index partition object identifier into the corresponding row of the metadata table.

To store values in non-partitioned tables, you can program the cartridge either at the level of the initial `ODCIIndexCreate()` call, or at the level of the `ODCIIndexAlter()` calls made for each partition.

3. The system makes a final call to the `ODCIIndexCreate()` method so that the indextype can create any necessary indexes on the storage tables.

The `CREATE` routine may use temporary storage tables for intermediate data. As an option, you can programmatically instruct your application to use external files; it is then the application's responsibility to manage these files.

After this `ODCIIndexCreate()` call completes, all partitioned tables created and not dropped by this call are managed by the system.

Note that creation of global indexes of any type on a system-partitioned index storage table is flagged as an error.

#### See Also:

- [ODCIIndexAlter\(\)](#)
- [ODCIIndexCreate\(\)](#)

## 8.12 Maintaining Local Domain Indexes with INSERT, DELETE, and UPDATE

DML operations should be implemented in the following manner:

1. One of `ODCIIndexInsert()`, `ODCIIndexDelete()`, or `ODCIIndexUpdate()` is invoked. Both the index partition object identifier (for accessing the metadata table) and the base table partition physical identifier (for performing DMLs in the corresponding partition) are supplied as part of the `ODCIIndexInfo` structure.



2. To implement DMLs on a system-partitioned table, the cartridge code must include the syntax in the following code example. The `DATAOBJ_TO_MAT_PARTITION()` function is provided by the system.

#### Calling DML Operations on System-Partitioned Tables

```
INSERT INTO SP PARTITION
(DATAOBJ_TO_MAT_PARTITION(base_table, :physical_partid)) VALUES(...)
```

## 8.13 Querying Local Domain Indexes

Follow these steps to query local domain indexes:

1. When the optimizer receives a query that has a user-defined operator, if it determines to use a domain index scan for evaluation, `ODCIIndexStart()`, `ODCIIndexFetch()`, or `ODCIIndexClose()` is invoked.
2. The index partition object identifier and the base table partition physical identifier are passed in as part of `ODCIIndexInfo` structure.
3. The index partition object identifier can be used to look up the metadata table, if necessary.
4. And the base table physical partition identifier can be used to query the corresponding partition of the system partitioned table.
5. The cartridge code must use the syntax as shown in the following code example and the provided function `DATAOBJ_TO_MAT_PARTITION()`, for querying the system partitioned table.

#### Querying a System-Partitioned Table

```
SELECT FROM SP PARTITION
(DATAOBJ_TO_MAT_PARTITION(base_table, :physical_partid)) WHERE <..>;
```

## 8.14 System Managed Domain Index - Supported Schemes

The system-managed domain indexing approach supports the following:

- Non-partitioned system-managed domain indexes.
- Local indexes on range-partitioned, list-partitioned, hash-partitioned, interval-partitioned, and composite-partitioned tables.
- Local indexes on reference partitioned tables when the root table of the reference partitioned table is range-partitioned, list-partitioned, hash-partitioned, interval-partitioned, range-composite partitioned, list-composite partitioned, or hash-composite partitioned.

## 8.15 Restrictions of System-Managed Domain Indexing

- A system-managed domain index can index only a single column.
- Local domain indexes cannot be created for `REF`-partitioned tables or `IOTS`.
- Local domain indexes on reference partitioned tables are not supported when the root table of the reference partitioned table is interval-composite partitioned, or interval-subpartitioned.

- Local domain indexes are not supported on interval-composite, interval-subpartitioned, auto list-partitioned, auto list-composite, or auto list subpartitioned tables.
- A bitmap or unique domain index cannot be specified.

## 8.16 Migrating Non-Partitioned Indexes

The following steps show how to migrate non-partitioned user-managed domain indexes into system-managed domain indexes.

1. Modify metadata: issue an `ALTER INDEXTYPE` command to register the property of the indextype with the system. This disassociates the statistics type.
2. The index is marked as `INVALID`. You must implicitly issue an `ALTER INDEX ... COMPILE` command to validate the index again. This calls the `ODCIIndexAlter()` method with `alter_option=AlterIndexMigrate`.
3. Issue an `ASSOCIATE STATISTICS` command to associate a system-managed statistics type with the system-managed indextype.

## 8.17 Migrating Local Partitioned Indexes

The following steps show how to migrate local partitioned user-managed domain indexes into system-managed equi-partitioned domain indexes.

1. Modify metadata: issue an `ALTER INDEXTYPE` command to register the new index routines and the property of the indextype so it can be managed by the system. All indexes of this indextype are marked `INVALID`, and cannot be used until after the completion of the next step. This disassociates the statistics type and erases the old statistics.
2. Modify index data: invoke the `ALTER INDEX ... COMPILE` command for the new indextype of each index. This calls the `ODCIIndexAlter()` method with `alter_option=AlterIndexMigrate`. You must implement this method to transform groups on non-partitioned tables into system-partitioned tables. For each set of  $n$  tables that represent a partitioned table, the cartridge code should perform the following actions. Note that the migration does not require re-generation of index data, but involves only exchange operations.
  - Create a system-partitioned table.
  - For each of the  $n$  non-partitioned tables, call the `ALTER TABLE EXCHANGE PARTITION [INCLUDING INDEXES]` routine to exchange a non-partitioned table for a partition of the system-partitioned table.
  - Drop all  $n$  non-partitioned tables.
3. Issue an `ASSOCIATE STATISTICS` command to associate a system-managed statistics type with the system-managed indextype.

# 9

## Defining Operators

You can define operators and use them with and without indextypes.

### 9.1 User-Defined Operators

A **user-defined operator** is a top-level schema object. In many ways, user-defined operators act like the built-in operators such as <, >, and =; for instance, they can be invoked in all the same situations. They contribute to ease of use by simplifying SQL statements, making them shorter and more readable.

User-defined operators are:

- Identified by names, which are in the same namespace as tables, views, types, and standalone functions
- Bound to functions, which define operator behavior in specified contexts
- Controlled by privileges, which indicate the circumstances in which each operator can be used
- Often associated with indextypes, which can be used to define indexes that are not built into the database

#### See Also:

*Oracle Database SQL Language Reference* for detailed information on syntax and privileges

#### 9.1.1 Operator Bindings

An operator **binding** associates the operator with the **signature** of a function that implements the operator. A signature consists of a list of the data types of the arguments of the function, in order of occurrence, and the function's return type. Operator bindings tell Oracle which function to execute when the operator is invoked. An operator can be bound to several functions if each function has a different signature. To be considered different, functions must have different argument lists. Functions whose argument lists match, but whose return data types do not match, are not considered different and cannot be bound to the same operator.

Operators can be bound to:

- Standalone functions
- Package functions
- User-defined type member methods

Operators can be bound to functions and methods in any accessible schema. Each operator must have at least one binding when you create it. If you attempt to specify non-unique operator bindings, the Oracle server raises an error.

## 9.1.2 Operator Privileges

To create an operator and its bindings, you must have:

- `CREATE OPERATOR` or `CREATE ANY OPERATOR` privilege
- `EXECUTE` privilege on the function, operator, package, or type referenced

To drop a user-defined operator, you must own the operator or have the `DROP ANY OPERATOR` privilege.

To invoke a user-defined operator in an expression, you must own the operator or have `EXECUTE` privilege on it.

## 9.1.3 Creating Operators

To create an operator, specify its name and its bindings with the `CREATE OPERATOR` statement. [Example 9-1](#) creates the operator `Contains()`, binding it to functions that provide implementations in the Text and Spatial domains.

### Example 9-1 Creating an Operator

```
CREATE OPERATOR Contains
BINDING
(VARCHAR2, VARCHAR2) RETURN NUMBER USING text.contains,
(Spatial.Geo, Spatial.Geo) RETURN NUMBER USING Spatial.contains;
```

## 9.1.4 Dropping Operators

To drop an operator and all its bindings, specify its name with the `DROP OPERATOR` statement. [Example 9-2](#) drops the operator `Contains()`.

The default `DROP` behavior is `DROP RESTRICT`: if there are dependent indextypes or ancillary operators for any of the operator bindings, then the `DROP` operation is disallowed.

To override the default behavior, use the `FORCE` option. [Example 9-3](#) drops the operator and all its bindings and marks any dependent indextype objects and dependent ancillary operators invalid.

### Example 9-2 Dropping an Operator; RESTRICT Option

```
DROP OPERATOR Contains;
```

### Example 9-3 Dropping an Operator; FORCE Option

```
DROP OPERATOR Contains FORCE;
```

## 9.1.5 Altering Operators

You can add bindings to or drop bindings from an existing operator with the `ALTER OPERATOR` statement. [Example 9-4](#) adds a binding to the operator `Contains()`.

### Example 9-4 Adding a Binding to an Operator

```
ALTER OPERATOR Contains
  ADD BINDING (music.artist, music.artist) RETURN NUMBER
  USING music.contains;
```

## 9.1.5.1 Necessary Privileges for ALTER OPERATOR

To alter an operator, the operator must be in your own schema, or you must have the `ALTER ANY OPERATOR` privilege. You must also have `EXECUTE` privileges on the operators and functions referenced.

## 9.1.5.2 Restrictions of ALTER OPERATOR

The following restrictions apply to the `ALTER OPERATOR` statement:

- You can only issue `ALTER OPERATOR` statements that relate to existing operators.
- You can only add or drop one binding in each `ALTER OPERATOR` statement.
- You cannot drop an operator's only binding with `ALTER OPERATOR`; use the `DROP OPERATOR` statement to drop the operator. An operator cannot exist without any bindings.
- If you add a binding to an operator associated with an indextype, the binding is not associated to the indextype unless you also issue the `ALTER INDEXTYPE ADD OPERATOR` statement

## 9.1.6 Commenting Operators

To add comment text to an operator, specify the name and text with the `COMMENT` statement. [Example 9-5](#) supplies information about the `Contains()` operator:

Comments on operators are available in the data dictionary through these views:

- `USER_OPERATOR_COMMENTS`
- `ALL_OPERATOR_COMMENTS`
- `DBA_OPERATOR_COMMENTS`

You can only comment operators in your own schema unless you have the `COMMENT ANY OPERATOR` privilege.

### Example 9-5 Adding COMMENTS to an Operator

```
COMMENT ON OPERATOR
  Contains IS 'a number that indicates if the text contains the key';
```

## 9.1.7 About Invoking Operators

Like built-in operators, user-defined operators can be invoked wherever expressions can occur. For example, user-defined operators can be used in:

- The select list of a `SELECT` command.
- The condition of a `WHERE` clause.
- The `ORDER BY` and `GROUP BY` clauses.

When an operator is invoked, Oracle evaluates the operator by executing a function bound to it. When several functions are bound to the operator, Oracle executes the function whose argument data types match those of the invocation (after any implicit type conversions). Invoking an operator with an argument list that does not match the signature of any function bound to that operator causes an error to be raised. Because user-defined operators can have multiple bindings, they can be used as overloaded functions.

Assume that [Example 9-6](#) creates the operator `Contains()`.

If `Contains()` is used in [Example 9-7](#), the operator invocation `Contains(resume, 'Oracle')` causes Oracle to execute the function `text.contains(resume, 'Oracle')` because the signature of the function matches the data types of the operator arguments. Similarly, the operator invocation `Contains(location, :bay_area)` executes the function `spatial.contains(location, :bay_area)`.

Executing the statement in [Example 9-8](#) raises an error because none of the operator bindings satisfy the argument data types.

### 9.1.7.1 Creating Contains() Operator

#### Example 9-6 Creating the Contains() Operator

```
CREATE OPERATOR Contains
BINDING
(VARCHAR2, VARCHAR2) RETURN NUMBER
USING text.contains,
(spatial.geo, spatial.geo) RETURN NUMBER
USING spatial.contains;
```

### 9.1.7.2 Using Contains() Operator in a Query

#### Example 9-7 Using the Operator Contains() in a Query

```
SELECT * FROM MyEmployees
WHERE Contains(resume, 'Oracle')=1 AND Contains(location, :bay_area)=1;
```

### 9.1.7.3 Using Contains() Operator Incorrectly

#### Example 9-8 An Incorrect Use of the Operator Contains()

```
SELECT * FROM MyEmployees
WHERE Contains(address, employee_addr_type('123 Main Street', 'Anytown', 'CA',
'90001'))=1;
```

## 9.2 Operators and Indextypes

Operators are often defined in connection with indextypes. After creating the operators with their functional implementations, you can create an indextype that supports evaluations of these operators using an index scan.

Operators that occur outside `WHERE` clauses are essentially stand-ins for the functions that implement them; the meaning of such an operator is determined by its functional implementation. Operators that occur in `WHERE` clauses are sometimes evaluated using functional implementations; at other times they are evaluated by index scans.

## 9.2.1 Operators in the WHERE Clause

Operators appearing in the `WHERE` clause can be evaluated efficiently by an index scan using the scan methods provided by the indextype. This process involves the following steps.

1. Creating an indextype that supports the evaluation of the operator
2. Recognizing operator predicates of a certain form
3. Selecting a domain index
4. Setting up an appropriate index scan
5. Executing the index scan methods

### 9.2.1.1 Using Operator Predicates

An indextype supports efficient evaluation of operator predicates that can be represented by a range of lower and upper bounds on the operator return values. Specifically, predicates of the forms listed in [Example 9-9](#) are candidates for index scan-based evaluation.

Operator predicates that Oracle can convert internally into one of the forms in [Example 9-9](#) can also make use of the index scan-based evaluation.

Using the operators in expressions, such as `op(...) + 2 = 3`, precludes index scan-based evaluation.

Predicates of the form `op() IS NULL` are evaluated using the functional implementation.

#### Example 9-9 Operator Predicates

```
op(...) LIKE value_expression  
op(...) relop value_expression
```

where *value\_expression* must be evaluated to a constant (not a column) that can be used as a domain index key, and *relop* is one of `<`, `<=`, `=`, `>=`, or `>`

### 9.2.1.2 Resolving Query Results with the Contains() Operator

An index scan-based evaluation of an operator is only possible if the operator applies to a column or object attribute indexed by an indextype. The optimizer makes the final decision between the indexed implementation and the functional implementation, taking into account the selectivity and cost while generating the query execution plan.

Consider the query in [Example 9-10](#).

The optimizer can choose to use a domain index in evaluating the `Contains()` operator if

- The `resume` column has a defined index.
- The index is of type `TextIndexType`.
- `TextIndexType` supports the appropriate `Contains()` operator.

If any of these conditions do not hold, Oracle performs a complete scan of the `MyEmployees` table and applies the functional implementation of `Contains()` as a post-filter. However, if all these conditions are met, the optimizer uses selectivity and cost

functions to compare the cost of index-based evaluation with the full table scan and generates the appropriate execution plan.

Consider a slightly different query in [Example 9-11](#).

Here, you can access the `MyEmployees` table through an index on the `id` column, one on the `resume` column, or a bitmap merge of the two. The optimizer estimates the costs of the three plans and picks the least expensive variant one, which could be to use the index on `id` and apply the `Contains()` operator on the resulting rows. In that case, Oracle would use the functional implementation of `Contains()` rather than the domain index.

#### Example 9-10 Using the Contains() Operator in a Simple Query

```
SELECT * FROM MyEmployees WHERE Contains(resume, 'Oracle') = 1;
```

#### Example 9-11 Using the Contains() Operator in a Complex Query

```
SELECT * FROM MyEmployees WHERE Contains(resume, 'Oracle') =1 AND id =100;
```

### 9.2.1.3 Setting Up an Index Scan

If a domain index is selected for the evaluation of an operator predicate, an index scan is set up. The index scan is performed by the scan methods `ODCIIndexStart()`, `ODCIIndexFetch()`, and `ODCIIndexClose()`, specified as part of the corresponding indextype implementation. The `ODCIIndexStart()` method is invoked with the operator-related information, including name and arguments and the lower and upper bounds describing the predicate. After the `ODCIIndexStart()` call, a series of fetches are performed to obtain row identifiers of rows satisfying the predicate, and finally the `ODCIIndexClose()` is called when the SQL cursor is destroyed.

#### See Also:

- [ODCIIndexClose\(\)](#)
- [ODCIIndexFetch\(\)](#)
- [ODCIIndexStart\(\)](#)

### 9.2.1.4 Execution Model for Index Scan Methods

To implement index scan routines, you must understand how they are invoked and how multiple sets of invocations may be combined.

As an example, consider the query in [Example 9-12](#).

If the optimizer chooses to use the domain indexes on the `resume` columns of both tables, the indextype routines might be invoked in the sequence demonstrated in [Example 9-13](#).

In this example, a single indextype routine is invoked several times for different instances of the `Contains()` operator. It is possible that many operators are being evaluated concurrently through the same indextype routines. A routine that gets all the information it needs through its parameters, such as the `CREATE` routine, does not maintain any state across calls, so evaluating multiple operators concurrently is not a



problem. Other routines that must maintain state across calls, like the `FETCH` routine, must know which row to return next. These routines should maintain state information in the `SELF` parameter that is passed in to each call. The `SELF` parameter, an instance of the implementation type, can be used to store either the entire state or a handle to the cursor-duration memory that stores the state (if the state information is large).

### 9.2.1.5 Filtering Multiple Table Queries with Contains() Operator

#### Example 9-12 Using the Contains() Operator in a Multiple Table Query

```
SELECT * FROM MyEmployees1, MyEmployees2
WHERE
  Contains(MyEmployees1.resume, 'Oracle') =1 AND
  Contains(MyEmployees2.resume, 'UNIX') =1 AND
  MyEmployees1.employee_id = MyEmployees2.employee_id;
```

### 9.2.1.6 Invoking Indextype Routines for the Contains() Operator

#### Example 9-13 Invoking Indextype Routines for the Contains() Operator Query

```
start(ctx1, ...); /* corr. to Contains(MyEmployees1.resume, 'Oracle') */
start(ctx2, ...); /* corr. to Contains(MyEmployees2.resume, 'UNIX') */
fetch(ctx1, ...);
fetch(ctx2, ...);
fetch(ctx1, ...);
...
close(ctx1);
close(ctx2);
```

## 9.2.2 Using Operators Outside the WHERE Clause

Operators that are used outside the `WHERE` clause are evaluated using the functional implementation. To execute the statement in [Example 9-14](#), Oracle scans the `MyEmployees` table and invokes the functional implementation for `Contains()` on each instance of `resume`, passing it the actual value of the `resume`, the text data, in the current row. Note that this function would not make use of any domain indexes built on the `resume` column.

Because functional implementations can make use of domain indexes, consider how to write functions that use domain indexes and how they are invoked by the system.

#### Example 9-14 Using Operators Outside the WHERE Clause

```
SELECT Contains(resume, 'Oracle') FROM MyEmployees;
```

### 9.2.2.1 Creating Index-based Functional Implementations

For many domain-specific operators, such as `Contains()`, the functional implementation has two options:

- If the operator is operating on a column or `OBJECT` attribute that has a domain index, the function can evaluate the operator by looking at the index data rather than the actual argument value.

For example, when `Contains(resume, 'Oracle')` is invoked on a particular row of the `MyEmployees` table, it is easier for the function to look up the text domain index defined on the `resume` column and evaluate the operator based on the row identifier for the row containing the `resume` than to work on the `resume` text data argument.

- If the operator is operating on a column that does not have an appropriate domain index defined on it or if the operator is invoked with literal values (non-columns), the functional implementation evaluates the operator based on the argument values. This is the default behavior for all operator bindings.

To make your operator handle both options, provide a functional implementation that has three arguments in addition to the original arguments to the operator:

- Index context: domain index information and the row identifier of the row on which the operator is being evaluated
- Scan context: a context value to share state with subsequent invocations of the same operator operating on other rows of the table
- Scan flag: indicates whether the current call is the last invocation during which all cleanup operations should be performed

The function `TextContains()` in [Example 9-15](#) provides the index-based functional implementation for the `Contains()` operator.

The `Contains()` operator is bound to the functional implementation, as demonstrated in [Example 9-16](#).

The `WITH INDEX CONTEXT` clause specifies that the functional implementation can make use of any applicable domain indexes. The `SCAN CONTEXT` specifies the data type of the scan context argument, which must be identical to the implementation type of the indextype that supports this operator.

## 9.2.2.2 Implementing the Contains() Operator in Index-Based Functions

### Example 9-15 Implementing the Contains() Operator in Index-Based Functions

```
CREATE FUNCTION TextContains (Text IN VARCHAR2, Key IN VARCHAR2,
indexctx IN ODCIIndexCtx, scanctx IN OUT TextIndexMethods, scanflg IN NUMBER)
RETURN NUMBER AS
BEGIN
.....
END TextContains;
```

## 9.2.2.3 Binding the Contains() Operator to the Functional Implementation

### Example 9-16 Binding the Contains() Operator to the Functional Implementation

```
CREATE OPERATOR Contains
BINDING (VARCHAR2, VARCHAR2) RETURN NUMBER
WITH INDEX CONTEXT, SCAN CONTEXT TextIndexMethods
USING TextContains;
```

## 9.2.2.4 Operator Resolution

Oracle invokes the functional implementation for the operator if the operator appears outside the `WHERE` clause. If the functional implementation is index-based, or defined to use an indextype, the additional index information is passed in as arguments, but only if the operator's first argument is a column or object attribute with a domain index of the appropriate indextype.

For example, in the query `SELECT Contains(resume, 'Oracle & Unix') FROM MyEmployees`, Oracle evaluates the operator `Contains()` using the index-based functional

implementation, passing it the index information about the domain index on the `resume` column instead of the `resume data`.

### 9.2.2.5 Operator Execution

To execute the index-based functional implementation, Oracle sets up the arguments in the following manner:

- The initial set of arguments is identical to those specified by the user for the operator.
- If the first argument is not a column, the `ODCIIndexCtx` attributes are set to `NULL`.
- If the first argument is a column, the `ODCIIndexCtx` attributes are set up as follows.
  - If there is an applicable domain index, the `ODCIIndexInfo` attribute contains information about it; otherwise the attribute is set to `NULL`.
  - The `rowid` attribute holds the row identifier of the row being operated on.
- The scan context is set to `NULL` on the first invocation of the operator. Because it is an `IN/OUT` parameter, the return value from the first invocation is passed in to the second invocation and so on.
- The scan flag is set to `RegularCall` for all normal invocations of the operator. After the last invocation, the functional implementation is invoked one more time, at which time any cleanup actions can be performed. During this call, the scan flag is set to `CleanupCall` and all other arguments except the scan context are set to `NULL`.

When index information is passed in, the implementation can compute the operator value with a domain index lookup using the row identifier as key. The index metadata is used to identify the index structures associated with the domain index. The scan context is typically used to share state with the subsequent invocations of the same operator.

If there is no indextype that supports the operator, or if there is no domain index on the column passed to the operator as its first argument, then the index context argument is null. However, the scan context argument is still available. Thus, the operator can maintain state between invocations even if no index is used by the query.

### 9.2.3 Operators that Return Ancillary Data

In addition to filtering rows, operators in `WHERE` clauses sometimes must return ancillary data. Ancillary data is modeled as one or more operators, each of which has

- A single literal number argument, which ties it to the corresponding primary operator
- A functional implementation with access to state generated by the index scan-based implementation of the primary operator

In the query in [Example 9-17](#), the primary operator, `Contains()`, can be evaluated using an index scan that determines which rows satisfy the predicate, and computes a score value for each row. The functional implementation for the `Score` operator accesses the state generated by the index scan to obtain the score for a given row identified by its row identifier. The literal argument `1` associates the ancillary operator `Score` to the primary operator `Contains()`, which generates the ancillary data.

The functional implementation of an ancillary operator can use either the domain index or the state generated by the primary operator. When invoked, the functional implementation is passed three extra arguments:

- The index context, which contains the domain index information
- The scan context, which provides access to the state generated by the primary operator
- A scan flag to indicate whether the functional implementation is being invoked for the last time

Consider how to define and invoke operators that modeling ancillary data.

#### Example 9-17 Accessing Ancillary Data with the Contains() Operator

```
SELECT Score(1) FROM MyEmployees
WHERE Contains(resume, 'OCI & UNIX', 1) =1;
```

### 9.2.3.1 Operator Bindings that Compute Ancillary Data

An operator binding that computes ancillary data is called a **primary binding**.

[Example 9-18](#) defines a primary binding for the operator `Contains()`.

This definition registers two bindings for `Contains()`:

- `CONTAINS(VARCHAR2, VARCHAR2)`, used when ancillary data is not required
- `CONTAINS(VARCHAR2, VARCHAR2, NUMBER)`, used when ancillary data is required (the `NUMBER` argument associates this binding with the ancillary operator binding)

The two bindings have a single functional implementation, as shown in [Example 9-19](#):

#### Example 9-18 Comparing Ancillary Data with the Contains() Operator

```
CREATE OPERATOR Contains
BINDING (VARCHAR2, VARCHAR2) RETURN NUMBER
WITH INDEX CONTEXT, SCAN CONTEXT TextIndexMethods COMPUTE ANCILLARY DATA
USING TextContains;
```

#### Example 9-19 Implementing Bindings for Computations

```
TextContains(VARCHAR2, VARCHAR2, ODCIIndexCtx, TextIndexMethods, NUMBER).
```

### 9.2.3.2 Operator Bindings That Model Ancillary Data

An operator binding that models ancillary data is called an **ancillary binding**.

Functional implementations for ancillary data operators are similar to index-based functional implementations. When you have defined the function, you bind it to the operator with an additional `ANCILLARY TO` attribute, indicating that the functional implementation must share its state with the primary operator binding.

Note that the functional implementation for the ancillary operator binding must have the same signature as the functional implementation for the primary operator binding.

[Example 9-20](#) demonstrates how to evaluate the ancillary operator inside a `TextScore()` function.

Using the `TextScore()` definition, you could create an ancillary binding, as in [Example 9-21](#).

The `ANCILLARY TO` clause specifies that `Score` shares state with the primary operator binding `CONTAINS(VARCHAR2, VARCHAR2)`.

The ancillary operator binding is invoked with a single literal number argument, such as `Score(1)`, `Score(2)`, and so on.

#### Example 9-20 Evaluating an Ancillary Operator

```
CREATE FUNCTION TextScore (Text IN VARCHAR2, Key IN VARCHAR2,  
    indexctx IN ODCIIndexCtx, scanctx IN OUT TextIndexMethods, scanflg IN NUMBER)  
RETURN NUMBER AS  
BEGIN  
    .....  
END TextScore;
```

#### Example 9-21 Creating an Ancillary Operator Binding

```
CREATE OPERATOR Score  
BINDING (NUMBER) RETURN NUMBER  
ANCILLARY TO Contains(VARCHAR2, VARCHAR2)  
USING TextScore;
```

### 9.2.3.3 Operator Resolution

The operators corresponding to ancillary data are invoked by the user with a single number argument. This number argument must be a literal in both the ancillary operation, and in the primary operator invocation, so that the operator association can be done at query compilation time.

To determine the corresponding primary operator, Oracle matches the number passed to the ancillary operator with the number passed as the last argument to the primary operator. It is an error to find zero or more than one matching primary operator invocation. After the matching primary operator invocation is found,

- The arguments to the primary operator become operands of the ancillary operator.
- The ancillary and primary operator executions are passed the same scan context.

For example, in the [Example 9-17](#) query, the invocation of `Score` is determined to be ancillary to `Contains()` based on the number argument `1`, and the functional implementation for `Score` gets the operands `(resume, 'Oracle&Unix', indexctx, scanctx, scanflg)`, where `scanctx` is shared with the invocation of `Contains()`.

### 9.2.3.4 Operator Execution

Operator execution uses an index scan to process the `Contains()` operator. For each of the rows returned by the `fetch()` call of the index scan, the functional implementation of `Score` is invoked by passing to it the `ODCIIndexCtx` argument, which contains the index information, row identifier, and a handle to the index scan state. The functional implementation can use the handle to the index scan state to compute the score.

# 10

## Using Extensible Optimizer

You can use the Oracle Database extensible optimizer to optimize SQL statement execution. Optimization concepts, statistics, selectivity, cost analysis, the ordering of predicates, and the dependency model of the optimizer are described.

### 10.1 Overview of Query Optimization

**Query Optimization** is the process of choosing the most efficient way to execute a SQL statement. The Extensible Indexing feature discussed in [Defining Operators](#) introduces user-defined access methods.

The extensible optimizer feature allows authors of user-defined functions and indexes to create statistics collection, selectivity, and cost functions that are used by the optimizer in choosing a query plan. The optimizer cost model is extended to integrate information supplied by the user to assess CPU and the I/O cost, where CPU cost is the number of machine instructions used, and I/O cost is the number of data blocks fetched.

Specifically, you can perform the following computations.

- Associate cost functions and default costs with domain indexes (partitioned or non-partitioned), indextypes, packages, and standalone functions. The optimizer can obtain the cost of scanning a single partition of a domain index, multiple domain index partitions, or an entire index.
- Associate selectivity functions and default selectivity with methods of object types, package functions, and standalone functions. The optimizer can estimate user-defined selectivity for a single partition, multiple partitions, or the entire table involved in a query.
- Associate statistics collection functions with domain indexes and columns of tables. The optimizer can collect user-defined statistics at both the partition level and the object level for a domain index or a table.
- Order predicates with functions based on cost.
- Select a user-defined access method (domain index) for a table based on access cost.
- Use the `DBMS_STATS` package to invoke user-defined statistics collection and deletion functions.
- Use new data dictionary views to include information about the statistics collection, cost, or selectivity functions associated with columns, domain indexes, indextypes or functions.
- Add a hint to preserve the order of evaluation for function predicates.

Please note that only the cost-based optimizer has been enhanced; Oracle has not altered the operation of the rule-based optimizer.

The optimizer generates an execution plan for SQL queries and DML statements `SELECT`, `INSERT`, `UPDATE`, or `DELETE`. For simplicity, we describe the generation of an

execution plan in terms of a `SELECT` statement, but the process for DML statements is similar.

An execution plan includes an access method for each table in the `FROM` clause, and an ordering, called the join order, of the tables in the `FROM` clause. System-defined access methods include indexes, hash clusters, and table scans. The optimizer chooses a plan by generating a set of join orders, or permutations, by computing the cost of each, and then by selecting the process with the lowest cost. For each table in the join order, the optimizer computes the cost of each possible access method and join method and chooses the one with the lowest cost. The cost of the join order is the sum of the access method and join method costs. The costs are calculated using algorithms that comprise the cost model. The cost model includes varying level of detail about the physical environment in which the query is executed.

The optimizer uses statistics about the objects referenced in the query to compute the selectivity and costs. The statistics are gathered using the `DBMS_STATS` package. The selectivity of a predicate is the fraction of rows in a table that is chosen by the predicate, and it is a number between 0 and 1.

The Extensible Indexing feature allows users to define new operators, indextypes, and domain indexes. For user-defined operators and domain indexes, the Extensible Optimizer feature enables you to control the three main components used by the optimizer to select an execution plan statistics, selectivity, and cost.

#### See Also:

- *Oracle Database Concepts* for an introduction to optimization
- *Oracle Database 2 Day + Performance Tuning Guide* for information about using hints in SQL statements
- *Oracle Database PL/SQL Packages and Types Reference* for information about `DBMS_STATS`

## 10.1.1 Statistics

Statistics for tables and indexes can be generated by using the `DBMS_STATS` package. In general, the more accurate the statistics, the better the execution plan generated by the optimizer.

### 10.1.1.1 User-Defined Statistics

The Extensible Optimizer feature lets you define *statistics collection* functions for domain indexes, indextypes, data types, individual table columns, and partitions. This means that whenever a domain index is analyzed, a call is made to the user-specified statistics collection function. The database does not know the representation and meaning of the user-collected statistics.

In addition to domain indexes, Oracle supports user-defined statistics collection functions for individual columns of a table, and for user-defined data types. In the former case, whenever a column is analyzed, the user-defined statistics collection function is called to collect statistics in addition to any standard statistics that the database collects. If a statistics collection function exists for a data type, it is called for each column of the table being analyzed that has the required type.

The cost of evaluating a user-defined function depends on the algorithm and the statistical properties of its arguments. It is not practical to store statistics for all possible combinations of columns that could be used as arguments for all functions. Therefore, Oracle maintains only statistics on individual columns. It is also possible that function costs depend on the different statistical properties of each argument. Every column could require statistics for every argument position of every applicable function. Oracle does not support such a proliferation of statistics and cost functions because it would decrease performance.

A user-defined function to drop statistics is required whenever there is a user-defined statistics collection function.

### 10.1.1.2 User-Defined Statistics for Partitioned Objects

When using system-managed local domain indexes, you must implement two methods of the `ODCIStats` interface: `ODCIStatsExchangePartition()`, and `ODCIStatsUpdPartStatistics()`.

## 10.1.2 Selectivity

The optimizer uses statistics to calculate the selectivity of predicates. The selectivity is the fraction of rows in a table or partition that is chosen by the predicate. It is a number between 0 and 1. The selectivity of a predicate is used to estimate the cost of a particular access method; it is also used to determine the optimal join order. A poor choice of join order by the optimizer could result in a very expensive execution plan.

Currently, the optimizer uses a standard algorithm to estimate the selectivity of selection and join predicates. However, the algorithm does not always work well in cases in which predicates contain functions or type methods. In addition, predicates can contain user-defined operators about which the optimizer does not have any information. In that case the optimizer cannot compute an accurate selectivity.

### 10.1.2.1 User-Defined Selectivity

For greater control over the optimizer's selectivity estimation, this feature lets you specify user-defined selectivity functions for predicates containing user-defined operators, standalone functions, package functions, or type methods. The user-defined selectivity function is called by the optimizer whenever it encounters a predicate with one of the forms shown in [Example 10-1](#):

For such cases, users can define selectivity functions associated with `operator(...)`. The arguments to `operator` can be columns, constants, bind variables, or attribute references. When optimizer encounters such a predicate, it calls the user-defined selectivity function and passes the entire predicate as an argument (including the operator, function, or type method and its arguments, the relational operator `relational_operator`, and the constant expression or bind variable). The return value of the user-defined selectivity function must be expressed as a percent, and be between 0 and 100 inclusive; the optimizer ignores values outside this range.

Wherever possible, the optimizer uses user-defined selectivity values. However, this is not possible in the following cases:

- The user-defined selectivity function returns an invalid value (less than 0 or greater than 100).



- There is no user-defined selectivity function defined for the operator, function, or method in the predicate.
- The predicate does not have one of the forms listed in [Example 10-1](#); it may also be of the form `operator(...) + 3 relational_operator constant`.

In each of these cases, the optimizer uses heuristics to estimate the selectivity.

#### Example 10-1 Three Predicate Forms that Trigger a Call to the Optimizer

```
operator(...) relational_operator constant
constant relational_operator operator(...)
operator(...) LIKE constant
```

where

- `operator(...)` is a user-defined operator, standalone function, package function, or type method,
- `relational_operator` is one of {<, <=, =, >=, >}, and
- `constant` is a constant value expression or bind variable.

## 10.1.3 Cost

The optimizer estimates the cost of various access paths to choose an optimal plan. For example, it computes the CPU and I/O cost of using an index and a full table scan to choose between the two. However the optimizer does not know the internal storage structure of domain indexes, and so it cannot compute a good estimate of the cost of a domain index.

### 10.1.3.1 User-Defined Cost

For greater flexibility, the cost model has been extended to let you define costs for domain indexes, index partitions, and user-defined standalone functions, package functions, and type methods. The user-defined costs can be in the form of default costs that the optimizer looks up, or they can be full-fledged cost functions which the optimizer calls to compute the cost.

Like user-defined selectivity statistics, user-defined cost statistics are optional. If no user-defined cost is available, the optimizer uses heuristics to compute an estimate. However, in the absence of sufficient useful information about the storage structures in user-defined domain indexes and functions, such estimates can be very inaccurate and result in the choice of a sub-optimal execution plan.

User-defined cost functions for domain indexes are called by the optimizer only if a domain index is a valid access path for a user-defined operator. User-defined cost functions for functions, methods and domain indexes are only called when a predicate has one of the forms outlined in [Example 10-1](#), which is identical to the conditions for user-defined selectivity functions.

User-defined cost functions can return three cost values, each value representing the cost of a *single* execution of a function or domain index implementation:

- CPU — the number of machine cycles executed by the function or domain index implementation. This does not include the overhead of invoking the function.

- I/O — the number of data blocks read by the function or domain index implementation. For a domain index, this does not include accesses to the Oracle table. The multiblock I/O factor is not passed to the user-defined cost functions.
- NETWORK — the number of data blocks transmitted. This is valid for distributed queries, functions, and domain index implementations. For Oracle, this cost component is not used and is therefore ignored; however, the user is required to stipulate a value so ensure backward compatibility.

The optimizer computes a composite cost from these cost values.

The package `DBMS_ODCI` contains a function `estimate_cpu_units` to help get the CPU and I/O cost from input consisting of the elapsed time of a user function.

`estimate_cpu_units` measures CPU units by multiplying the elapsed time by the processor speed of the machine and returns the approximate number of CPU instructions associated with the user function. For a multiprocessor machine, `estimate_cpu_units` considers the speed of a single processor.

The cost of a query is a function of the cost values. The settings of optimizer initialization parameters determine which cost to minimize. If `optimizer_mode` is `first_rows`, the resource cost of returning a single row is minimized, and the optimizer mode is passed to user-defined cost functions. Otherwise, the resource cost of returning all rows is minimized.

## 10.2 Defining Statistics, Selectivity, and Cost Functions

You can compute and store user-defined statistics for domain indexes and columns. User-defined selectivity and cost functions for functions and domain indexes can use both standard and user-defined statistics in their computation. The internal representation of these statistics need not be known to Oracle, but you must provide methods for their collection. You are solely responsible for defining the representation of such statistics and for maintaining them. Note that user-collected statistics are used only by user-defined selectivity and cost functions; the optimizer uses only its standard statistics.

User-defined statistics collection, selectivity, and cost functions must be defined in a user-defined type. Depending on the functionality you want it to support, this type must implement as methods some or all of the functions defined in the system interface `ODCIStats`, Oracle Data Cartridge Interface Statistics, in [Extensible Optimizer Interface](#).

[Example 10-2](#) shows a type definition (or the outline of one) that implements all the functions in the `ODCIStats` interface.

The object type that you define, referred to as a **statistics type**, need not implement all the functions from `ODCIStats`. User-defined statistics collection, selectivity, and cost functions are optional, so a statistics type may contain only a subset of the functions in `ODCIStats`. [Table 10-1](#) summarizes the type methods and default statistics associated with different kinds of schema objects.

**Table 10-1 Statistics Methods and Default Statistics for Various Schema Objects**

ASSOCIATE STATISTICS	Statistics Type Methods Used	Default Statistics
column	<code>ODCIStatsCollect()</code> , <code>ODCIStatsDelete()</code>	

**Table 10-1 (Cont.) Statistics Methods and Default Statistics for Various Schema Objects**

ASSOCIATE STATISTICS	Statistics Type Methods Used	Default Statistics
object type	<a href="#">ODCIStatsCollect()</a> , <a href="#">ODCIStatsDelete()</a> , <a href="#">ODCIStatsFunctionCost()</a> , <a href="#">ODCIStatsSelectivity()</a>	cost, selectivity
function	<a href="#">ODCIStatsFunctionCost()</a> , <a href="#">ODCIStatsSelectivity()</a>	cost, selectivity
package	<a href="#">ODCIStatsFunctionCost()</a> , <a href="#">ODCIStatsSelectivity()</a>	cost, selectivity
index	<a href="#">ODCIStatsCollect()</a> , <a href="#">ODCIStatsDelete()</a> , <a href="#">ODCIStatsIndexCost()</a>	cost
indextype	<a href="#">ODCIStatsCollect()</a> , <a href="#">ODCIStatsDelete()</a> , <a href="#">ODCIStatsIndexCost()</a> , <a href="#">ODCIStatsUpdPartStatistics()</a> , <a href="#">ODCIStatsExchangePartition()</a>	cost

The types of the parameters of statistics type methods are system-defined ODCI data types. These are described in [Extensible Optimizer Interface](#).

The selectivity and cost functions must not change any database or package state. Consequently, no SQL DDL or DML operations are permitted in the selectivity and cost functions. If such operations are present, the functions are not called by the optimizer.

## 10.2.1 Defining a Statistics Type

### Example 10-2 Defining a Statistics Type

```
CREATE TYPE my_statistics AS OBJECT (

  -- Function to get current interface
  FUNCTION ODCIGetInterfaces(ifclist OUT ODCIObjectList) RETURN NUMBER,

  -- User-defined statistics functions
  FUNCTION ODCIStatsCollect(col ODCIColInfo, options ODCIStatsOptions,
    statistics OUT RAW, env ODCIEnv) RETURN NUMBER,
  FUNCTION ODCIStatsCollect(ia ODCIIndexInfo, options ODCIStatsOptions,
    statistics OUT RAW, env ODCIEnv) RETURN NUMBER,
  FUNCTION ODCIStatsDelete(col ODCIColInfo, statistics OUT RAW, env ODCIEnv)
    RETURN NUMBER,
  FUNCTION ODCIStatsDelete(ia ODCIIndexInfo, statistics OUT RAW, env ODCIEnv)
    RETURN NUMBER,

  -- User-defined statistics functions for local domain index
  FUNCTION ODCIStatsUpdPartStatistics(ia ODCIIndexInfo, palistODCIPartInfoList,
    env ODCIEnv) RETURN NUMBER;
  FUNCTION ODCIStatsExchangePartition(ia ODCIIndexInfo, ial ODCIIndexInfo,
    env ODCIEnv) RETURN NUMBER;

  -- User-defined selectivity function
  FUNCTION ODCIStatsSelectivity(pred ODCIPredInfo, sel OUT NUMBER, args
    ODCIArgDescList, start <function_return_type>,
    stop <function_return_type>, <list of function arguments>,
    env ODCIEnv) RETURN NUMBER,
```

```
-- User-defined cost function for functions and type methods
FUNCTION ODCIStatsFunctionCost(func ODCIFuncInfo, cost OUT ODCICost,
    args ODCIArgDescList, <list of function arguments>) RETURN NUMBER,

-- User-defined cost function for domain indexes
FUNCTION ODCIStatsIndexCost(ia ODCIIndexInfo, sel NUMBER,
    cost OUT ODCICost, qi ODCIQueryInfo, pred ODCIPredInfo,
    args ODCIArgDescList, start <operator_return_type>,
    stop <operator_return_type>, <list of operator value arguments>,
    env ODCIEnv) RETURN NUMBER
)
```

## 10.2.2 User-Defined Statistics Functions

There are two user-defined statistics collection functions, one for collecting statistics and the other for deleting them.

The first, `ODCIStatsCollect()`, is used to collect user-defined statistics; its interface depends on whether a column or domain index is being analyzed. It is called when analyzing a column of a table or a domain index and takes two parameters:

- `col` for the column being analyzed, or `ia` for the domain index being analyzed;
- `options` for options specified in the `DBMS_STATS` package.

As mentioned, the database does not interpret statistics collected by `ODCIStatsCollect()`. For system-managed domain index statistics, you don't return the statistics collected by `ODCIStatsCollect()`. You should store these statistics in a user-managed format, as described in [Generating Statistics for System-Managed Domain Indexes](#), and illustrated in [Figure 10-1](#), [Figure 10-2](#), and [Figure 10-3](#).

User-collected statistics are deleted by calling the `ODCIStatsDelete()` function whose interface depends on whether the statistics for a column or domain index are being dropped. It takes a single parameter: `col`, for the column whose user-defined statistics must be deleted, or `ia`, for the domain index whose statistics are to be deleted.

If a user-defined `ODCIStatsCollect()` function is present in a statistics type, the corresponding `ODCIStatsDelete()` function must also be present.

The return values of the `ODCIStatsCollect()` and `ODCIStatsDelete()` functions must be `Success`, `Error`, or `Warning`; these return values are defined in a system package `ODCIConst`.

### See Also:

- [ODCIStatsCollect\(\)](#)
- [ODCIStatsDelete\(\)](#)
- 

## 10.2.3 User-Defined Selectivity Functions

User-defined selectivity functions are used only for predicate forms listed in [Example 10-1](#).

A user-defined selectivity function `ODCIStatsSelectivity()` takes five sets of input parameters that describe the predicate:

- The `pred` parameter describes the function `operator` and the relational operator `relational_operator`.
- The `args` parameter describes the start and stop values (that is, `<constant>`) of the function and the actual arguments to the function (`operator()`).
- The `start` parameter, whose data type is identical to that of the function's return value, describes the start value of the function.
- The `stop` parameter, whose data type is identical to that of the function's return value, describes the stop value of the function.
- A list of function arguments whose number, position, and type must match the arguments of the function `operator`.

The computed selectivity is returned in the output parameter `sel` as a number between 0 and 100 (inclusive) that represents a percentage. The optimizer ignores numbers less than 0 or greater than 100 as invalid values. If the computed selectivity is less than 0.5%, a value of 0 may be returned in the output parameter `sel`. A selectivity of 0 does not mean that the predicate will be removed.

The return value of the `ODCIStatsSelectivity()` function must be one of `Success`, `Error`, or `Warning`.

As an example, consider a function `myFunction`, as defined in [Example 10-3](#).

A user-defined selectivity function `ODCIStatsSelectivity()` is detailed in [Extensible Optimizer Interface](#).

If `myFunction()` is called using literal arguments, such as `myFunction(2, 'TEST') > 5`, then the selectivity function is called as outlined in [Example 10-4](#).

If, on the other hand, `myFunction()` is called with some non-literals arguments, such as `myFunction(Test_tab.col_a, 'TEST') > 5`, where `col_a` is a column in table `Test_tab`, then the selectivity function is called as outlined in [Example 10-5](#).

In summary, the start, stop, and function argument values are passed to the selectivity function only if they are literals; otherwise they are `NULL`. `ODCIArgDescList` describes all the arguments that follow it.

### Example 10-3 Defining a User-Defined Function

```
myFunction (a NUMBER, b VARCHAR2(10)) return NUMBER
```

### Example 10-4 Calling a Selectivity Function Using Literal Arguments

```
ODCIStatsSelectivity(ODCIPredInfo_constructor, sel,
  ODCIArgDescList_constructor, 5, NULL, 2, 'TEST', ODCIEnv_flag)
```

### Example 10-5 Calling a Selectivity Function Using Non-Literal Arguments

```
ODCIStatsSelectivity(ODCIPredInfo_constructor, sel,
  ODCIArgDescList_constructor, 5, NULL, NULL, 'TEST', ODCIEnv_flag)
```

 See Also:

- [ODCIStatsSelectivity\(\)](#)
- [ODCIArgDescList](#)

## 10.2.4 User-Defined Cost Functions for Functions

User-defined cost functions are only used for predicate forms listed in [Example 10-1](#).

You can define a function, `ODCIStatsFunctionCost()`, for computing the cost of standalone functions, package functions, or type methods. This function takes three sets of input parameters describing the predicate:

- The `func` parameter describes the function operator.
- The `args` parameter describes the actual arguments to the function operator.
- A list of function arguments whose number, position, and type must match the arguments of the function operator.

The `ODCIStatsFunctionCost()` function returns its computed cost in the `cost` parameter. The returned cost can have two components, a CPU cost and an I/O cost, which are combined by the optimizer to compute a composite cost. The costs returned by user-defined cost functions must be positive whole numbers. Invalid values are ignored by the optimizer.

The return value of the `ODCIStatsFunctionCost()` function must be one of `Success`, `Error`, or `Warning`.

Consider a `myFunction()`, defined in [Example 10-3](#).

A user-defined cost function `ODCIStatsFunctionCost()` is detailed in [Extensible Optimizer Interface](#).

If `myFunction()` is called using literal arguments, such as `myFunction(2, 'TEST') > 5`, where `col_a` is a column in table `Test_tab`, then the cost function is called as out lined in [Example 10-6](#).

If, on the other hand, `myFunction()` is called with non-literal arguments, such as `myFunction(Test_tab.col_a, 'TEST') > 5`, where `col_a` is a column in table `Test_tab`, then the cost function is called as out lined in [Example 10-7](#).

In summary, function argument values are passed to the cost function only if they are literals; otherwise, they are `NULL`. [ODCIArgDescList](#) describes all the arguments that follow it.

### Example 10-6 Calling a Cost Function Using Literal Arguments

```
ODCIStatsFunctionCost(ODCIFuncInfo_constructor, cost,
  ODCIArgDescList_constructor, 2, 'TEST', ODCIEnv_flag)
```

### Example 10-7 Calling a Cost Function Using Non-Literal Arguments

```
ODCIStatsFunctionCost(ODCIFuncInfo_constructor, cost,
  ODCIArgDescList_constructor, NULL, 'TEST', ODCIEnv_flag)
```

 **See Also:**

- [ODCIStatsFunctionCost\(\)](#)

## 10.2.5 User-Defined Cost Functions for Domain Indexes

User-defined cost functions for domain indexes are used for the same type of predicates mentioned previously, except that `operator` must be a user-defined operator for which a valid domain index access path exists.

The `ODCIStatsIndexCost()` function takes these sets of parameters:

- `ia` describing the domain index
- `sel` representing the user-computed selectivity of the predicate
- `cost` giving the computed cost
- `qi` containing additional information about the query
- `pred` describing the predicate
- `args` describing the start and stop values (that is, `<constant>`) of the operator and the actual arguments to the operator `operator`
- `start`, whose data type is identical to that of the operator's return value, describing the start value of the operator
- `stop` whose data type is identical to that of the operator's return value, describing the stop value of the operator
- a list of operator value arguments whose number, position, and type must match the arguments of the operator `operator`. The value arguments of an operator are the arguments excluding the first argument.
- `env`, an environment flag set by the server to indicate which call is being made in cases where multiple calls are made to the same routine. The flag is reserved for future use; currently it is always set to 0.

The computed cost of the domain index is returned in the output parameter, `cost`.

`ODCIStatsIndexCost()` returns Success, Error OR Warning.

Consider an operator defined in [Example 10-8](#), which returns 1 or 0 depending on whether or not the string `b_string` is contained in the string `a_string`. Further, assume that the operator is implemented by a domain index.

A user-defined index cost function `ODCIStatsIndexCost()` is detailed in [Extensible Optimizer Interface](#).

If `contains()` is called using non-literal arguments, such as `Contains(Test_tab.col_c, 'TEST') <= 1`, then the index cost function is called as outlined in [Example 10-9](#).

Note that the first argument, `a_string`, of `Contains` does not appear as a parameter of `ODCIStatsIndexCost()`. This is because the first argument to an operator must be a column for the domain index to be used, and this column information is passed in through the `ODCIIndexInfo` parameter. Only the operator arguments after the first (the value arguments) must appear as parameters to the `ODCIStatsIndexCost()` function.

In summary, the start, stop, and operator argument values are passed to the index cost function only if they are literals; otherwise they are `NULL`. [ODCIArgDescList](#) describes all the arguments that follow it.

#### Example 10-8 Defining an Operator

```
Contains(a_string VARCHAR2(2000), b_string VARCHAR2(10))
```

#### Example 10-9 Calling an Index Cost Function Using Non-Literal Arguments

```
ODCIStatsIndexCost(ODCIIndexInfo_constructor, sel, cost,  
ODCIQueryInfo_constructor, ODCIPredInfo_constructor,  
ODCIArgDescList_constructor, NULL, 1, 'TEST', ODCIEnv_flag)
```

#### See Also:

[ODCIStatsIndexCost\(\)](#)

## 10.2.6 Generating Statistics for System-Managed Domain Indexes

If you choose the system-managed approach to maintain domain indexes and must associate a statistics type with the domain index or the indextype, then the statistics type must also be managed by the system.

Statistics may be collected when issuing an `ODCIStatsCollect()` call for a system-managed domain index. For a non-partitioned index, the statistics may be stored with the index storage table, as a separate table, or in a data cartridge metadata table with index name qualified rows.

For local partitioned domain indexes, there are three options for storing statistics. All use the `ODCIStatsUpdPartStatistics()` method during a partition maintenance operation in the following ways. Please note that in all the following examples, no DDLs are executed inside the `ODCIStatsUpdPartStatistics()` call, and only DML and query instructions are allowed in the implementation of `ODCIStatsUpdPartStatistics()`.

#### See Also:

- [ODCIStatsCollect\(\)](#)
- [ODCIStatsUpdPartStatistics\(\)](#)

### 10.2.6.1 Index-Partition Statistics Storage in an Index Table

The system calls the [ODCIStatsUpdPartStatistics\(\)](#) method. If the statistics are stored with the indexed data in the index storage (system-partitioned) tables, as illustrated in [Figure 10-1](#). The method can optionally maintain any statistics-related partition metadata, or be a null operation. The server deletes or drops the statistics for the affected partitions along with the index data specific to these partitions.



**Figure 10-1 Storing Index-Specific Statistics with Index Tables**

Partition	IndexData (value)	Statistics (frequency)
P1	25	10
	35	5
P2	57	22
	76	10
	99	5
P3	120	15
	150	5

### 10.2.6.2 Index-Partition Statistics Storage in a Separate Table

If the statistics are stored in separate system-partitioned tables, as illustrated in [Figure 10-2](#), the server tracks the creation of these system partitioned tables of store statistics during an `ODCIStatsCollect()` call. These tables are maintained by the server in the same manner as for index storage tables.

**Figure 10-2 Storing Index-Specific Statistics in a Separate Table**

Partition	Statistics
P1	StatsP1_1
	StatsP1_2
P2	StatsP2_1
	StatsP2_2
	StatsP2_3
P3	StatsP3_1
	StatsP3_2

### 10.2.6.3 Index-Partition Statistics Storage in a Common Table

If the statistics are stored in a non-partitioned table as either schema-name, index-name, or partition-name qualified rows, as illustrated in [Figure 10-3](#), then you have to maintain the partition-level statistics with a call to `ODCIStatsUpdPartStatistics()`. The server does not perform any operation on these tables.

**Figure 10-3 Storing Index-Partition Statistics in a Common Table**

Schema	Index	IndexPartition	UserdefinedStatistics
U1	I1	IP1	Statistics1
U1	I1	IP2	Statistics2
U2	I2	IP1	Statistics3
U2	I2	IP2	Statistics4
U2	I2	IP3	Statistics5

## 10.3 Using User-Defined Statistics, Selectivity, and Cost

Statistics types act as interfaces for user-defined functions that influence the choice of an execution plan by the optimizer. However, for the optimizer to be able to use a statistics type, it requires a mechanism to bind the statistics type to a database object such as a column, a standalone function, an object type, an index, an indextype or a package. You cannot associate a statistics type with a partition of a table or a partition of a domain index. The `ASSOCIATE STATISTICS` command creates this association.

### 10.3.1 User-Defined Statistics

User-defined statistics functions are relevant for columns that use both standard SQL data types and object types, and for domain indexes. The functions `ODCIStatsSelectivity()`, `ODCIStatsFunctionCost()`, and `ODCIStatsIndexCost()` are not used for user-defined statistics, so statistics types used only to collect user-defined statistics need not implement these functions.

Users could create their own tables. This approach requires that privileges on these tables be administered properly, backup and restoration of these tables be done along with other dictionary tables, and point-in-time recovery considerations be resolved.

#### 10.3.1.1 Column Statistics

Consider a table `Test_tab`, defined as in [Example 10-10](#), where `typ1` is an object type.

Suppose that `stat` is a statistics type that implements `ODCIStatsCollect()` and `ODCIStatsDelete()` functions. User-defined statistics are collected by the `DBMS_STATS` package for the column `col_b` if we bind a statistics type with the column, as demonstrated in [Example 10-11](#):

A list of columns can be associated with the statistics type `stat`. Note that Oracle supports only associations with top-level columns, not attributes of object types; if you wish, the `ODCIStatsCollect()` function can collect individual attribute statistics by traversing the column.

Another way to collect user-defined statistics is to declare an association with a data type, as in [Example 10-12](#), which declares `stat_typ1` as the statistics type for the type `typ1`. When the table `Test_tab` is analyzed with this association, user-defined statistics are collected for the column `col_b` using the `ODCIStatsCollect()` function of statistics type `stat_typ1`.

Individual column associations always have precedence over associations with types. Thus, in the preceding example, if both `ASSOCIATE STATISTICS` commands are issued, `DBMS_STATS` would use the statistics type `stat` (and *not* `stat_ttyp1`) to collect user-defined statistics for column `col_b`. It is also important to note that standard statistics, if possible, are collected along with user-defined statistics.

User-defined statistics are deleted using the `ODCIStatsDelete()` function from the same statistics type that was used to collect the statistics.

Associations defined by the `ASSOCIATE STATISTICS` command are stored in a dictionary table called `ASSOCIATION$`.

Only user-defined data types can have statistics types associated with them; you cannot declare associations for standard SQL data types.

#### Example 10-10 Creating a Table with an Object Type Column

```
CREATE TABLE Test_tab (
  col_a    NUMBER,
  col_b    typ1,
  col_c    VARCHAR2(2000)
)
```

#### Example 10-11 Associating Statistics with Columns for User-Defined Statistics

```
ASSOCIATE STATISTICS WITH COLUMNS Test_tab.col_b USING stat
```

#### Example 10-12 Associating Statistics with Data Types for User-Defined Statistics

```
ASSOCIATE STATISTICS WITH TYPES typ1 USING stat_ttyp1
```

### 10.3.1.2 Implementing Domain Index Statistics

A domain index has an `indextype`. A statistics type for a system-managed domain index is defined by associating it only with its `indextype`. [Example 10-13](#) demonstrates how to create an `indextype`, an index, and an operator on the table `Test_tab` from [Example 10-10](#):

Here, `indtype` is the `indextype`, `userOp` is a user-defined operator supported by `indtype`, `userOp_func` is the functional implementation of `userOp`, and `imptype` is the implementation type of the `indextype` `indtype`.

A statistics type `stat_indtype` can be associated with the system-managed `indextype`, as demonstrated in [Example 10-14](#). When the domain index `Test_indx` that has an `indextype` `indtype` is analyzed, user-defined statistics for the index are collected by calling the `ODCIStatsCollect()` function of `stat_indtype`.

To drop index statistics, use the `ODCIStatsDelete()` method which is defined for the same statistics type that defined the earlier `ODCIStatsCollect()` method.

#### Example 10-13 Creating an Indextype, an Index and an Operator for User-Defined Statistics

```
CREATE INDEXTYPE indtype
FOR userOp(NUMBER)
USING imptype WITH SYSTEM MANAGED STORAGE TABLES;

CREATE INDEX Test_indx ON Test_tab(col_a)
INDEXTYPE IS indtype PARAMETERS('example');
```

```
CREATE OPERATOR userOp BINDING (NUMBER) RETURN NUMBER
USING userOp_func;
```

#### Example 10-14 Associating Statistics with System-Managed Indextypes

```
ASSOCIATE STATISTICS WITH INDEXTYPES indtype USING stat_indtype
WITH SYSTEM MANAGED STORAGE TABLES
```

## 10.3.2 User-Defined Selectivity

The optimizer uses selectivity functions to compute the selectivity of predicates in a query. The predicates must have one of the appropriate forms and can contain user-defined operators, standalone functions, package functions, or type methods.

### 10.3.2.1 User-Defined Operators

Suppose that the association in [Example 10-15](#) is declared. If the optimizer encounters the `userOp(Test_tab.col_a) = 1` predicate, it calls the `ODCIStatsSelectivity()` function (if present) in the statistics type `stat_userOp_func` that is associated with the functional implementation of the `userOp_func` of the `userOp` operator.

#### Example 10-15 Associating Statistics with User-Defined Operators

```
ASSOCIATE STATISTICS WITH FUNCTIONS userOp_func USING stat_userOp_func
```

### 10.3.2.2 Standalone Functions

If the association in [Example 10-16](#) is declared for a standalone function `myFunction`, then the optimizer calls the `ODCIStatsSelectivity()` function (if present) in the statistics type `stat_myFunction` for the `myFunction(Test_tab.col_a, 'TEST') = 1` predicate.

#### Example 10-16 Associating Statistics with Standalone Functions

```
ASSOCIATE STATISTICS WITH FUNCTIONS myFunction USING stat_MyFunction
```

### 10.3.2.3 Package Functions

If the association in [Example 10-17](#) is declared for a package `Demo_pack`, then the optimizer calls the `ODCIStatsSelectivity()` function (if present) in the statistics type `stat_Demo_pack` for the `Demo_pack.myDemoPackFunction(Test_tab.col_a, 'TEST') = 1` predicate, where `myDemoPackFunction` is a function in `Demo_pack`.

#### Example 10-17 Associating Statistics with Package Functions

```
ASSOCIATE STATISTICS WITH PACKAGES Demo_pack USING stat_Demo_pack
```

### 10.3.2.4 Type Methods

If the association in [Example 10-18](#) is declared for a type `Example_typ`, then the optimizer calls the `ODCIStatsSelectivity()` function (if present) in the statistics type `stat_Example_typ` for the `myExampleTypMethod(Test_tab.col_b) = 1` predicate, where `myExampleTypMethod` is a method in `Example_typ`.

#### Example 10-18 Associating Statistics with Type Methods

```
ASSOCIATE STATISTICS WITH TYPES Example_typ USING stat_Example_typ
```

### 10.3.2.5 Default Selectivity

An alternative to selectivity functions is user-defined *default selectivity*. The default selectivity is a value between 0 and 100%; the optimizer looks it up instead of calling a selectivity function. Default selectivities can be used for predicates with user-defined operators, standalone functions, package functions, or type methods.

The association in [Example 10-19](#) declares that the `myFunction(Test_tab.col_a) = 1` predicate always has a selectivity of 20% (or 0.2), regardless of the parameters of `myFunction`, the comparison operator `=`, or the constant 1. The optimizer uses this default selectivity instead of calling a selectivity function.

An association can be declared using either a statistics type or a default selectivity, but not both. Thus, the following statement is illegal:

```
ASSOCIATE STATISTICS WITH FUNCTIONS myFunction USING stat_myFunction
    DEFAULT SELECTIVITY 20
```

Other examples of default selectivity declarations include:

```
ASSOCIATE STATISTICS WITH PACKAGES Demo_pack DEFAULT SELECTIVITY 20
ASSOCIATE STATISTICS WITH TYPES Example_typ DEFAULT SELECTIVITY 20
```

#### **Example 10-19 Associating Statistics with Default Selectivity**

```
ASSOCIATE STATISTICS WITH FUNCTIONS myFunction DEFAULT SELECTIVITY 20
```

### 10.3.3 User-Defined Cost

The optimizer uses user-defined cost functions to compute the cost of predicates in a query. The predicates must have one of the forms listed earlier and can contain user-defined operators, standalone functions, package functions, or type methods. In addition, user-defined cost functions are also used to compute the cost of domain indexes.

#### 10.3.3.1 User-Defined Operators

If the association in [Example 10-20](#) is declared, consider the `userOp(Test_tab.col_a) = 1` predicate. If the optimizer evaluates the domain index `Test_indx` with an `indtype` `indtype` that implements `userOp`, it calls the `ODCIStatsIndexCost()` method (if present) in the statistics type `stat_indtype`. If the domain index is not used, however, the optimizer calls the `ODCIStatsFunctionCost()` (if present) in the statistics type `stat_userOp` to compute the cost of the functional implementation of the operator `userOp`.

#### **Example 10-20 Associating Statistics with User-Defined Operators**

```
ASSOCIATE STATISTICS WITH INDEXTYPES indtype USING stat_indtype
    WITH SYSTEM MANAGED STORAGE TABLES
ASSOCIATE STATISTICS WITH FUNCTIONS userOp USING stat_userOp_func
```

#### 10.3.3.2 Standalone Functions

If the association in [Example 10-21](#) is declared for a standalone function `myFunction`, then the optimizer calls the `ODCIStatsFunctionCost()` function (if present) in the

statistics type `stat_myFunction` for the `myFunction(Test_tab.col_a, 'TEST') = 1` predicate.

User-defined function costs do not influence the choice of access methods; they are only used for ordering predicates, described in [Extensible Optimizer Interface](#).

#### Example 10-21 Associating Statistics with Standalone Functions

```
ASSOCIATE STATISTICS WITH FUNCTIONS myFunction USING stat_myFunction;
```

### 10.3.3.3 Package Functions

If the association in [Example 10-22](#) is declared for a package `Demo_pack`, then the optimizer calls the `ODCIStatsFunctionCost()` function, if present, in the statistics type `stat_Demo_pack` for the `Demo_pack.myDemoPackFunction(Test_tab.col_a) = 1` predicate, where `myDemoPackFunction` is a function in `Demo_pack`.

#### Example 10-22 Associating Statistics with Package Functions

```
ASSOCIATE STATISTICS WITH PACKAGES Demo_pack USING stat_Demo_pack;
```

### 10.3.3.4 Type Methods

If the association is declared, as in [Example 10-23](#), for a type `Example_typ`, then the optimizer calls the `ODCIStatsFunctionCost()` function, if present, in the statistics type `stat_Example_typ` for the `myExampleTypMethod(Test_tab.col_b) = 1` predicate, where `myExampleTypMethod` is a method in `Example_typ`.

#### Example 10-23 Associating Statistics with Type Methods

```
ASSOCIATE STATISTICS WITH TYPES Example_typ USING stat_Example_typ;
```

### 10.3.3.5 Default Cost

Like default selectivity, default costs can be used for predicates with user-defined operators, standalone functions, package functions, or type methods. The command in [Example 10-24](#) declares that using the domain index `Test_indx` to implement the `userOp(Test_tab.col_a) = 1` predicate always has a CPU cost of 100, an I/O cost of 5, and a network cost of 0 (the network cost is ignored in Oracle), regardless of the parameters of `userOp`, the comparison operator "=", or the constant "1". The optimizer uses this default cost instead of calling the `ODCIStatsIndexCost()` function.

You can declare an association using either a statistics type or a default cost but not both. Thus, the following statement is illegal:

```
ASSOCIATE STATISTICS WITH INDEXES Test_indx USING stat_Test_indx
  DEFAULT COST (100, 5, 0)
```

The following are some more examples of default cost declarations:

```
ASSOCIATE STATISTICS WITH FUNCTIONS myFunction DEFAULT COST (100, 5, 0)
ASSOCIATE STATISTICS WITH PACKAGES Demo_pack DEFAULT COST (100, 5, 0)
ASSOCIATE STATISTICS WITH TYPES Example_typ DEFAULT COST (100, 5, 0)
ASSOCIATE STATISTICS WITH INDEXTYPES indtype DEFAULT COST (100, 5, 0)
```

#### Example 10-24 Associating Statistics with Default Cost

```
ASSOCIATE STATISTICS WITH INDEXES Test_indx DEFAULT COST (100, 5, 0);
```

## 10.3.4 Declaring a NULL Association for an Index or Column

An association of a statistics type defined for an indextype or object type is inherited by index instances of that indextype and by columns of that object type. An inherited association can be overridden by explicitly defining a different association for an index instance or column, but there may be occasions when you would prefer an index or column not to have any association at all. For example, for a particular query the benefit of a better plan may not outweigh the additional compilation time incurred by invoking the cost or selectivity functions. For cases like this, you can use the `ASSOCIATE` command to declare a `NULL` association for a column or index, as in [Example 10-25](#).

If the `NULL` association is specified, the schema object does not inherit any statistics type from the column type or the indextype. A `NULL` association also precludes default values.

### Example 10-25 Declaring NULL Statistics Associations for Columns and Indexes

```
ASSOCIATE STATISTICS WITH COLUMNS columns NULL;
ASSOCIATE STATISTICS WITH INDEXES indexes NULL;
```

## 10.3.5 How DDL Operations Affect Statistics

Partition-level and schema object-level aggregate statistics are affected by DDL operations in the same way as standard statistics. [Table 10-2](#) summarizes the effects.

**Table 10-2 Effects of DDL on Partition and Global Statistics**

Operation	Effect on Partition Statistics	Effect on Global Statistics
ADD PARTITION	None	No Action
COALESCE PARTITION	Statistics deleted	Statistics recalculated (if <code>_minimal_stats_aggregation</code> is <code>FALSE</code> , otherwise, no effect)
DROP PARTITION	Statistics deleted	Statistics recalculated (if <code>_minimal_stats_aggregation</code> is <code>FALSE</code> , otherwise no effect)
SPLIT PARTITION	Statistics deleted	None
MERGE PARTITION	Statistics deleted	None
TRUNCATE PARTITION	Statistics deleted	None
EXCHANGE PARTITION	Statistics deleted	Statistics recalculated (if <code>_minimal_stats_aggregation</code> is <code>FALSE</code> , otherwise no effect)
REBUILD PARTITION	None	None

**Table 10-2 (Cont.) Effects of DDL on Partition and Global Statistics**

Operation	Effect on Partition Statistics	Effect on Global Statistics
MOVE PARTITION	None	None
RENAME PARTITION	None	None

If an existing partition is exchanged, or dropped with an `ALTER TABLE DROP PARTITION` statement, and the `_minimal_stats_aggregation` parameter is set to `FALSE`, the statistics for that partition are deleted, and the aggregate statistics of the table or index are recalculated.

## 10.4 Predicate Ordering

In the absence of an `ORDERED_PREDICATES` hint, predicates (except those used for index keys) are evaluated in the order specified by the following rules:

- Predicates without any user-defined functions, type methods, or subqueries are evaluated first, in the order specified in the `WHERE` clause.
- Predicates with user-defined functions and type methods which have user-computed costs are evaluated in increasing order of their cost.
- Predicates with user-defined functions and type methods that have no user-computed cost are evaluated next, in the order specified in the `WHERE` clause.
- Predicates not specified in the `WHERE` clause (for example, predicates transitively generated by the optimizer) are evaluated next.
- Predicates with subqueries are evaluated last in the order specified in the `WHERE` clause.

## 10.5 Dependency Model

The dependency model reflects the actions that are taken when you issue any of the SQL commands described in [Table 10-3](#).

**Table 10-3 Dependency Model for DDLs**

Command	Action
<code>DROP statistics_type</code>	If an association is defined with <code>statistics_type</code> , the command fails, otherwise the type is dropped.
<code>DROP statistics_type FORCE</code>	Calls <code>DISASSOCIATE FORCE</code> for all objects associated with the <code>statistics_type</code> ; drops <code>statistics_type</code> .
<code>DROP object</code>	Calls <code>DISASSOCIATE</code> , drops <code>object_type</code> if <code>DISASSOCIATE</code> succeeds.



**Table 10-3 (Cont.) Dependency Model for DDLs**

Command	Action
ALTER TABLE DROP COLUMN	If association is present for the column, this calls <code>DISASSOCIATE FORCE with column</code> ; if no entry in <code>ASSOCIATION\$</code> but there are entries in type <code>USATS\$</code> , then <code>ODCIStatsDelete()</code> for the columns is invoked.
DISASSOCIATE	If user-defined statistics collected with the <code>statistics_type</code> are present, the command fails.
DISASSOCIATE FORCE	Deletes the entry in <code>ASSOCIATION\$</code> and calls <code>ODCIStatsDelete()</code> .
Delete index statistics using the <code>DBMS_STATISTICS</code> package	The <code>ODCIStatsDelete()</code> function is invoked; if any errors are raised, statistics deletion fails and an error is reported.
ASSOCIATE	If an association or user-defined statistics are present for the associated object, the command fails.

 **See Also:**  
[ODCIStatsDelete\(\)](#)

## 10.6 Restrictions and Suggestions

A statistics type is an ordinary object type. Since an object type must have at least one attribute, so must a statistics type. However, because it is never be accessed or set, this is a dummy attribute.

### 10.6.1 Distributed Execution

Oracle's distributed implementation does not support adding functions to the remote capabilities list. All functions referencing remote tables are executed as filters. The placement of the filters occurs outside the optimizer. The cost model reflects this implementation and does not attempt to optimize placement of these predicates.

Since predicates are not shipped to the remote site, you cannot use domain indexes on remote tables. Therefore, the `DESCRIBE` protocol is unchanged, and remote domain indexes are not visible from the local site.

### 10.6.2 System-Managed Storage Tables and ASSOCIATE STATISTICS

If you are creating an `indextype WITH SYSTEM MANAGED STORAGE TABLES`, you should also create its associated `statistics type WITH SYSTEM MANAGED STORAGE TABLES`. If you are collecting statistics on the local indexed column using system partitioned tables, then the Oracle server maintains the system-partitioned statistics tables for them during partition maintenance operations. You can only use the `WITH SYSTEM MANAGED STORAGE`

`TABLES` option when an indextype is associated with the statistics type; otherwise the system raises an error.

### 10.6.3 Aggregate Object-Level Statistics

When using local indexes, it may be useful to maintain both partition-level and aggregate object-level statistics. During partition maintenance operations, the partition level statistics are deleted, while the aggregate object-level statistics are either adjusted to reflect the operation or left "as is" for later recomputation.

The decision to adjust or recompute the aggregate statistics is made based on `_minimal_stats_aggregation` parameter in the server. If the parameter is `FALSE`, the aggregate statistics are recomputed. If the parameter is `TRUE`, the statistics are not recomputed.

### 10.6.4 System-Managed Domain Indexing

The system-managed domain indexing approach supports system-managed statistics that are associated with indextypes; indextype itself should also be system-managed.

### 10.6.5 Collecting and Deleting User-Defined Statistics for System-Managed Indexes

User-defined statistics collection for system-managed domain indexes does not happen when analyzing the domain index itself. Instead, the call to `ODCIStatsCollect()` will be invoked when index statistics are gathered during calls to `GATHER*_STATS` procedures defined inside the `DBMS_STATS` package. Likewise, the call to `ODCIStatsDelete()` to delete domain index statistics will be invoked during calls to `DELETE*_STATS` procedures defined inside the `DBMS_STATS` package.

Example 10-26 demonstrates how to collect statistics for the `TXT_IDX` domain index on the `SCOTT` schema by issuing a call to `DBMS_STATS.GATHER_INDEX_STATS()`.

Example 10-27 shows how to delete statistics for the same index.

Example 10-28 demonstrates how to use the granularity argument to the `DBMS_STATS.GATHER_INDEX_STATS()` to collect partition statistics from the `PT_TXT_IDX` local domain index on the `SCOTT` schema.

Example 10-29 shows how to delete partition statistics for the same index. Example 10-30 and Example 10-31 demonstrate how to collect and delete statistics for a single partition of a local domain index respectively.

#### See Also:

*Oracle Database PL/SQL Packages and Types Reference*

#### 10.6.5.1 Collecting statistics for a system-managed domain index

This topics shows how to collect statistics for a system-managed domain index.

**Example 10-26 Collecting statistics for a system-managed domain index**

```
BEGIN
  SYS.DBMS_STATS.GATHER_INDEX_STATS('SCOTT', 'TXT_IDX');
END;
/
```

### 10.6.5.2 Deleting statistics for a system-managed domain index

This topic shows how to delete statistics for a system-managed domain index.

**Example 10-27 Deleting statistics for a system-managed domain index**

```
BEGIN
  SYS.DBMS_STATS.DELETE_INDEX_STATS('SCOTT', 'TXT_IDX');
END;
/
```

### 10.6.5.3 Collecting statistics for all partitions of a local system-managed domain index

This topic shows how to collect statistics for all partitions of a local system-managed domain index.

**Example 10-28 Collecting statistics for all partitions of a local system-managed domain index**

```
BEGIN
  SYS.DBMS_STATS.GATHER_INDEX_STATS('SCOTT', 'PT_TXT_IDX',
  granularity=>'PARTITION');
END;
/
```

### 10.6.5.4 Deleting statistics for all partitions of a local system-managed domain index

This topic shows how to delete statistics for all partitions of a local system-managed domain index.

**Example 10-29 Deleting statistics for all partitions of a local system-managed domain index**

```
BEGIN
  SYS.DBMS_STATS.DELETE_INDEX_STATS('SCOTT', 'PT_TXT_IDX', cascade_parts=>TRUE);
END;
/
```

### 10.6.5.5 Collecting statistics for partition P2 of a local system-managed domain index

This topic shows how to collect statistics for partition P2 of a local system-managed domain index.

**Example 10-30 Collecting statistics for partition P2 of a local system-managed domain index**

```
BEGIN
  SYS.DBMS_STATS.GATHER_INDEX_STATS('SCOTT', 'PT_TXT_IDX', P2,
granularity=>'PARTITION');
END;
/
```

### 10.6.5.6 Deleting statistics for partition P2 of a local system-managed domain index

This topics shows how to delete statistics for partition P2 of a local system-managed domain index.

**Example 10-31 Deleting statistics for partition P2 of a local system-managed domain index**

```
BEGIN
  SYS.DBMS_STATS.DELETE_INDEX_STATS('SCOTT', 'PT_TXT_IDX', P2,
cascade_parts=>FALSE);
END;
/
```

When the local domain index is composite partitioned, it is possible to collect and delete statistics for all subpartitions of a composite partition as shown in Example 10-32 and Example 10-33.

Example 10-34 and Example 10-35 demonstrate how to collect and delete statistics for a single subpartition.

Additionally, if collection or deletion of statistics in all subpartitions is required, the same calls shown in Example 10-28 and Example 10-29 must be used.

### 10.6.5.7 Collecting statistics for all subpartitions of a composite partition of a local system-managed domain index

This topic shows how to collect statistics for all subpartitions of a composite partition of a local system-managed domain index.

**Example 10-32 Collecting statistics for all subpartitions of a composite partition of a local system-managed domain index**

```
BEGIN
  SYS.DBMS_STATS.GATHER_INDEX_STATS('SCOTT', 'CPT_TXT_IDX', CP2,
granularity=>'PARTITION');
END;
/
```

### 10.6.5.8 Deleting statistics for all subpartitions of a composite partition of a local system-managed domain index

This topic shows how to delete statistics for all subpartitions of a composite partition of a local system-managed domain index

**Example 10-33 Deleting statistics for all subpartitions of a composite partition of a local system-managed domain index**

```
BEGIN
  SYS.DBMS_STATS.DELETE_INDEX_STATS('SCOTT', 'CPT_TXT_IDX', CP2,
  cascade_parts=>FALSE);
END;
/
```

### 10.6.5.9 Collecting statistics for a subpartition of a local system-managed domain index

This topic shows how to collect statistics for a subpartition of a local system-managed domain index

**Example 10-34 Collecting statistics for a subpartition of a local system-managed domain index**

```
BEGIN
  SYS.DBMS_STATS.GATHER_INDEX_STATS('SCOTT', 'CPT_TXT_IDX', CP2_S1,
  granularity=>'SUBPARTITION');
END;
/
```

### 10.6.5.10 Deleting statistics for a subpartition of a local system-managed domain index

This topic shows how to delete statistics for a subpartition of a local system-managed domain index

**Example 10-35 Deleting statistics for a subpartition of a local system-managed domain index**

```
BEGIN
  SYS.DBMS_STATS.DELETE_INDEX_STATS('SCOTT', 'CPT_TXT_IDX', CP2_S1,
  cascade_parts=>FALSE);
END;
/
```

## 10.6.6 Performance

The cost of execution of the queries remains the same with the extensible optimizer if the same plan is chosen. If a different plan is chosen, the execution time should be better assuming that the user-defined cost, selectivity, and statistics collection functions are accurate. In light of this, you are strongly encouraged to provide statistics collection, selectivity, and cost functions for user-defined structures because the optimizer defaults can be inaccurate and lead to an expensive execution plan.

# 11

## Using Cartridge Services

Consider how to use cartridge services.

### 11.1 Introduction to Cartridge Services

Cartridge services are a set of services that help you create data cartridges in the Oracle Extensibility framework.

Using Oracle Cartridge Services offers you the following advantages:

#### **Portability**

Oracle Cartridge Services offers you the flexibility to work across different machine architectures

#### **Flexibility Within Oracle Environments**

Another type of flexibility is offered to you in terms of the fact that all cartridge services work with your Oracle Database, irrespective of the configuration of operations that has been purchased by your client.

#### **Language Independence**

The use of the Globalization Support services lets you internationalize your cartridge. Language independence means that you can have different instances of your cartridge operating in different language environments.

#### **Tight Integration with the Server**

Various cartridge services have been designed to facilitate access with Oracle ORDBMS. This offers far superior performance to client -side programs attempting to perform the same operations.

#### **Guaranteed Compatibility**

Oracle Database is a rapidly evolving technology and it is likely that your clients might be operating with different releases of Oracle. The cartridge services operate with all versions of Oracle Database.

#### **Integration of Different Cartridges**

The integration of cartridge services lets you produce a uniform integration of different data cartridges.

Consider the set of services that you can use as part of your data cartridge. The APIs that describe these interfaces are in [Cartridge Services Using C\\_ C++ and Java](#)

## 11.2 Cartridge Handle

Cartridge services require various handles that are encapsulated inside two types of OCI handles:

### Environment Handle

The environment handle is either `OCIEnv` or `OCI_HTYPE_ENV`. Various cartridge services are required at the process level when no session is available. The `OCIInitialize()` should use the `OCI_OBJECT` option for cartridge service.

### User Session handle

The user session handle is either `OCISession` or `OCI_HTYPE_SESSION`. In a callout, the services can be used when the handle is allocated even without opening a connection back to the database.

All cartridge service calls take a `void *` OCI handle as one of the arguments that may be either an environment or a session handle. While most service calls are allowed with either of the handles, certain calls may not be valid with one of the handles. For example, it may be an error to allocate `OCI_DURATION_SESSION` with an environment handle. An error is typically returned in an error handle.

### 11.2.1 Client Side Usage

Most of the cartridge service can also be used on the client side code. Refer to individual services for restrictions. To use cartridge service on the client side, the OCI environment has to be initialized with `OCI_OBJECT` option. This is automatically effected in a cartridge.

### 11.2.2 Cartridge Side Usage

Most of the services listed in this document can be used in developing a database cartridge, but please refer to documentation of each individual service for restrictions. New service calls are available to obtain the session handle in a callout. The session handle is available without opening a connection back to the server.

### 11.2.3 Making Service Calls

Before using any service, the OCI environment handle must be initialized. All the services take an OCI environment (or `user_session`) handle as an argument. Errors are returned in an OCI error handle. The sub handles required for various service calls are not allocated along with the OCI environment handle. Services which must initialize an environment provide methods to initialize it. [Example 11-1](#) demonstrates the initialization of these handles.

#### Example 11-1 Initializing OCI Handles

```
{
  OCIEnv *envhp;
  OCIError *errhp;
  (void) OCIInitialize(OCI_OBJECT, (dvoid *)0, 0, 0, 0);
  (void) OCIEnvInit(&envhp, OCI_OBJECT, (size_t)0, (dvoid **)0);
  (void) OCIHandleAlloc((dvoid *)envhp, (dvoid **)errhp, OCI_HTYPE_ERROR,
```

```

        (size_t)0, (dvoid **)0);
/* ... use the handles ... */
(void) OCIHandleFree((dvoid *)errhp, OCI_HTYPE_ERROR);
}

```

## 11.2.4 Handling Errors

Routines that return errors generally return `OCI_SUCCESS` or `OCI_ERROR`. Some routines may return `OCI_SUCCESS_WITH_INFO`, `OCI_INVALID_HANDLE`, or `OCI_NO_DATA`. If `OCI_ERROR` or `OCI_SUCCESS_WITH_INFO` is returned, then an error code, an error facility, and possibly an error message can be retrieved by calling `OCIErrorGet`, as demonstrated in [Example 11-2](#).

### Example 11-2 Retrieving Error Information Using `OCIErrorGet()`

```

{
    OCIError *errhp;
    ub4 errcode;
    text buffer[512];
    (void) OCIErrorGet((dvoid *)errhp, 1, (text *)NULL, &errcode, buffer,
        sizeof(buffer), OCI_HTYPE_ERROR);
}

```

## 11.3 Memory Services

The memory service allows the client to allocate or free memory chunks. Each memory chunk is associated with a duration. This allows clients to automatically free all memory associated with a duration (at the end of the duration). The duration determines the heap that is used to allocate the memory. The memory service predefines three kinds of durations: call (`OCI_DURATION_CALL`), statement (`OCI_DURATION_STATEMENT`) and session (`OCI_DURATION_SESSION`).

The client can also create a user duration. The client has to explicitly start and terminate a user duration. Thus, the client can control the length of a user duration. Like the predefined durations, a user duration can be used to specify the allocation duration (for example, memory chunks are freed at the end of the user duration).

Each user duration has a parent duration. A user duration terminates implicitly when its parent duration terminates. A parent duration can be call, statement, transaction, session or any other user duration. Memory allocated in the user duration comes from the heap of its parent duration.

The Oracle RDBMS memory manager supports a variety of memory models. Currently callouts support memory for the duration of that callout. With the extension of row sources to support external indexing, there is a need for memory of durations greater than a callout.

The following functionality is supported:

- Allocate (permanent and friable) memory of following durations
  - call to agent process
  - statement
  - session
  - shared attributes (metadata) for cartridges
- Ability to re-allocate memory



- Ability to create a subduration memory, a sub heap which gets freed up when the parent heap gets freed up. Memory for this sub heap can be allocated and freed.
- Ability to specify zeroed memory
- Ability to allocate large contiguous memory

## 11.4 Maintaining Context

Context management allows the clients to store values across calls. Cartridge services provide a mechanism for saving and restoring context.

Most operating systems that support threads have the concept of thread context. Threads can store thread specific data in this context (or state) and retrieve it at any point. This provides a notion of thread global variable. Typically a pointer which points to the root of a structure is stored in the context.

When the row source mechanism is externalized, you must have a mechanism to maintain state between multiple calls to the same row source.

You must maintain session, statement and process states. Session state includes information about multiple statements that are open, message files based on sessions' Globalization Support settings, and so on. Process state includes shared metadata (including systemwide metadata), message files, and so on. Depending on whether the cartridge application is truly multi threaded, information sharing can be at a process level or system level.

Since a user can be using multiple cartridges at any time, the state must be maintained for each cartridge. This is done by requiring the user to supply a key for each duration.

### 11.4.1 Durations

There are various predefined types of durations supported on memory and context management calls. An additional parameter in all these calls is a context.

- `OCI_DURATION_CALL`. The duration of this operation is that of a callout.
- `OCI_DURATION_STATEMENT`. The duration of this operation is the external row source.
- `OCI_DURATION_SESSION`. The duration of this operation is the user session.
- `OCI_DURATION_PROCESS`. The duration of this is agent process.

## 11.5 Globalization Support

To support multilingual application, Globalization Support functionality is required for cartridges and callouts. `NLSRTL` is a multiplatform, multilingual library current used in RDBMS and provides consistent Globalization Support behavior to all Oracle products.

Globalization Support basic services provide the following language and cultural sensitive functionality:

- Locale information retrieval.
- String manipulation in the format of multibyte and wide-char.
- Character set conversion including Unicode support.

- Messaging mechanism.

## 11.5.1 Globalization Support Language Information Retrieval

An Oracle locale consists of language, territory and character set definitions. The locale determines conventions such as native day and month names; and date, time, number, and currency formats. An internationalized application obeys a user's locale setting and cultural convention. For example, in a German locale setting, users expect to see day and month names in German spelling. The following interface provides a simple way to retrieve local sensitive information.

## 11.5.2 String Manipulation

Two types of data structure are supported for string manipulation: multibyte string and wide char string. Multibyte string is in native Oracle character set encoding, and functions operated on it take the string as a whole unit. Wide char string function provides more flexibility in string manipulation and supports character-based and string-based operations.

The wide char data type we use here is Oracle-specific and not to be confused with the `wchar_t` defined by the ANSI/ISO C standard. The Oracle wide char is always 4 bytes in all the platforms, while `wchar_t` is dependent on the implementation and platform. The idea of Oracle wide char is to normalize multibyte characters to have a fixed-width for easy processing. Round-trip conversion between Oracle wide char and native character set is guaranteed.

The string manipulation can be classified into the following categories:

- Conversion of string between multibyte and wide char.
- Character classifications.
- Case conversion.
- Display length calculation.
- General string manipulation, such as compare, concatenation and searching.

## 11.6 Parameter Manager Interface

The parameter manager provides a set of routines to process parameters from a file or a string. Routines are provided to process the input and to obtain key and value pairs. These key and value pairs are stored in memory and routines are provided which can access the values of the stored parameters.

The input processing routines match the contents of the file or the string against an existing grammar and compare the key names found in the input against the list of known keys that the user has registered. The behavior of the input processing routines can be configured depending on the bits that are set in the flag argument.

The parameters can be retrieved either one at a time, or all at the same time by calling a function that iterates over the stored parameters.

### 11.6.1 Input Processing and Support for Special Characters

Parameters consist of a key, or parameter name, type, and a value and must be specified by the format `key = value`.

Parameters can optionally accept lists of values which may be surrounded by parentheses, either as `key = (value1, ..., valuen)` or as `key = value1, ..., valuen`.

A value can be a string, integer, `OCINumber`, or Boolean. A boolean value starting with 'y' or 't' maps to `TRUE` and a boolean value starting with 'n' or 'f' maps to `FALSE`. The matching for boolean values is case insensitive.

The parameter manager views certain characters as special characters which are not parsed literally. The special characters and their meanings are indicated in [Table 11-1](#).

**Table 11-1 Special Characters**

Character	Description
#	Comment (only for files)
(	Start a list of values
)	End a list of values
"	Start or end of quoted string
'	Start or end of quoted string
=	Separator of keyword and value
\	Escape character

If a special character must be treated literally, then it must either be prefaced by the escape character or the entire string must be surrounded by single or double quotes.

A key string can contain alphanumeric characters only. A value can contain any characters. However, the value cannot contain special characters unless they are quoted or escaped.

## 11.6.2 Parameter Manager Behavior Flag

The routines to process a file or a string use a behavior flag that alters default characteristics of the parameter manager. These bits can be set in the flag:

- `OCI_EXTRACT_CASE_SENSITIVE`. All comparisons are case sensitive. The default is to use case insensitive comparisons.
- `OCI_EXTRACT_UNIQUE_ABBREVS`. Unique abbreviations are allowed for keys. The default is that unique abbreviations are not allowed.
- `OCI_EXTRACT_APPEND_VALUES`. If a value or values are stored for a particular key, then any new values for this key should be appended. The default is to return an error.

## 11.6.3 Key Registration

Before invoking the input processing routines (`OCIExtractFromFile()` or `OCIExtractFromString()`), all of the keys must be registered by calling `OCIExtractSetNumKeys()` followed by `OCIExtractSetKey()`, which requires:

- Name of the key
- Type of the key (`integer`, `string`, `boolean`, `OCINumber`)
- `OCI_EXTRACT_MULTIPLE` is set for the flag value if multiple values are allowed (default: only one value allowed)

- Default value to be used for the key (may be `NULL`)
- Range of allowable integer values specified by starting and ending values, inclusive (may be `NULL`)
- List of allowable string values (may be `NULL`)

## 11.6.4 Parameter Storage and Retrieval

The results of processing the input into a set of keys and values are stored. The validity of the parameters is checked before storing the parameters in memory. The values are checked to see if they are of the proper type. In addition, if you wish, the values can be checked to see if they fall within a certain range of integer values or are members of a list of enumerated string values. Also, if you do not specify that a key can accept multiple values, then an error is returned if a key is specified more than one time in a particular input source. Also, an error is returned if the key is unknown. Values of keys can be retrieved when processing is completed, using specific routines for retrieving string, integer, `OCINumber`, or boolean values.

It is possible to retrieve all parameters at the same time. The function `OCIExtractToList()` must first be called to generate a list of parameters that is created from the parameter structures stored in memory. `OCIExtractToList()` returns the number of unique keys stored in memory, and then `OCIExtractFromList()` can be called to return the list of values associated with each key.

## 11.6.5 Parameter Manager Context

The parameter manager maintains its own context within the `OCI` environment handle. This context stores all the processed parameter information and some internal information. It must be initialized with a call to `OCIExtractInit()` and cleaned up with a call to `OCIExtractTerm()`.

## 11.7 File I/O

The `OCI` file I/O package is designed to make it easier for you to write portable code that interacts with the file system by providing a consistent view of file I/O across multiple platforms.

You must be aware of two issues when using this package in a data cartridge environment. The first issue is that this package does not provide any security when opening files for writing or when creating new files in a directory other than the security provided by the operating system protections on the file and directory. The second issue is that this package does not support the use of file descriptors across calls in a multithreaded server environment.

## 11.8 String Formatting

The `OCI` string formatting package facilitates writing portable code that handles string manipulation by means of the `OCIFormatString()` routine. This is an improved and portable version of `sprintf` that incorporates additional functionality and error checking that the standard `sprintf` does not. This additional functionality includes:

- Arbitrary argument selection.
- Variable width and precision specification.

- Length checking of the buffer.
- Oracle Globalization Support for internationalization.

# 12

## Using User-Defined Aggregate Functions

User-defined aggregate functions may be used both singly and in parallel; consider large aggregation contexts and materialized views.



### See Also:

[User-Defined Aggregate Functions Interface](#) for a detailed description of the `ODCIAggregate` interface.

### 12.1 Overview of User-Defined Aggregate Functions

Oracle provides several pre-defined aggregate functions such as `MAX`, `MIN`, and `SUM` for performing operations on a set of rows. These pre-defined aggregate functions can be used only with scalar data, not with complex data types such as multimedia data stored using object types, opaque types, and LOBs. You can, however, define custom implementations of these functions for complex data types. You can also define entirely new aggregate functions to use with complex data. User-defined aggregate functions can be used in SQL DML statements just like Oracle's built-in aggregates. When functions are registered with the server, Oracle simply invokes the user-defined aggregation routines supplied by you instead of the native routines. User-defined aggregates can also be used with scalar data, such as complex statistical data necessary for scientific applications.

User-defined aggregates are a feature of the Extensibility Framework, and you can implement them using `ODCIAggregate` interface routines.

You can create a user-defined aggregate function by implementing a set of routines collectively known as the `ODCIAggregate` routines. You can implement these routines as methods within an object type, so the implementation can be in any language that Oracle supports, PL/SQL, C, C++ or Java. When the object type is defined and the routines are implemented in the type body, use the `CREATE FUNCTION` statement to create the aggregate function.

Each user-defined aggregate function uses up to four `ODCIAggregate` routines, or steps, to define internal operations that any aggregate function performs, namely: initialization, iteration, merging, and termination.

- Initialization is accomplished by the `ODCIAggregateInitialize()` routine, which is invoked by Oracle to initialize the computation of the user-defined aggregate. The initialized aggregation context is passed back to Oracle as an object type instance.
- Iteration is performed through the `ODCIAggregateIterate()` routine, which is repeatedly invoked by Oracle. On each invocation, a new value or a set of new values and the current aggregation context are passed in. The routine processes the new values and returns the updated aggregation context. This routine is invoked for every non-NULL value in the underlying group. NULL values are ignored during aggregation and are not passed to the routine.

- Merging is performed by `ODCIAggregateMerge()`, a routine invoked by Oracle to combine two aggregation contexts. This routine takes the two contexts as inputs, combines them, and returns a single aggregation context.
- Termination takes place when the `ODCIAggregateTerminate()` routine is invoked by Oracle as the final step of aggregation. The routine takes the aggregation context as input and returns the resulting aggregate value.

The process is illustrated in the [Using User-Defined Aggregate Functions](#) section.

## 12.1.1 Using User-Defined Aggregate Functions

Consider the aggregate function `AVG()` in the following statement:

```
SELECT AVG(T.Sales)
FROM AnnualSales T
GROUP BY T.State;
```

To perform this computation, the aggregate function `AVG()` goes through these steps:

1. Initializes the computation by initializing the aggregation context, or the rows over which aggregation is performed:

```
runningSum = 0; runningCount = 0;
```

2. Iteratively processes each successive input value and updates the context:

```
runningSum += inputval; runningCount++;
```

3. [Optional] Merge by combining the two aggregation contexts and return a single context. This operation combines the results of aggregation over subsets to obtain the aggregate over the entire set. This extra step can be required during either serial or parallel evaluation of an aggregate. If needed, it is performed before step 4:

```
runningSum = runningSum1 + runningSum2;
runningCount = runningCount1 + runningCount2
```

[Evaluating User-Defined Aggregates in Parallel](#) describes this step in greater detail.

4. Terminates by computing the result; uses the context to return the resultant aggregate value:

```
return (runningSum/runningCount);
```

If `AVG()` were a user-defined function, the object type that embodies it would implement a method for a corresponding `ODCIAggregate` routine for each of these steps. The variables `runningSum` and `runningCount`, which determine the state of the aggregation in the example, would be attributes of that object type.

## 12.2 Creating a User-Defined Aggregate

The process of creating a user-defined aggregate function has two steps, illustrated in [Example 12-1](#) and [Example 12-2](#). Both examples use the `SpatialUnion()` aggregate function defined by Oracle Spatial. The function computes the bounding geometry over a set of input geometries.

### Example 12-1 Implementing the ODCIAggregate Interface

The `ODCIAggregate` routines are implemented as methods within an object type `SpatialUnionRoutines`. The actual implementation could be in any Oracle-supported language for type methods, such as PL/SQL, C, C++ or Java.

```
CREATE TYPE SpatialUnionRoutines(  
    STATIC FUNCTION ODCIAggregateInitialize( ... ) ... ,  
    MEMBER FUNCTION ODCIAggregateIterate(...) ... ,  
    MEMBER FUNCTION ODCIAggregateMerge(...) ... ,  
    MEMBER FUNCTION ODCIAggregateTerminate(...) ...  
);  
  
CREATE TYPE BODY SpatialUnionRoutines IS  
    ...  
END;
```

### Example 12-2 Defining a User-Defined Aggregate Function

This function definition creates the `SpatialUnion()` aggregate function by specifying its signature and the object type that implements the `ODCIAggregate` interface:

```
CREATE FUNCTION SpatialUnion(x Geometry) RETURN Geometry  
AGGREGATE USING SpatialUnionRoutines;
```

## 12.3 Using a User-Defined Aggregate

User-defined aggregates can be used just like built-in aggregate functions in SQL DML and query statements. They can appear in the `SELECT` list, `ORDER BY` clause, or as part of the predicate in the `HAVING` clause. The following [Example 12-3](#), [Example 12-4](#) and [Example 12-5](#) illustrate some options.

#### See Also:

*Oracle Database Data Warehousing Guide* for information about `GROUP BY` extensions such as `ROLLUP`, `CUBE` and grouping sets

### 12.3.1 Using the SELECT Statement with User-Defined Aggregate Functions

#### Example 12-3 Using the SELECT Statement with User-Defined Aggregate Functions

The following query can be used to compute state boundaries by aggregating the geometries of all counties belonging to the same state:

```
SELECT SpatialUnion(geometry)  
FROM counties  
GROUP BY state
```



## 12.3.2 Using the HAVING Clause with User-Defined Aggregate Functions

### Example 12-4 Using the HAVING Clause with User-Defined Aggregate Functions

User-defined aggregates can be used in the `HAVING` clause to eliminate groups from the output based on the results of the aggregate function. Here, `MyUDAG()` is a user-defined aggregate:

```
SELECT groupcol, MyUDAG(col)
FROM tab
GROUP BY groupcol
HAVING MyUDAG(col) > 100
ORDER BY MyUDAG(col);
```

## 12.3.3 Using Query Options with User-Defined Aggregate Functions

### Example 12-5 Using other Query Options with User-Defined Aggregate Functions

User-defined aggregates can take `DISTINCT` or `ALL` (default) options on the input parameter. `DISTINCT` causes duplicate values to be ignored while computing an aggregate. The `SELECT` statement that contains a user-defined aggregate can also include `GROUP BY` extensions such as `ROLLUP`, `CUBE` and grouping sets:

```
SELECT ..., MyUDAG(col)
FROM tab
GROUP BY ROLLUP(gcol1, gcol2);
```

The `ODCIAggregateMerge()` interface is invoked to compute super aggregate values in such roll-up operations.

## 12.4 Evaluating User-Defined Aggregates in Parallel

Like built-in aggregate functions, user-defined aggregates can be evaluated in parallel.

The aggregation contexts generated by aggregating subsets of the rows within the parallel slaves are sent back to the next parallel step, either the query coordinator or the next slave set. It then merges the aggregation contexts, and then invokes the Terminate routine to obtain the aggregate value. This behaviour is illustrated in [Figure 12-1](#).

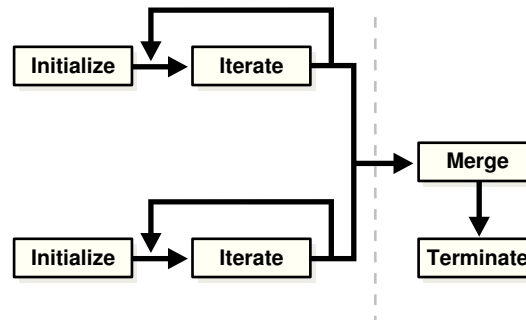
**Figure 12-1** Sequence of Calls for Parallel Evaluation of User-Defined Aggregates

You should note that the aggregate function must be declared to be parallel-enabled, as shown in [Example 12-6](#):

**Example 12-6** Parallel-Enabling a User-Defined Aggregate Function

```
CREATE FUNCTION MyUDAG(...) RETURN ...
PARALLEL_ENABLE AGGREGATE USING MyAggrRoutines;
```

## 12.5 Handling Large Aggregation Contexts

When the implementation type methods are implemented in an external language, such as C++ or Java, the aggregation context must be passed back and forth between the Oracle server process and the external function's language environment each time an implementation type method is called. This can have an adverse effect on performance as the size of the aggregation context increases.

To enhance performance, you can store the aggregation context in external memory, allocated in the external function's execution environment. You can then pass the reference or key between the Oracle server and the external function. The key itself should be stored in the implementation type instance, the `self`. This approach keeps the implementation type instance small so that it can be transferred quickly. Another advantage of this strategy is that the memory used to hold the aggregation context is allocated in the function's execution environment, such as `extproc`, and not in the Oracle server.

Usually you should use `ODCIAggregateInitialize()` to allocate the memory to hold the aggregation context and store the reference to it in the implementation type instance. In subsequent calls, the external memory and the aggregation context that it contains can be accessed using the reference. The external memory should usually be freed in `ODCIAggregateTerminate()`. `ODCIAggregateMerge()` should free the external memory used to store the merged context (the second argument of `ODCIAggregateMerge()` after the merge is finished).

 **See Also:**

- [ODCIAggregateInitialize\(\)](#)
- [ODCIAggregateTerminate\(\)](#)
- [ODCIAggregateMerge\(\)](#)

## 12.5.1 External Context and Parallel Aggregation

With parallel execution of queries with user-defined aggregates, the entire aggregation context, which comprises all partial aggregates computed by slave processes, must sometimes be transmitted to another slave or to the master process. You can implement the optional routine `ODCIAggregateWrapContext()` to collect all the partial aggregates. If a user-defined aggregate is being evaluated in parallel, and `ODCIAggregateWrapContext()` is defined, Oracle invokes the routine to copy all external context references into the implementation type instance and then frees the external memory. To support `ODCIAggregateWrapContext()`, the implementation type must contain attributes to hold the aggregation context and another attribute to hold the key that identifies the external memory.

When the aggregation context is stored externally, the key attribute of the implementation type should contain the reference identifying the external memory, and the remaining attributes of the implementation type should be `NULL`. After a `ODCIAggregateWrapContext()` call runs successfully, the key attribute should be `NULL`, and the other attributes should hold the actual aggregation context.

Each of the implementation type's member methods should begin by checking whether the context is **inline** (contained in the implementation type instance) or in external memory. If the context is inline, as it would be if it was sent from another parallel slave, it should be copied to external memory so that it can be passed by reference.

Implementation of the `ODCIAggregateWrapContext()` routine is optional. It is necessary only when external memory holds the aggregation context, and the user-defined aggregate is evaluated in parallel. If the user-defined aggregate is never evaluated in parallel, `ODCIAggregateWrapContext()` is not needed. If the `ODCIAggregateWrapContext()` method is not defined, Oracle assumes that the aggregation context is not stored externally and does not try to call the method.

 **Note:**

[ODCIAggregateWrapContext\(\)](#)

### 12.5.1.1 Using External Memory to Store Aggregate Context

This example shows how an aggregation context type that contains references to external memory can also store the entire context, when needed.

The 4 byte `key` parameter is used to look up the external context. When `NULL`, it implies that the entire context value is held by the rest of the attributes in the object. The other attributes, such as `GeometrySet`, correspond to the actual aggregation context. If the `key`

value is not `NULL`, these attributes must have a `NULL` value. However, when the context object is self-contained, as after a call to `ODCIAggregateWrapContext()`, these attributes hold the current context values.

```
CREATE TYPE MyAggrRoutines AS OBJECT
(
  key RAW(4),
  ctxval GeometrySet,
  ctxval2 ...
);
```

## 12.5.2 User-Defined Aggregates and Analytic Functions

Analytic functions enable you to compute various cumulative, moving, and centered aggregates over a set of rows called a window. For each row in a table, analytic functions return a value computed on the other rows contained in the given row's window. These functions provide access to several rows of a table without a self-join. User-defined aggregates can be used as analytic functions.

### 12.5.2.1 Using User-Defined Aggregates and Analytic Functions

```
SELECT Account_number, Trans_date, Trans_amount,
       MyAVG (Trans_amount) OVER(
           PARTITION BY Account_number ORDER BY Trans_date
           RANGE INTERVAL '7' DAY PRECEDING) AS mavg_7day
FROM Ledger;
```

## 12.5.3 Reuse of Aggregation Context for Analytic Functions

When a user-defined aggregate is used as an analytic function, the aggregate is calculated for each row's corresponding window. Generally, each successive window contains largely the same set of rows, such that the new aggregation context, the new window, differs by only a few rows from the old aggregation context, the previous window. To reuse the aggregation context, any new rows that were not in the old context must be iterated over to add them, and any rows from the old context that do not belong in the new context must be removed. If the aggregation context cannot be reused, all the rows it contains must be reiterated to rebuild it.

You can implement an optional routine, `ODCIAggregateDelete()`, to allow Oracle to reuse the aggregation context more efficiently. `ODCIAggregateDelete()` removes from the aggregation context rows from the previous context that are not in the new (current) window. Oracle calls this routine for each row that must be removed. For each row that must be added, Oracle calls `ODCIAggregateIterate()`.

If the new aggregation context is a superset of the old one, then it contains all the rows from the old context and no rows must be deleted. Oracle then reuses the old context even if `ODCIAggregateDelete()` is not implemented.

 **See Also:**

- *Oracle Database Data Warehousing Guide* for information about analytic functions
- [ODCIAggregateDelete\(\)](#)
- [ODCIAggregateIterate\(\)](#)

## 12.5.4 External Context and User-Defined Analytic Functions

When user-defined aggregates are used as analytic functions, the aggregation context can be reused from one window to the next. In these cases, the flag argument of the `ODCIAggregateTerminate()` function has its `ODCI_AGGREGATE_REUSE_CTX` bit set to indicate that the external memory holding the aggregation context should not be freed. Also, the `ODCIAggregateInitialize()` method is passed the implementation type instance of the previous window, so instead of having to allocate memory again, you can access and re-initialize the external memory previously allocated. To support external context for user-defined analytic functions, you should follow these steps:

1. `ODCIAggregateInitialize()` - If the implementation type instance passed is not `NULL`, use the previously allocated external memory instead of allocating new external memory, and reinitialize the aggregation context.
2. `ODCIAggregateTerminate()` - Free external memory only if the bit `ODCI_AGGREGATE_REUSE_CTX` of the flag argument is not set.
3. `ODCIAggregateMerge()` - Free external memory associated with the merged aggregation context.
4. `ODCIAggregateTerminate()` - Copy the aggregation context from the external memory into the implementation type instance, and free the external memory.
5. All member methods - First determine if the context is stored externally or inline. If the context is inline, allocate external memory and copy the context there.

 **See Also:**

- [ODCIAggregateInitialize\(\)](#)
- [ODCIAggregateMerge\(\)](#)
- [ODCIAggregateTerminate\(\)](#)

## 12.6 Using Materialized Views with User-Defined Aggregates

A materialized view definition can contain user-defined aggregates and built-in aggregate operators, as demonstrated in [Example 12-7](#).

To enable the materialized view for query rewrite, the user-defined aggregates in the materialized view must be declared as `DETERMINISTIC`, as demonstrated in [Example 12-8](#).

When a user-defined aggregate is dropped or re-created, all of its dependent materialized views are marked invalid.

### Example 12-7 Creating Materialized Views

```
CREATE MATERIALIZED VIEW MyMV AS
SELECT gcols, MyUDAG(c1) FROM tab GROUP BY (gcols);
```

### Example 12-8 Enabling Materialized Views for Query Rewrite

```
CREATE FUNCTION MyUDAG(x NUMBER) RETURN NUMBER
DETERMINISTIC
AGGREGATE USING MyImplType;

CREATE MATERIALIZED VIEW MyMV
ENABLE QUERY REWRITE AS
SELECT gcols, MyUDAG(c1) FROM tab GROUP BY (gcols);
```

#### See Also:

*Oracle Database Data Warehousing Guide* for information about materialized views

## 12.7 Creating and Using a User-Defined Aggregate Function

[Example 12-9](#) illustrates how to create and use a simple user-defined aggregate function, `SecondMax()`.

### Example 12-9 Creating and Using a User-Defined Aggregate Function

`SecondMax()` returns the second-largest value in a set of numbers.

1. Implement the type `SecondMaxImpl` to contain the `ODCIAggregate` routines:

```
create type SecondMaxImpl as object
(
  max NUMBER, -- highest value seen so far
  secmax NUMBER, -- second highest value seen so far
  static function ODCIAggregateInitialize(sctx IN OUT SecondMaxImpl)
  return number,
  member function ODCIAggregateIterate(self IN OUT SecondMaxImpl,
  value IN number) return number,
  member function ODCIAggregateTerminate(self IN SecondMaxImpl,
  returnValue OUT number, flags IN number) return number,
  member function ODCIAggregateMerge(self IN OUT SecondMaxImpl,
  ctx2 IN SecondMaxImpl) return number
);
/
```

2. Implement the type body for `SecondMaxImpl`:

```
create or replace type body SecondMaxImpl is
static function ODCIAggregateInitialize(sctx IN OUT SecondMaxImpl)
return number is
```

```

begin
    sctx := SecondMaxImpl(0, 0);
    return ODCIConst.Success;
end;

member function ODCIAggregateIterate(self IN OUT SecondMaxImpl, value IN number)
return number is
begin
    if value > self.max then
        self.secmax := self.max;
        self.max := value;
    elsif value > self.secmax then
        self.secmax := value;
    end if;
    return ODCIConst.Success;
end;

member function ODCIAggregateTerminate(self IN SecondMaxImpl,
    returnValue OUT number, flags IN number) return number is
begin
    returnValue := self.secmax;
    return ODCIConst.Success;
end;

member function ODCIAggregateMerge(self IN OUT SecondMaxImpl, ctx2 IN
SecondMaxImpl) return number is
begin
    if ctx2.max > self.max then
        if ctx2.secmax > self.secmax then
            self.secmax := ctx2.secmax;
        else
            self.secmax := self.max;
        end if;
        self.max := ctx2.max;
    elsif ctx2.max > self.secmax then
        self.secmax := ctx2.max;
    end if;
    return ODCIConst.Success;
end;
end;
/

```

**3. Create the user-defined aggregate:**

```

CREATE FUNCTION SecondMax (input NUMBER) RETURN NUMBER
PARALLEL_ENABLE AGGREGATE USING SecondMaxImpl;

```

**4. Use SecondMax():**

```

SELECT SecondMax(salary), department_id
FROM MyEmployees
GROUP BY department_id
HAVING SecondMax(salary) > 9000;

```

# 13

## Using Pipelined and Parallel Table Functions

The table functions and the generic datatypes `ANYTYPE`, `ANYDATA`, and `ANYDATASET` are often used with table functions.

### 13.1 Overview of Table Functions

Table functions are functions that produce a collection of rows (either a nested table or a varray) that can be queried like a physical database table. You use a table function like the name of a database table, in the `FROM` clause of a query.

A table function can take a collection of rows as input. An input collection parameter can be either a collection type or a `REF CURSOR`.

Table function may be executed in parallel, and returned rows can be streamed directly to the next process without intermediate staging. Rows from a collection returned by a table function can also be pipelined; this means that they are iteratively returned as they are produced, instead of being returned in a single batch after all processing of the table function's input is completed.

Streaming, pipelining, and parallel execution of table functions can improve performance in the following manner:

- By enabling multithreaded, concurrent execution of table functions
- By eliminating intermediate staging between processes
- By improving query response time: With non-pipelined table functions, the entire collection returned by a table function must be constructed and returned to the server before the query can return a single result row. Pipelining enables rows to be returned iteratively, as they are produced. This also reduces the memory that a table function requires, as the object cache does not have to materialize the entire collection.
- By iteratively providing result rows from the collection returned by a table function as the rows are produced instead of waiting until the entire collection is staged in tables or memory and then returning the entire collection

Figure 13-1 shows a typical data-processing scenario in which data goes through several (in this case, three) transformations, implemented by table functions, before finally being loaded into a database. In this scenario, the table functions are not run in parallel, and the entire result collection must be staged after each transformation.

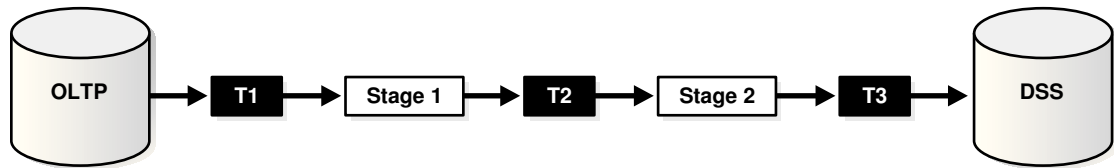

**Figure 13-1** Typical Data Processing with Non-Parallel, Non-Pipelined Table Functions

By contrast, [Figure 13-2](#) shows how streaming and parallel execution can streamline the same scenario.

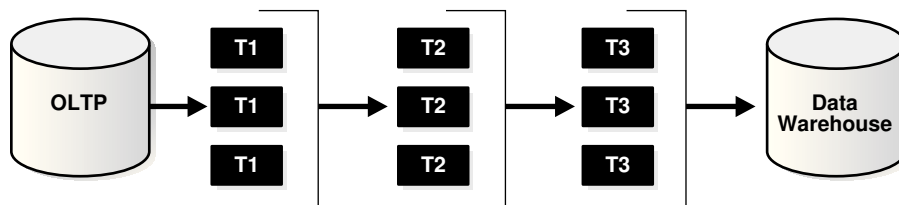
**Figure 13-2** Data Processing Using Pipelining and Parallel Execution

## 13.2 Table Function Concepts

Consider table functions and some concepts related to pipelining and parallel execution of these table functions.

### 13.2.1 Table Functions

Table functions return a collection type instance and can be queried like a table by calling the function in the `FROM` clause of a query. Table functions use the `TABLE` keyword.

The following example shows a table function `GetBooks` that takes a `CLOB` as input and returns an instance of the collection type `BookSet_t`. The `CLOB` column stores a catalog listing of books in some format (either proprietary or following a standard such as XML). The table function returns all the catalogs and their corresponding book listings. The collection type `BookSet_t` is defined in [Example 13-1](#).

The `CLOB`s are stored in a table `Catalogs`, as demonstrated in [Example 13-2](#).

Function `GetBooks()` is defined in [Example 13-3](#).

The query in [Example 13-4](#) returns all the catalogs and their corresponding book listings.

#### Example 13-1 Creating a Collection Type

```
CREATE TYPE Book_t AS OBJECT
( name VARCHAR2(100),
  author VARCHAR2(30),
  abstract VARCHAR2(1000));

CREATE TYPE BookSet_t AS TABLE OF Book_t;
```

**Example 13-2 Storing a Clob in a Table**

```
CREATE TABLE Catalogs
( name VARCHAR2(30),
  cat CLOB);
```

**Example 13-3 Creating a Function that Returns a Collection Type**

```
CREATE FUNCTION GetBooks(a CLOB) RETURN BookSet_t;
```

**Example 13-4 Using a Collection Type in a Query**

```
SELECT c.name, Book.name, Book.author, Book.abstract
FROM Catalogs c, TABLE(GetBooks(c.cat)) Book;
```

## 13.2.2 Pipelined Table Functions

Data is said to be pipelined if it is consumed by a consumer (transformation) as soon as the producer (transformation) produces it, without being staged in tables or a cache before being input to the next transformation.

Pipelining enables a table function to return rows faster and can reduce the memory required to cache a table function's results.

A pipelined table function can return the table function's result collection in subsets. The returned collection behaves like a stream that can be fetched from on demand. This makes it possible to use a table function like a virtual table.

Pipelined table functions can be implemented in two ways:

- In the native PL/SQL approach, the consumer and producers can run on separate execution threads (either in the same or different process context) and communicate through a pipe or queuing mechanism. This approach is similar to co-routine execution.
- In the interface approach, the consumer and producers run on the same execution thread. Producer explicitly returns the control back to the consumer after producing a set of results. In addition, the producer caches the current state so that it can resume where it left off when the consumer invokes it again.

The interface approach requires you to implement a set of well-defined interfaces in a procedural language.

The co-routine execution model provides a simpler, native PL/SQL mechanism for implementing pipelined table functions, but this model cannot be used for table functions written in C or Java. The interface approach, on the other hand, can. The interface approach requires the producer to save the current state information in a context object before returning so that this state can be restored on the next invocation.

In this discussion, the term *table function* refers to a *pipelined* table function— a table function that returns a collection in an iterative, pipelined way.

## 13.2.3 Pipelined Table Functions with REF CURSOR Arguments

A pipelined table function can accept any argument that regular functions accept. A table function that accepts a `REF CURSOR` as an argument can serve as a transformation function. That is, it can use the `REF CURSOR` to fetch the input rows, perform some

transformation on them, and then pipeline the results out (using either the interface approach or the native PL/SQL approach).

For example, the following code sketches the declarations that define a `StockPivot` function. This function converts a row of the type `(Ticker, OpenPrice, ClosePrice)` into two rows of the form `(Ticker, PriceType, Price)`. Calling `StockPivot` for the row `("ORCL", 41, 42)` generates two rows: `("ORCL", "O", 41)` and `("ORCL", "C", 42)`.

Input data for the table function might come from a source such as table `StockTable`:

```
CREATE TABLE StockTable (
  ticker VARCHAR(4),
  openprice NUMBER,
  closeprice NUMBER
);
```

The declarations are in [Example 13-5](#).

[Example 13-6](#) uses the `StockPivot` table function.

In the preceding query, the pipelined table function `StockPivot` fetches rows from the `CURSOR` subquery `SELECT * FROM StockTable`, performs the transformation, and pipelines the results back to the user as a table. The function produces two output rows (collection elements) for each input row.

Note that when a `CURSOR` subquery is passed from SQL to a `REF CURSOR` function argument as in the preceding example, the referenced cursor is open when the function begins executing.

Note also that cursor operations are not allowed for `REF CURSOR` variables based on table functions: `SELECT FOR UPDATE`, and `WHERE CURRENT OF`.



#### See Also:

[Pipelined Table Functions: Interface Approach Example](#) for a complete implementation of this table function using the interface approach, in both C and Java.

### Example 13-5 Declaring a Pipelined Table Function with REF CURSOR Arguments

```
-- Create the types for the table function's output collection
-- and collection elements

CREATE TYPE TickerType AS OBJECT
(
  ticker VARCHAR2(4),
  PriceType VARCHAR2(1),
  price NUMBER
);

CREATE TYPE TickerTypeSet AS TABLE OF TickerType;

-- Define the ref cursor type

CREATE PACKAGE refcur_pkg IS
  TYPE refcur_t IS REF CURSOR RETURN StockTable%ROWTYPE;
```

```
END refcur_pkg;
/

-- Create the table function

CREATE FUNCTION StockPivot(p refcur_pkg.refcur_t) RETURN TickerTypeSet
PIPELINED ... ;
/
```

### Example 13-6 Using a Pipelined Table Function with REF CURSOR Arguments

```
SELECT * FROM TABLE(StockPivot(CURSOR(SELECT * FROM StockTable)));
```

## 13.2.4 Parallel Execution of Table Functions

With parallel execution of a function that appears in the `SELECT` list, execution of the function is pushed down to and conducted by multiple slave scan processes. These each execute the function on a segment of the function's input data.

For example, the query

```
SELECT f(coll) FROM tab;
```

is parallelized if `f` is a pure function. The SQL executed by a slave scan process is similar to:

```
SELECT f(coll) FROM tab WHERE ROWID BETWEEN :b1 AND :b2;
```

Each slave scan operates on a range of rowids and applies function `f` to each contained row. Function `f` is then executed by the scan processes; it does not run independently of them.

Unlike a function that appears in the `SELECT` list, a table function is called in the `FROM` clause and returns a collection. This affects the way that table function input data is partitioned among slave scans because the partitioning approach must be appropriate for the operation that the table function performs. (For example, an `ORDER BY` operation requires input to be range-partitioned, whereas a `GROUP BY` operation requires input to be hash partitioned.)

A table function itself specifies in its declaration the partitioning approach that is appropriate for it, as described in "Input Data Partitioning". The function is then executed in a two-stage operation. First, one set of slave processes partitions the data as directed in the function's declaration; then a second set of slave scans executes the table function in parallel on the partitioned data. The table function in the following query has a `REF CURSOR` parameter:

```
SELECT * FROM TABLE(f(CURSOR(SELECT * FROM tab)));
```

The scan is performed by one set of slave processes, which redistributes the rows (based on the partitioning method specified in the function declaration) to a second set of slave processes that actually executes function `f` in parallel.

## 13.3 Pipelined Table Functions

Consider issues involved in implementing pipelined table functions.

## 13.3.1 Implementation Choices for Pipelined Table Functions

As noted previously, two approaches are supported for implementing pipelined table functions: the interface approach and the PL/SQL approach.

The interface approach requires the user to supply a type that implements a predefined Oracle interface consisting of start, fetch, and close operations. The type is associated with the table function when the table function is created. During query execution, the `fetch` method is invoked repeatedly to iteratively retrieve the results. With the interface approach, the methods of the implementation type associated with the table function can be implemented in any of the supported internal or external languages (including PL/SQL, C/C++, and Java).

With the PL/SQL approach, a single PL/SQL function includes a special instruction to pipeline results (single elements of the collection) out of the function instead of returning the whole collection as a single value. The native PL/SQL approach is simpler to implement because it requires writing only one PL/SQL function.

The approach used to implement pipelined table functions does not affect the way they are used. Pipelined table functions are used in SQL statements in exactly the same way regardless of the approach used to implement them.

## 13.3.2 Declaring Pipelined Table Functions

You declare a pipelined table function by specifying the `PIPELINED` keyword. This keyword indicates that the function returns rows iteratively. The return type of the pipelined table function must be a collection type (a nested `table` or a `varray`).

[Example 13-7](#) shows declarations of pipelined table functions implemented using the interface approach. The interface routines for functions `GetBooks` and `StockPivot` have been implemented in the types `BookMethods` and `StockPivotImpl`, respectively.

[Example 13-8](#) shows declarations of the same table functions implemented using the native PL/SQL approach.

### Example 13-7 Declaring Pipelined Table Functions for the Interface Approach

```
CREATE FUNCTION GetBooks(cat CLOB) RETURN BookSet_t PIPELINED USING BookMethods;

CREATE FUNCTION StockPivot(p refcur_pkg.refcur_t)
  RETURN TickerTypeSet PIPELINED USING StockPivotImpl;
```

### Example 13-8 Declaring Pipelined Table Functions for the Native PL/SQL Approach

```
CREATE FUNCTION GetBooks(cat CLOB) RETURN BookSet_t PIPELINED IS ...;

CREATE FUNCTION StockPivot(p refcur_pkg.refcur_t) RETURN TickerTypeSet
PIPELINED IS...;
```

## 13.3.3 Implementing the Native PL/SQL Approach

In PL/SQL, the `PIPE ROW` statement causes a table function to pipe a row and continue processing. The statement enables a PL/SQL table function to return rows as soon as they are produced. This is demonstrated in [Example 13-9](#). For performance reasons, the PL/SQL run-time system provides the rows to the consumer in batches.

In [Example 13-9](#), the `PIPE ROW(out_rec)` statement pipelines data out of the PL/SQL table function.

The `PIPE ROW` statement may be used only in the body of pipelined table functions; an error is raised if it is used anywhere else. The `PIPE ROW` statement can be omitted for a pipelined table function that returns no rows.

A pipelined table function must have a `RETURN` statement that does not return a value. The `RETURN` statement transfers the control back to the consumer and ensures that the next fetch gets a `NO_DATA_FOUND` exception.

### Example 13-9 Implementing a Pipelined Table Function for the Native PL/SQL Approach

```
CREATE FUNCTION StockPivot(p refcur_pkg.refcur_t) RETURN TickerTypeSet
PIPELINED IS
  out_rec TickerType := TickerType(NULL,NULL,NULL);
  in_rec p%ROWTYPE;
BEGIN
  LOOP
    FETCH p INTO in_rec;
    EXIT WHEN p%NOTFOUND;
    -- first row
    out_rec.ticker := in_rec.Ticker;
    out_rec.PriceType := 'O';
    out_rec.price := in_rec.OpenPrice;
    PIPE ROW(out_rec);
    -- second row
    out_rec.PriceType := 'C';
    out_rec.Price := in_rec.ClosePrice;
    PIPE ROW(out_rec);
  END LOOP;
  CLOSE p;
  RETURN;
END;
```

## 13.3.4 Pipelining Between PL/SQL Table Functions

With serial execution, results are pipelined from one PL/SQL table function to another using an approach similar to co-routine execution. [Example 13-10](#) pipelines results from function `g` to function `f`.

Parallel execution works similarly, except that each function executes in a different process or set of processes.

### Example 13-10 Pipelining Function Results from One Function to Another

```
SELECT * FROM TABLE(f(CURSOR(SELECT * FROM TABLE(g()))));
```

## 13.3.5 Combining PIPE ROW with AUTONOMOUS\_TRANSACTION

Because table functions pass control back and forth to a calling routine as rows are produced, there is a restriction on combining table functions and `PRAGMA AUTONOMOUS_TRANSACTION`s. If a table function is part of an autonomous transaction, it must `COMMIT` or `ROLLBACK` before each `PIPE ROW` statement, to avoid an error in the calling subprogram.

## 13.3.6 Implementing the Interface Approach

To use the interface approach, you must define an implementation type that implements the `ODCITable` interface. This interface consists of start, fetch, and close routines whose signatures are specified by Oracle and which you implement as methods of the type.

Oracle invokes the methods to perform the following steps in the execution of a query that contains a table function:

1. Start by initializing the scan context parameter, using the `ODCITableStart()` function.
2. Fetch to produce a subset of the rows in the result collection. The `ODCITableFetch()` method is invoked as many times as necessary to return the entire collection.
3. Close and clean up (release memory and so on) using `ODCITableClose()` after the last `ODCITableFetch()`.

The `ODCITable` interface also defines two optional routines, `ODCITablePrepare()` and `ODCITableDescribe()`, that are invoked at compilation time:

- `ODCITableDescribe()` determines the structure of the data type the table function returns, in situations where this cannot be defined in a static manner.
- `ODCITablePrepare()` initializes the scan context parameter. If this method is implemented, the scan context it prepares is passed to the `ODCITableStart()` routine, and the context is maintained between restarts of the table function. It also provides projection information and supports the return of transient anonymous types.

### See Also:

- [ODCITableClose\(\)](#)
- [ODCITableDescribe\(\)](#)
- [ODCITableFetch\(\)](#)
- [ODCITablePrepare\(\)](#)
- [ODCITableStart\(\)](#)

### 13.3.6.1 Scan Context

For the fetch method to produce the next set of rows, a table function must be able to maintain context between successive invocations of the interface routines to fetch another set of rows. This context, called the scan context, is defined by the attributes of the implementation type. A table function preserves the scan context by modeling it in an object instance of the implementation type.

### 13.3.6.2 Start Routine

The start routine `ODCITableStart()` is the first routine that is invoked to begin retrieving rows from a table function. This routine typically performs the setup needed for the scan, creating the scan context (as an object instance `sctx`) and returning it to Oracle. However, if `ODCITablePrepare()` is implemented, it creates the scan context, which is then passed to the `ODCITableStart()` routine. The arguments to the table function, specified by the user in the `SELECT` statement, are passed in as parameters to this routine.

Note that any `REF CURSOR` arguments of a table function must be declared as `SYS_REFCURSOR` type in the declaration of the `ODCITableStart()`. Ordinary `REF CURSOR` types cannot be used as formal argument types in `ODCITableStart()`. Ordinary `REF CURSOR` types can only be declared in a package, and types defined in a package cannot be used as formal argument types in a type method. To use a `REF CURSOR` type in `ODCITableStart()`, you must use the system-defined `SYS_REFCURSOR` type.

 **See Also:**

- [ODCITablePrepare\(\)](#)
- [ODCITableStart\(\)](#)

### 13.3.6.3 Fetch Routine

The fetch routine `ODCITableFetch()` is invoked one or more times by Oracle to retrieve all the rows in the table function's result set. The scan context is passed in as a parameter. This routine returns the next subset of one or more rows.

The fetch routine is called by Oracle repeatedly until all the rows have been returned by the table function. Returning more rows in each invocation of `ODCITableFetch()` reduces the number of fetch calls that must be made and thus improves performance. The table function should return a null collection to indicate that all rows have been returned.

The `nrows` parameter indicates the number of rows that are required to satisfy the current OCI call. For example, if the current OCI call is an `ODCITableFetch()` that requested 100 rows, and 20 rows have been returned, then the `nrows` parameter is equal to 80. The fetch function is allowed to return a different number of rows. The main purpose of this parameter is to prevent `ODCITableFetch()` from returning more rows than actually required. If `ODCITableFetch()` returns more rows than the value of this parameter, the rows are cached and returned in subsequent `ODCITableFetch()` calls, or they are discarded if the OCI statement handle is closed before they are all fetched.

 **See Also:**

- [ODCITableFetch\(\)](#)



### 13.3.6.4 Close Routine

The close routine `ODCITableClose()` is invoked by Oracle after the last fetch invocation. The scan context is passed in as a parameter. This routine performs the necessary cleanup operations.

**Figure 13-3** Flowchart of Table Function Row Source Execution

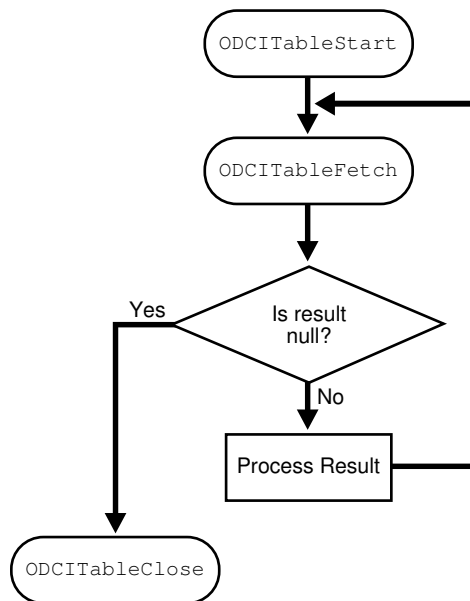

### 13.3.6.5 Describing Returned Data Structures; Describe Method

Sometimes it is not possible to define the structure of the return type from the table function statically. If the shape of the rows is different in different queries, it may depend on the actual arguments with which the table function is invoked. Such table functions can be declared to return `AnyDataSet`. `AnyDataSet` is a generic collection type. It can be used to model any collection (of any element type) and has an associated set of APIs (both PL/SQL and C) that enable you to construct `AnyDataSet` instances and access the elements.

The following example shows a table function declared to return an `AnyDataSet` collection whose structure is not fixed at function creation time:

```
CREATE FUNCTION AnyDocuments(VARCHAR2) RETURN ANYDATASET  
PIPELINED USING DocumentMethods;
```

You can implement a `ODCITableDescribe()` routine to determine the format of the elements in the result collection when the format depends on the actual parameters to the table function. `ODCITableDescribe()` is invoked by Oracle at query compilation time to retrieve the specific type information. Typically, the routine uses the user arguments to determine the shape of the return rows. The format of elements in the returned collection is conveyed to Oracle by returning an instance of `AnyType`.

The `AnyType` instance specifies the actual structure of the returned rows of the specific query. Like `AnyDataSet`, `AnyType` has an associated set of PL/SQL and C interfaces with which to construct and access the metadata information.

The query in [Example 13-11](#), for an `AnyDocuments` function, returns information on either books or magazines.

[Example 13-12](#) is an implementation of the `ODCITableDescribe()` method, which consults the DTD of the XML documents at the specified location to return the appropriate `AnyType` value, either a book or a magazine. The `AnyType` instance is constructed by invoking the constructor APIs with the field name and data type information.

When Oracle invokes `ODCITableDescribe()`, it uses the type information that is returned in the `AnyType` `OUT` argument to resolve references in the command line, such as the reference to the `x.Abstract` attribute in [Example 13-12](#). This functionality is applicable only when the returned type is a named type, and therefore has named attributes.

Another feature of `ODCITableDescribe()` is its ability to describe `SELECT` list parameters, such as using OCI interfaces, when executing a `SELECT *` query. The information retrieved reflects one `SELECT` list item for each top-level attribute of the type returned by `ODCITableDescribe()`.

Because the `ODCITableDescribe()` method is called at compile time, the table function should have at least one argument that has a value at compile time, like a constant. By using the table function with different arguments, you can get different return types from the function, as demonstrated in [Example 13-13](#).

The `ODCITableDescribe()` functionality is available only if the table function is implemented using the interface approach. A native PL/SQL implementation of a table function that returns `ANYDATASET` returns rows whose structure is opaque to the server.

### Example 13-11 Querying for AnyType Data

```
SELECT * FROM
  TABLE(AnyDocuments('http://.../documents.xml')) x
 WHERE x.Abstract like '%internet%';
```

### Example 13-12 Implementing the ODCITableDescribe() Method

```
CREATE TYPE Mag_t AS OBJECT
(
  name VARCHAR2(100),
  publisher VARCHAR2(30),
  abstract VARCHAR2(1000)
);

STATIC FUNCTION ODCITableDescribe(rtype OUT ANYTYPE,
                                  url VARCHAR2)
IS BEGIN
  Contact specified web server and retrieve document...
  Check XML doc schema to determine if books or mags...
  IF books THEN
    rtype=AnyType.AnyTypeGetPersistent('SYS','BOOK_T');
  ELSE
    rtype=AnyType.AnyTypeGetPersistent('SYS','MAG_T');
  END IF;
END;
```

**Example 13-13 Using Functions that Return AnyType**

```
-- Issue a query for books
SELECT x.Name, x.Author
FROM TABLE(AnyDocuments('Books.xml')) x;

-- Issue a query for magazines
SELECT x.Name, x.Publisher
FROM TABLE(AnyDocuments('Magazines.xml')) x;
```

**See Also:**

- [ODCITableDescribe\(\)](#)
- ["Transient and Generic Types"](#) for information on `AnyDataSet` and `AnyType`

### 13.3.6.6 Preparing a Query for Execution; Prepare Method

`ODCITablePrepare()` is invoked at query compilation time. It generates and saves information to decrease the execution time of the query.

If you do not implement `ODCITablePrepare()`, `ODCITableStart()` initializes the context each time it is called. However, if you do implement `ODCITablePrepare()`, it initializes the scan context, which is passed to the `ODCITableStart()` when the query is executed, reducing startup time. In addition, when `ODCITablePrepare()` is implemented, `ODCITableClose()` is called only one time during the query, rather than each time the table function is restarted. This has the following benefits:

- It decreases execution time by reducing the number of calls to `ODCITableClose()`.
- It allows the scan context to be maintained between table function restarts.

`ODCITablePrepare()` also provides projection information to the table function. If you do not implement `ODCITablePrepare()` for table functions that return collections of user-defined types (UDTs), your table function must set every attribute of the UDT of each element, because it has no way of knowing which attributes are used. In contrast, selecting from a regular table fetches only the required columns, which is naturally faster in most cases. However, if you do implement `ODCITablePrepare()`, it can build an array of attribute positions, record the return type information in an argument of type `ODCITabFuncInfo`, and save this information in the scan context, as described in [Example 13-14](#).

Implementing `ODCITablePrepare()` also allows your table function to return transient anonymous types. `ODCITablePrepare()` is called at the end of query compilation, so it can be passed the table descriptor object (TDO) built by the describe method. The describe method can build and return a transient anonymous TDO. Oracle transforms this TDO so that it can be used during query execution, and passes the transformed TDO to the prepare method in the `RetType` attribute. If the describe method returns a TDO for a type that is not anonymous, that TDO is identical to the transformed TDO. Thus, if a table function returns:

- A named collection type, the `RetType` attribute contains the TDO of this type.
- `AnyDataSet`, and the describe method returns a named type, the `RetType` attribute contains the TDO of the named type.

- `AnyDataSet`, and the `describe` method returns an anonymous type, Oracle transforms this type, and `RetType` contains the transformed TDO.

#### Example 13-14 Building an Array of Attribute Positions and Save it in a Scan Context

```
CREATE TYPE SYS.ODCITabFuncInto AS OBJECT (
  Attrs SYS.ODCINumberList,
  RetType SYS.AnyType
);
```

#### See Also:

- [ODCITableClose\(\)](#)
- [ODCITablePrepare\(\)](#)
- [ODCITableStart\(\)](#)

## 13.3.7 Querying Table Functions

Pipelined table functions are used in the `FROM` clause of `SELECT` statements independently from implementation, either in native PL/SQL or through the interface approach. The result rows are retrieved by Oracle iteratively from the table function implementation, as demonstrated in [Example 13-15](#).

However, if the output of a table function is determined solely by the values passed into it as arguments, such that the function always produces exactly the same result value for each respective combination of values passed in, you can declare the function `DETERMINISTIC`, and Oracle automatically buffers rows for it. Note, though, that the database has no way of knowing whether a function marked `DETERMINISTIC` really is `DETERMINISTIC`, and if one is not, results are unpredictable.

#### Example 13-15 Using a Table Function to Iteratively Retrieve Rows

```
SELECT x.Ticker, x.Price
FROM TABLE(StockPivot(CURSOR(SELECT * FROM StockTable))) x
WHERE x.PriceType='C';
```

### 13.3.7.1 Implementing Multiple Calls to Table Functions

Multiple invocations of a table function, either within the same query or in separate queries result in multiple executions of the underlying implementation. That is, in general, there is no buffering or reuse of rows, as demonstrated in [Example 13-16](#).

#### Example 13-16 Using Multiple Invocations of a Table Function

```
SELECT * FROM TABLE(f(...)) t1, TABLE(f(...)) t2
  WHERE t1.id = t2.id;

SELECT * FROM TABLE(f());

SELECT * FROM TABLE(f());
```

### 13.3.7.2 Using PL/SQL REF CURSOR Variables

PL/SQL `REF CURSOR` variables can be defined for queries over table functions, as demonstrated in [Example 13-17](#).

Cursors over table functions have the same fetch semantics as ordinary cursors. `REF CURSOR` assignments based on table functions do not have special semantics.

However, the SQL optimizer does not optimize across PL/SQL statements; therefore, [Example 13-19](#) runs better than [Example 13-18](#).

Additionally, [Example 13-18](#) is slower because of the overhead associated with executing two SQL statements, and because it does not take advantage of efficiencies realized by pipelining results between two functions, as [Example 13-19](#) does.

#### Example 13-17 Defining REF CURSOR Variables for Table Function Queries

```
OPEN c FOR SELECT * FROM TABLE(f(...));
```

#### Example 13-18 Using a REF CURSOR Variable

```
BEGIN
  OPEN r FOR SELECT * FROM TABLE(f(CURSOR(SELECT * FROM tab)));
  SELECT * BULK COLLECT INTO rec_tab FROM TABLE(g(r));
END;
```

#### Example 13-19 Using a REF CURSOR Variable More Effectively

```
SELECT * FROM TABLE(g(CURSOR(SELECT * FROM
  TABLE(f(CURSOR(SELECT * FROM tab))))));
```

## 13.3.8 Performing DML Operations Inside Table Functions

A table function must be declared with the autonomous transaction pragma in order for the function to execute DML statements. This pragma causes the function to execute in an autonomous transaction not shared by other processes, as demonstrated in [Example 13-20](#).

During parallel execution, each instance of the table function creates an independent transaction.

#### Example 13-20 Declaring a Table Function with Autonomous Transaction Pragma

```
CREATE FUNCTION f(p SYS_REFCURSOR) return CollType PIPELINED IS
  PRAGMA AUTONOMOUS_TRANSACTION;
BEGIN ... END;
```

## 13.3.9 Performing DML Operations on Table Functions

Table functions cannot be the target table in `UPDATE`, `INSERT`, or `DELETE` statements. For example, the following statements raise an error:

```
UPDATE F(CURSOR(SELECT * FROM tab)) SET col = value;
INSERT INTO f(...) VALUES ('any', 'thing');
```

However, you can create a view over a table function and use `INSTEAD OF` triggers to update it, as in [Example 13-21](#).

[Example 13-22](#) demonstrates how an `INSTEAD OF` trigger is fired when the user inserts a row into the `BookTable` view:

`INSTEAD OF` triggers can be defined for all DML operations on a view built on a table function.

#### Example 13-21 Creating a View over a Table

```
CREATE VIEW BookTable AS
  SELECT x.Name, x.Author
  FROM TABLE(GetBooks('data.txt')) x;
```

#### Example 13-22 How an INSTEAD OF Trigger is Fired when a Row is Inserted into a View

```
CREATE TRIGGER BookTable_insert
  INSTEAD OF INSERT ON BookTable
  REFERENCING NEW AS n
  FOR EACH ROW
  BEGIN
    ...
  END;
INSERT INTO BookTable VALUES (...);
```

## 13.3.10 Handling Exceptions in Table Functions

Exception handling in table functions works just as it does with ordinary user-defined functions.

Some languages, such as C and Java, provide a mechanism for user-supplied exception handling. If an exception raised within a table function is handled, the table function executes the exception handler and continues processing. Exiting the exception handler takes control to the enclosing scope. If the exception is cleared, execution proceeds normally.

An unhandled exception in a table function causes the parent transaction to roll back.

## 13.4 Parallel Table Functions

For a table function to be executed in parallel, it must have a partitioned input parameter. Parallelism is turned on for a table function if, and only if, both the following conditions are met:

- The function has a `PARALLEL_ENABLE` clause in its declaration.
- Exactly one `REF CURSOR` is specified with a `PARTITION BY` clause.

If the `PARTITION BY` clause is not specified for any input `REF CURSOR` as part of the `PARALLEL_ENABLE` clause, the SQL compiler cannot determine how to partition the data correctly.

### 13.4.1 Inputting Data with Cursor Variables

You can pass a set of rows to a PL/SQL function in a `REF CURSOR` parameter, as demonstrated in [Example 13-23](#).

Results of a subquery can be passed to a function directly, as demonstrated in [Example 13-24](#). The `CURSOR` keyword is required to indicate that the results of a subquery should be passed as a `REF CURSOR` parameter.

**Example 13-23 Passing a Set of Rows to a PL/SQL Function in a REF CURSOR**

```
FUNCTION f(p1 IN SYS_REFCURSOR) RETURN ... ;
```

**Example 13-24 Directly Passing Results from a Subquery to a Function**

```
SELECT * FROM TABLE(f(CURSOR(SELECT empno FROM tab)));
```

### 13.4.1.1 Using Multiple REF CURSOR Input Variables

PL/SQL functions can accept multiple `REF CURSOR` input variables, as demonstrated in [Example 13-25](#).

Function `g` can be invoked as demonstrated in [Example 13-26](#).

You can pass table function return values to other table functions by creating a `REF CURSOR` that iterates over the returned data, as demonstrated in [Example 13-27](#).

**Example 13-25 Passing a Set of Rows to a PL/SQL Function Through REF CURSOR**

```
CREATE FUNCTION g(p1 pkg.refcur_t1, p2 pkg.refcur_t2) RETURN...
  PIPELINED ... ;
```

**Example 13-26 Invoking a Function that Uses Several REF CURSOR Parameters**

```
SELECT * FROM TABLE(g(CURSOR(SELECT empno FROM tab),
  CURSOR(SELECT * FROM emp)));
```

**Example 13-27 Using REF CURSOR to Pass Return Values Between Table Functions**

```
SELECT * FROM TABLE(f(CURSOR(SELECT * FROM TABLE(g(...))));
```

### 13.4.1.2 Explicitly Opening a REF CURSOR for a Query

You can explicitly open a `REF CURSOR` for a query and pass it as a parameter to a table function, as demonstrated in [Example 13-28](#).

**Example 13-28 Explicitly Using a Query REF CURSOR as Table Function Parameter**

```
BEGIN
  OPEN r FOR SELECT * FROM TABLE(f(...));
  -- Must return a single row result set.
  SELECT * INTO rec FROM TABLE(g(r));
END;
```

### 13.4.1.3 PL/SQL REF CURSOR Arguments to Java and C/C++ Functions

Parallel and pipelined table functions may be written in C/C++, Java, or PL/SQL. Unlike PL/SQL, C/C++ and Java do not support the `REF CURSOR` type, but you can still pass a `REF CURSOR` argument to C/C++ and Java functions.

If a table function is implemented as a C callout, then an `IN REF CURSOR` argument passed to the callout is automatically available as an executed OCI statement handle. You can use this handle like any other executed statement handle.

A `REF CURSOR` argument to a callout passed as an `IN OUT` parameter is converted to an executed statement handle on the way in to the callout, and the statement handle is converted back to a `REF CURSOR` on the way out. (The inbound and outbound statement handles may be different.)

If a `REF CURSOR` type is used as an `OUT` argument, or a return type to a call, then the call must return the statement handle, which are converted to a `REF CURSOR` for the caller, as demonstrated in [Example 13-28](#).

If the function is written as a Java call, the `IN REF CURSOR` argument is automatically converted to an instance of the Java `ResultSet` class. The `IN REF CURSOR` to `ResultSet` mapping is available only if you use a fat JDBC driver based on OCI. This mapping is not available for a thin JDBC driver. As with an executed statement handle in a C call, when a `REF CURSOR` is either an `IN OUT` argument, an `OUT` argument, or a return type for the function, a Java `ResultSet` is converted back to a PL/SQL `REF CURSOR` on its way out to the caller.

A predefined weak `REF CURSOR` type, `SYS_REFCURSOR`, is also supported. With `SYS_REFCURSOR`, you do not have to first create a `REF CURSOR` type in a package before you can use it. This weak `REF CURSOR` type can be used in the [ODCItableStart\(\)](#) method, which, as a type method, cannot accept a package type.

To use a strong `REF CURSOR` type, you still must create a PL/SQL package and declare a strong `REF CURSOR` type in it. Also, if you are using a strong `REF CURSOR` type as an argument to a table function, then the actual type of the `REF CURSOR` argument must match the column type, or an error is generated.

To partition a weak `REF CURSOR` argument, you must partition by `ANY`, because a weak `REF CURSOR` argument cannot be partitioned by `RANGE` or `HASH`. Oracle recommends that you not use weak `REF CURSOR` arguments to table functions.

### Example 13-29 Using a REF CURSOR in a Call

```
CREATE OR replace PACKAGE pl AS
  TYPE rc IS REF cursor;
END;

CREATE OR REPLACE LIBRARY MYLIB AS 'mylib.so';

CREATE OR REPLACE FUNCTION MyCallout (stmthp pl.rc)
  RETURN binary_integer AS LANGUAGE C LIBRARY MYLIB
  WITH CONTEXT
  PARAMETERS (context, stmthp ocirefcursor, RETURN sb4);

sb4 MyCallout (OCIExtProcContext *ctx, OCIStmt ** stmthp)
  OCIEnv *envhp;          /* env. handle */
  OCISvcCtx *svchp;      /* service handle */
  OCIError *errhp;       /* error handle */
  OCISession *usrhp;     /* user handle */

  int errnum = 29400;     /* choose some oracle error number */
  char errmsg[512];      /* error message buffer */
  size_t errmsglen;      /* Length of error message */
  OCIDefine *defnlp = (OCIDefine *) 0;
  OCINumber *val=(OCINumber *)0;
```



```

OCINumber *rval = (OCINumber *)0;
sword status = 0;
double num=0;
val = (OCINumber*) OCIEExtProcAllocCallMemory(ctx, sizeof(OCINumber));
/* Get OCI handles */
if (GetHandles(ctx, &envhp, &svchp, &errhp, &usrhp,&rval))
    return -1;
/* Define the fetch buffer */
psdro_checkerr(NULL, errhp, OCIDefineByPos(*stmthp, &defnlp, errhp, (ub4) 1,
                                           (dvoid *) &num, (sb4) sizeof(num),
                                           SFLT_FLT, (dvoid *) 0, (ub2 *)0,
                                           (ub2 *)0, (ub4) OCI_DEFAULT));

/* Fetch loop */
while ((status = OCISmtFetch(*stmthp, errhp, (ub4) 1, (ub4) OCI_FETCH_NEXT,
                            (ub4) OCI_DEFAULT)) == OCI_SUCCESS ||
        status == OCI_SUCCESS_WITH_INFO)
{
    printf("val=%lf\n",num);
}
return 0;
}

```

## 13.4.2 Input Data Partitioning

The table function declaration can specify data partitioning for exactly one `REF CURSOR` parameter, as demonstrated in [Example 13-30](#). The `PARTITION BY` phrase in the `PARALLEL_ENABLE` clause specifies which one of the input cursors to partition, and what columns to use for partitioning.

When explicit column names are specified in the column list, the partitioning method may be either `RANGE` or `HASH`. The input rows are hash- or range-partitioned on the specified columns.

The `ANY` keyword enables you to indicate that the function behavior is independent of the partitioning of the input data. When this keyword is used, the run-time system randomly partitions the data among the slaves. This keyword is appropriate for use with functions that take in one row, manipulate its columns, and generate output row(s) based on the columns of this row only.

To demonstrate, the pivot-like function `StockPivot()` in [Example 13-31](#) takes as input a row of the type `(Ticker varchar(4), OpenPrice number, ClosePrice number)`, and generates rows of the type `(Ticker varchar(4), PriceType varchar(1), Price number)`. Thus, the row `("ORCL", 41, 42)` generates two rows: `("ORCL", "O", 41)` and `("ORCL", "C", 42)`.

You can use directly `TickerTypeSet`, as created in [Example 13-5](#), instead of `rec_tab_type` or define it the same way.

The function `f()` may be used to generate another table from `Stocks` table, as shown in [Example 13-32](#).

If `StockTable` is scanned in parallel and partitioned on `OpenPrice`, then the function `StockPivot()` is combined with the data-flow operator that scans `StockTable` and therefore sees the same partitioning.

If `StockTable` is not partitioned, and the scan on it does not execute in parallel, the `insert into AlternateStockTable` also runs sequentially, as demonstrated in [Example 13-33](#).

If function `g()` runs in parallel and is partitioned by `ANY`, then the parallel insert can belong in the same data-flow operator as `g()`.

Whenever the `ANY` keyword is specified, the data is partitioned randomly among the slaves. This effectively means that the function is executed in the same slave set which does the scan associated with the input parameter.

No redistribution or repartitioning of the data is required here. In the case, when the cursor `p` itself is not parallel-enabled, the incoming data is randomly partitioned on the columns in the column list. The round-robin table queue is used for this partitioning.

If you create an `XMLIndex` index on a partitioned `XMLType` table, or a partitioned table with an `XMLType` column using range, list, or hash partitioning, that index is equipartitioned with the base table.

### Example 13-30 Specifying Data Partitioning for a REF CURSOR Parameter

```
CREATE FUNCTION f(p ref_cursor_type) RETURN rec_tab_type PIPELINED
  PARALLEL_ENABLE(PARTITION p BY [{HASH | RANGE} (column_list) | ANY ]) IS
BEGIN ... END;
```

### Example 13-31 Implementing the StockPivot() Function

```
CREATE FUNCTION StockPivot(p refcur_pkg.refcur_t) RETURN rec_tab_type PIPELINED
  PARALLEL_ENABLE(PARTITION p BY ANY) IS
  ret_rec rec_type;

BEGIN
  FOR rec IN p LOOP
    ret_rec.Ticker := rec.Ticker;
    ret_rec.PriceType := "O";
    ret_rec.Price := rec.OpenPrice;
    PIPE ROW(ret_rec);

    ret_rec.Ticker := rec.Ticker; -- Redundant; not required
    ret_rec.PriceType := "C";
    ret_rec.Price := rec.ClosePrice;
    PIPE ROW ret_rec;
  END LOOP;
  RETURN;
END;
```

### Example 13-32 Using a REF CURSOR to Generate a Table from Another Table

```
INSERT INTO AlternateStockTable
  SELECT * FROM
  TABLE(StockPivot(CURSOR(SELECT * FROM StockTable)));
```

### Example 13-33 Using a REF CURSOR to Scan and Insert

```
CREATE FUNCTION g(p refcur_pkg.refcur_t) RETURN ... PIPELINED
  PARALLEL_ENABLE (PARTITION p BY ANY)
BEGIN
  ...
END;

INSERT INTO AlternateStockTable
  SELECT * FROM TABLE(f(CURSOR(SELECT * FROM Stocks))), TABLE(g(CURSOR( ... )))
  WHERE join_condition;
```

## 13.4.3 Parallel Execution of Leaf-Level Table Functions

Parallel execution of a table function requires a `REF CURSOR` as an input parameter. If the table function does not inherently require a set of rows as input, then you must redesign the function to require a `REF CURSOR` as input.

For example, the following function reads a set of external files in parallel and returns the records they contain. To provide work for a `REF CURSOR`, you might first create a table and populate it with the filenames. A `REF CURSOR` over this table can then be passed as a parameter to the table function `readfiles()`, as demonstrated by [Example 13-34](#).

### Example 13-34 Using a `REF CURSOR` to Read a Set of External Files

```
CREATE TABLE filetab(filename VARCHAR(20));

INSERT INTO filetab VALUES('file0');
INSERT INTO filetab VALUES('file1');
...
INSERT INTO filetab VALUES('fileN');

SELECT * FROM TABLE(readfiles(CURSOR(SELECT filename FROM filetab)));

CREATE FUNCTION readfiles(p pkg.rc_t) RETURN coll_type
  PARALLEL_ENABLE(PARTITION p BY ANY) IS
  ret_rec rec_type;
BEGIN
  FOR rec IN p LOOP
    done := FALSE;
    WHILE (done = FALSE) LOOP
      done := readfilerecord(rec.filename, ret_rec);
      PIPE ROW(ret_rec);
    END LOOP;
  END LOOP;
  RETURN;
END;
```

## 13.5 Input Data Streaming for Table Functions

Data streaming is the manner in which a table function orders or clusters rows that it fetches from cursor arguments. A function can stream its input data in any of the following ways:

- Place no restriction on the ordering of the incoming rows.
- Order them on a particular key column or columns.
- Cluster them on a particular key.

To control the behavior of the input stream, use the syntax in [Example 13-36](#).

Input streaming may be specified for either sequential or parallel execution of a function. If an `ORDER BY` or `CLUSTER BY` clause is not specified, rows are input in a random order. The semantics of `ORDER BY` are different for parallel execution from the semantics of the `ORDER BY` clause in a SQL statement. In a SQL statement, the `ORDER BY` clause globally orders the entire data set. In a table function, the `ORDER BY` clause orders the respective rows local to each instance of the table function running on a slave.

Clustering causes rows that have the same key values to appear next to one another, but it does not otherwise do any ordering of rows.

`expr` should be the `REFCURSOR` received in the function.

**Example 13-35** illustrates the syntax for ordering the input stream. In the example, function `f()` takes in rows of the kind `(Region, Sales)` and returns rows of the form `(Region, AvgSales)`, showing average sales for each region.

## 13.5.1 Setting up the Input Stream

### Example 13-35 Ordering the Input Stream

```
CREATE FUNCTION f(p ref_cursor_type) RETURN tab_rec_type PIPELINED
  CLUSTER p BY (Region)
  PARALLEL_ENABLE(PARTITION p BY HASH(Region)) IS
  ret_rec rec_type;
  cnt number;
  sum number;
BEGIN
  LOOP
    FETCH p INTO rec;
    EXIT WHEN p%NOTFOUND;
    IF (first rec in the group) THEN
      cnt := 1;
      sum := rec.Sales;
    ELSIF (last rec in the group) THEN
      IF (cnt <> 0) THEN
        ret_rec.Region := rec.Region;
        ret_rec.AvgSales := sum/cnt;
        PIPE ROW(ret_rec);
      END IF;
    ELSE
      cnt := cnt + 1;
      sum := sum + rec.Sales;
    END IF;
  END LOOP;
  RETURN;
END
```

### Example 13-36 Controlling Input Data Streaming

```
FUNCTION f(p ref_cursor_type) RETURN tab_rec_type [PIPELINED]
  {[ORDER | CLUSTER] expr BY column_list}
  PARALLEL_ENABLE({PARTITION p BY
    [ANY | {HASH | RANGE} column_list]})
IS
BEGIN
  ...
END;
```

## 13.5.2 Parallel Execution: Partitioning and Clustering

Partitioning and clustering are easily confused, but they do different things. Sometimes partitioning can be sufficient without clustering in parallel execution.

Consider a function `SmallAggr` that performs in-memory aggregation of salary for each `department_id`, where `department_id` can be either 1, 2, or 3. The input rows to the function can be partitioned by `HASH` on `department_id` so that all rows with `department_id`

equal to 1 go to one slave, all rows with `department_id` equal to 2 go to another slave, and so on.

The input rows do not have to be clustered on `department_id` to perform the aggregation in the function. Each slave could have a 1 by 3 array `SmallSum[1..3]`, in which the aggregate sum for each `department_id` is added in memory into `SmallSum[department_id]`. On the other hand, if the number of unique values of `department_id` were very large, you would want to use clustering to compute department aggregates and write them to disk one `department_id` at a time.

## 13.6 Creating Domain Indexes in Parallel

Creating a domain index can be a lengthy process because of the large amount of data that a domain index typically handles. You can exploit the parallel-processing capabilities of table functions to alleviate this bottleneck by using table functions to create domain indexes in parallel.

Typically, the `ODCIIndexCreate()` routine performs the following steps:

1. Creates tables for storing the index data
2. Fetches the relevant data, such as `keycols` and `rowid`, from the base table, transforms it, and inserts relevant transformed data into the table created for storing the index data.
3. Builds secondary indexes on the tables that store the index data, for faster access at query time.

Step 2 is the bottleneck in creating domain indexes. You can speed up this step by encapsulating these operations in a parallel table function and invoking the function from the `ODCIIndexCreate()` function. In [Example 13-37](#), a table function `IndexLoad()` is defined to do just that.

where `p` is a cursor of the form:

```
SELECT /*+ PARALLEL (base_table, par_degree) */ keycols ,rowid
FROM base_table
```

The `par_degree` value can be explicitly specified; otherwise, it is derived from the parallel degree of the base table.

The function `IndexMerge()`, defined in [Example 13-38](#), is needed to merge the results from the several instances of `IndexLoad()`.

The new steps in `ODCIIndexCreate()` would be:

1. Create metadata structures for the index (tables to store the index data).
2. Explicitly commit the transaction so that the `IndexLoad()` function can access the committed data.
3. Invoke `IndexLoad()` in parallel, as shown in the following code example.

Invoking the Merging of Parallel Domain Index Loads

```
status := ODCIIndexMerge(CURSOR(
  SELECT * FROM TABLE(ODCIIndexLoad(ia, parms, CURSOR(
    SELECT key_cols, ROWID FROM basetable)))))
```

4. Create secondary index structures.

 **See Also:**  
[ODCIIndexCreate\(\)](#)

## 13.6.1 Loading Domain Indexes

The formation of secondary indexes is very time consuming, and Oracle recommends that you implement parallel loading of domain index, as illustrated in the “Loading a Domain Index in Parallel” section, and subsequently recombine them as shown in “Merging the Results from Parallel Domain Index Loads” example.

### Example 13-37 Loading a Domain Index in Parallel

```
CREATE FUNCTION IndexLoad(ia ODCIIndexInfo, parms VARCHAR2,
                          p refcur-type)
RETURN status_code_type
PARALLEL_ENABLE(PARTITION p BY ANY)
PRAGMA AUTONOMOUS_TRANSACTION
IS
BEGIN
  FOR rec IN p LOOP
    - process each rec and determine the index entry
    - derive name of index storage table from parameter ia
    - insert into table created in ODCIIndexCreate
  END LOOP;
  COMMIT; -- explicitly commit the autonomous txn
  RETURN ODCIConst.Success;
END;
```

### Example 13-38 Merging the Results from Parallel Domain Index Loads

```
CREATE FUNCTION IndexMerge(p refcur-type)
RETURN NUMBER
IS
BEGIN
  FOR rec IN p LOOP
    IF (rec != ODCIConst.Success)
      RETURN Error;
  END LOOP;
  RETURN Success;
END;
```

## 13.7 Transient and Generic Types

Oracle has three special SQL data types that enable you to dynamically encapsulate and access type descriptions, data instances, and sets of data instances of any other SQL type, including object and collection types. You can also use these three special types to create anonymous, or unnamed, types, including anonymous collection types. See [Table 13-1](#).

The three SQL types are implemented as opaque types; the internal structure of these types is not known to the database: their data can be queried only by implementing functions, typically 3GL routines. Oracle provides both an OCI and a PL/SQL API for implementing such functions.

**Table 13-1 Generic SQL Types**

Type	Description
<code>SYS.ANYTYPE</code>	<p>A type description type. A <code>SYS.ANYTYPE</code> can contain a type description of any SQL type, named or unnamed, including object types and collection types.</p> <p>An <code>ANYTYPE</code> can contain a type description of a persistent type, but an <code>ANYTYPE</code> itself is transient: the value in an <code>ANYTYPE</code> itself is not automatically stored in the database. To create a persistent type, use a <code>CREATE TYPE</code> statement from SQL.</p>
<code>SYS.ANYDATA</code>	<p>A self-describing data instance type. A <code>SYS.ANYDATA</code> contains an instance of a given type, with data, plus a description of the type. In this sense, a <code>SYS.ANYDATA</code> is self-describing. An <code>ANYDATA</code> can be persistently stored in the database.</p>
<code>SYS.ANYDATASET</code>	<p>A self-describing data set type. A <code>SYS.ANYDATASET</code> type contains a description of a given type plus a set of data instances of that type. An <code>ANYDATASET</code> can be persistently stored in the database.</p>

Each of these three types can be used with any built-in type native to the database with object types and collection types, both named and unnamed. The types provide a generic way to work dynamically with type descriptions, lone instances, and sets of instances of other types. Using the APIs, you can create a transient `ANYTYPE` description of any kind of type. Similarly, you can create or convert (cast) a data value of any SQL type to an `ANYDATA` and can convert an `ANYDATA` (back) to a SQL type. And similarly again with sets of values and `ANYDATASET`.

The generic types simplify working with stored procedures. You can use the generic types to encapsulate descriptions and data of standard types and pass the encapsulated information into parameters of the generic types. In the body of the procedure, you can detail how to handle the encapsulated data and type descriptions of whatever type.

You can also store encapsulated data of a variety of underlying types in one table column of type `ANYDATA` or `ANYDATASET`. For example, you can use `ANYDATA` with advanced queuing to model queues of heterogeneous types of data. You can query the data of the underlying data types like any other data.

Note, however, that `ANYDATA` and `ANYDATASET` objects that were created on a transient type, such as unnamed type constructed through an `ANYTYPE` API, cannot be stored persistently in an `ANYDATA` or `ANYDATASET` table column.

Corresponding to the three generic SQL types are three OCI types that model them. Each has a set of functions for creating and accessing the respective type:

- `OCIType`, corresponding to `SYS.ANYTYPE`
- `OCIAnyData`, corresponding to `SYS.ANYDATA`
- `OCIAnyDataSet`, corresponding to `SYS.ANYDATASET`

 **See Also:**

- *Oracle Call Interface Programmer's Guide* for the `OCIType`, `OCIAnyData`, and `OCIAnyDataSet` APIs and details on how to use them
- *Oracle Database PL/SQL Packages and Types Reference* for information about the interfaces to the `ANYTYPE`, `ANYDATA`, and `ANYDATASET` types and about the `DBMS_TYPES` package, which defines constants for built-in and user-defined types, for use with `ANYTYPE`, `ANYDATA`, and `ANYDATASET`
- *Oracle Database Object-Relational Developer's Guide* for definition of generic, transient, and opaque types.



# 14

## Designing Data Cartridges

There are various items for you to consider when designing data cartridges.

### 14.1 Choosing the Programming Language

You can implement methods for object types in PL/SQL, C/C++, or Java. PL/SQL and Java methods run in the address space of the server. C/C++ methods are dispatched as external procedures and run outside the address space of the server.

The best implementation choice depends on the situation. Here are some guidelines:

- A callout involving C or C++ is generally fastest if the processing is substantially CPU-bound. However, callouts incur the cost of dispatch, which might be important for small amounts of processing in C/C++.
- PL/SQL is most efficient for methods that are not computation-intensive. The other implementation options are typically favored over PL/SQL if you have a large body of code implemented in another language, and it can be used by the data cartridge, or if you must perform extensive computations.
- Java is a relatively open implementation choice. Although Java is usually interpreted, high-performance applications might benefit from pre-compilation of methods or just-in-time compilers.

### 14.2 Invoker's Rights

The invoker's rights mechanism lets a function execute with the privileges of the invoker. Thus, a cartridge can live within a schema dedicated to it, which can be used by other schemas without privileges for operating on objects in the schema where the cartridge resides.

### 14.3 Callouts and LOBs

When using LOBS with callouts, consider the following:

- It can be to your advantage to code your callout so that it is independent of LOB types (BFILE/BLOB).
- The PL/SQL layer of your cartridge can open your BFILE so that no BFILE-specific logic is required in your callout (other than error recovery from OCILOB calls that do not operate on BFILES).
- With the advent of temporary LOBS, you must be aware of the deep copy that can occur when assignments and calls are done with temporary LOBS. Use NOCOPY (BY REFERENCE) on BLOB parameters as appropriate.

## 14.4 Saving and Passing State

Traditionally, external procedures have a state-less model. All statement handles opened during the invocation of an external procedure are closed implicitly at the end of the call.

Oracle Database allows state information, such as OCI statement handles and associated state in the database, to be saved and used across invocations of external procedures in a session. By default, cartridges are stateless; however, you can use `OCIMemory` services and `OCIContext` services with `OCI_DURATION_SESSION` or other appropriate duration to save state. Statement handles created in one external procedure invocation can be re-used in another. As the data cartridge developer, you must explicitly free these handles. Oracle recommends that you do this as soon as the statement handle is no longer needed. All state maintained for the statement in the OCI handles and in the database is freed as a result. This helps to improve the scalability of your data cartridge.



### See Also:

*Oracle Database PL/SQL Language Reference*

## 14.5 Designing Indexes

Consider some factors that guide optimal design of indexes for your data cartridge.

### 14.5.1 Domain Index Performance

Creating a domain index is not always the best course. If you decide to create a domain index, keep the following factors in mind:

- For complex domain indexes, the functional implementation works better with small data size and when results are a large percentage of the total data size.
- Judicious use of the extensible optimizer can improve performance.

### 14.5.2 Domain Index Component Names

Naming internal components for a domain index implementation can be an issue. Names of internal data objects are typically based on names you provide for table and indexes. The problem is that the derived names for the internal objects must not conflict with any other user-defined object or system object. To avoid this problem, develop some policy that restricts names, or implement some metadata management scheme to avoid errors during `DROP`, `CREATE`, and so on.

### 14.5.3 When to Use Index-Organized Tables

You can create secondary indexes on IOT because using them is more efficient than storing data in a table and a separate index, particularly if most of your data is in the index. This offers a big advantage if you are accessing the data in multiple ways. Note that before the Oracle9i release, you could create only one index on IOTs.

## 14.5.4 Storing Index Structures in LOBs

Index structures can be stored in `LOBs`, but take care to tune the `LOB` for best performance. If you are accessing a particular `LOB` frequently, create your table with the `CACHE` option and place the `LOB` index in a separate tablespace. If you are updating a `LOB` frequently, `TURN OFF LOGGING` and read/write in multiples of `CHUNK` size. If you are accessing a particular portion of a `LOB` frequently, buffer your reads/writes using `LOB` buffering or your own buffering scheme.

## 14.5.5 External Index Structures

With the extensible indexing framework, the meaning and representation of a user-defined index is left to the cartridge developer. Oracle provides basic index implementations such as `IOTs`. In certain cases, binary or character `LOBs` can also be used to store complex index structures. `IOTs`, `BLOBs` and `CLOBs` all live within the database. In addition to them, you may also store a user-defined index as a structure external to the database, for example in a `BFILE`.

The external index structure gives you the most flexibility in representing your index. An external index structure is particularly useful if you have invested in the development of in-memory indexing structures. For example, an operating system file may store index data, which is read into a memory mapped file at run time. Such a case can be handled as a `BFILE` in the external index routines.

External index structures may also provide superior performance, although this gain comes at some cost. Index structures external to the database do not participate in the transaction semantics of the database, which, in the case of index structures inside the database, make data and concomitant index updates atomic. This means that if an update to the data causes an update for the external index to be invoked through the extensible indexing interface, failures can cause the data updates to be rolled back but not the index updates. The database can only roll back what is internal to it: external index structures cannot be rolled back in synchronization with a database rollback. External index structures are perhaps most useful for read-only access. Their semantics become complex if updates to data are involved.

## 14.5.6 Multi-Row Fetch

When the `ODCIIndexFetch()` routine is called, the rowids of all the rows that satisfy the operator predicate are returned. The maximum number of rows that can be returned by the `ODCIIndexFetch()` routine is `nrows` (`nrows` being an argument to the `ODCIIndexFetch()` routine). The value of `nrows` is decided by Oracle based on some internal factors. If you have a better idea of the number of rows that ought to be returned to achieve optimal query performance, you can determine that this number of rows is returned in the `ODCIRidList` `VARRAY` instead of `nrows`. Note that the number of values in the `ODCIRidList` must be less than or equal to `nrows`.

As the cartridge designer, you are in the best position to make a judgement regarding the number of rows to be returned. For example, if in the index 1500 rowids are stored together, and `nrows = 2000`, then it may be optimal to return 1500 rows instead of 2000 rows. Otherwise, the user would have to retrieve 3000 rowids, return 2000 of them, and note which 1000 rowids were not returned.

If you do not have any specific optimization in mind, you can use the value of `nrows` to determine the number of rows to be returned. Currently the value of `nrows` has been set to 2000.

If you implement indexes that use callouts, use `multirow fetch` to fetch the largest number of rows back to the server. This offsets the cost of making the callout.



**See Also:**

[ODCIIndexFetch\(\)](#)

## 14.6 Designing Operators

All domain indexes should contain both indexed and functional implementations of operators, in case the optimizer chooses not to use the indexed implementation. You can, however, use the indexing structures to produce the functional result.

## 14.7 Designing for the Extensible Optimizer

Data cartridges can be more efficient if they are designed with the extensible optimizer in mind.

### 14.7.1 Weighing Cost and Selectivity

When estimating cost, Oracle considers the costs associated with CPU, I/O, and Network.

### 14.7.2 Cost for functions

You can determine the cost of executing a C function using common profilers or tools. For SQL queries, an explain plan of the query gives a rough estimate of the cost of the query. In addition, the `tkprof` utility helps you gather information about the CPU and the I/O cost involved in the operation. You can also determine the cost of executing a callout by using it in a SQL query which "selects from dual" and then estimating its cost using `tkprof`.

#### 14.7.2.1 Selectivity for Functions

The selectivity of a predicate is the number of rows returned by the predicate divided by the total number of rows in the tables. Selectivity refers to the fraction of rows of the table returned by the predicate.

The selectivity function should use the statistics collected for the table to determine what percentage of rows of the table the predicate returns with the given list of arguments. For example, to compute the selectivity of a predicate `IMAGE_GREATER_THAN (Image SelectedImage)` which determines the images that are greater than the `Image SelectedImage`, you might use a histogram of the sizes of the images in the database to compute the selectivity.

Statistics can affect the calculation of selectivity for predicates and the cost of domain indexes.

### 14.7.2.2 Statistics for Tables

The statistics collected for a table can affect the computation of selectivity of a predicate. Thus, statistics that help the user make a better judgement about the selectivity of a predicate should be collected for tables and columns. Knowing the predicates that can operate on the data is helpful in determining what statistics to collect.

For example, in a spatial domain the average, minimum, and maximum number of elements in a `VARRAY` that contains the nodes of the spatial objects is a useful statistic to collect.

### 14.7.2.3 Statistics for Indexes

When a domain index is analyzed, statistics for the underlying objects that constitute the domain index should be analyzed. For example, if the domain index is composed of tables, the statistics collection function should analyze the tables when the domain index is analyzed. The cost of accessing the domain index can be influenced by the statistics that have been collected for the index. For instance, the cost of accessing a domain index could be approximated as the selectivity times the total number of data blocks in the various tables being accessed when the domain index is accessed.

To define cost, selectivity and statistics functions accurately requires a good understanding of the domain. The preceding guidelines are meant to help you understand some issues you must take into account while working on the cost, selectivity and statistics functions. In general it may be a good idea to start by using the default cost and selectivity, and observing how queries of interest behave.

## 14.8 Designing for Maintenance

When you design a data cartridge, keep in mind the issues regarding maintenance.

In particular, if your cartridge maintains a large number of objects, views, tables, and so on, consider making a metadata table to maintain the relationships among the objects for the user. This reduces the complexity of developing and maintaining the cartridge when it is in use.

## 14.9 Enabling Cartridge Installation

- Include a `README` with your cartridge to tell users how to install the cartridge.
- Make the cartridge installable in one step in the database, if possible, such as in `sqlplus @imginst`.
- Tell users how to start the `listener` if you are using callouts.
- Tell users how to setup `extproc`. Most users have never heard of `extproc` and many users have never set up a listener. This is the primary problem when deploying cartridges.
- With the Oracle Software Packager, you can easily create custom SQL install scripts using the `instantiate_file` action. This feature lets you substitute variables in your files when they are installed and it leaves your user with scripts and files that are customized for their installation.

 **See Also:**

*Oracle Database Advanced Application Developer's Guide* for information on setting up the `listener` and `extproc`

## 14.10 Designing for Portability

To make your data cartridge more portable, consider the following:

- Use the data types in `oratypes.h`.
- Use OCI calls where ever possible.
- Use the switches that enforce ANSI C conformance when possible.
- Use ANSI C function prototypes.
- Build and test on your target platforms as early in your development cycle as possible. This helps you locate platform-specific code and provides the maximum amount of time to redesign.

Portability is reduced by:

- Storing endian (big/little) specific data
- Storing floating point data (IEEE/VAX/other)
- Operating system-specific calls (if you must use them, isolate them in a layer specific to the operating system; however, if the calls you require are not in the OCI, and also are not in POSIX, then you are likely to encounter intractable problems)
- Implicitly casting `int` as `size_t` on a 64-bit platform

# Part III

## Scenarios and Examples

Consider the following examples that illustrate the techniques described in [Building Data Cartridges](#):

- [Power Demand Cartridge Example](#)
- [PSBTREE: Extensible Indexing Example](#)
- [Pipelined Table Functions: Interface Approach Example](#)

# 15

## Power Demand Cartridge Example

The power demand cartridge in this example includes a user-defined object type, extensible indexing, and optimization. The entire cartridge definition is available online in file `extdemo1.sql` in the Oracle demo directory.

### See Also:

- [Building Domain Indexes](#) for information about extensible query optimization
- [Using Extensible Optimizer](#) for information about extensible indexing
- [Using Cartridge Services](#) for information about cartridge services

### 15.1 Feature Requirements

A power utility, *Power-To-The-People*, develops a sophisticated model to decide how to deploy its resources. The region served by the utility is represented by a grid laid over a geographic area. This grid is illustrated in [Figure 15-1](#).

**Figure 15-1** Region Served by the Power Utility

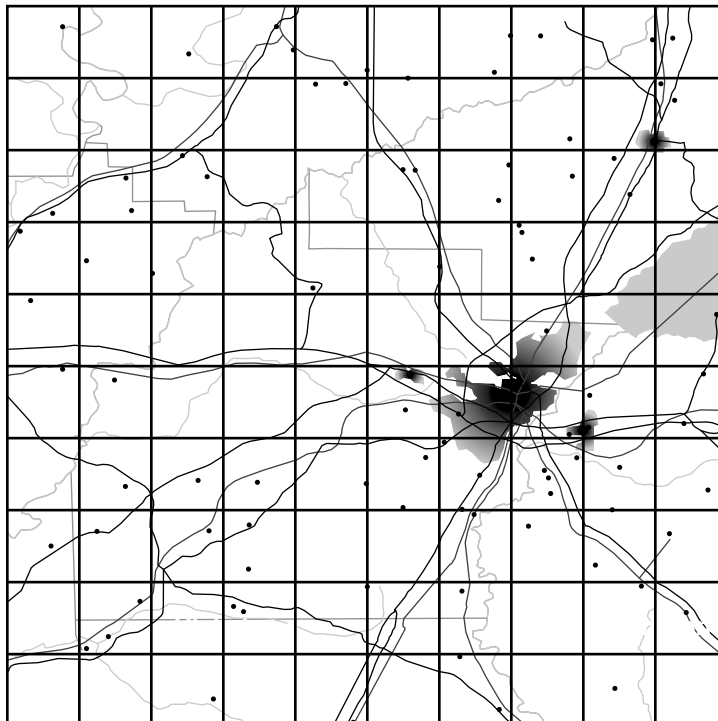



This region may be surrounded by other regions some of whose power needs are supplied by other utilities. As pictured, every region is composed of geographic quadrants, called cells, on a 10x10 grid. There are several ways of identifying cells — by spatial coordinates (longitude/latitude), by a matrix numbering (1,1; 1,2;...), and by numbering them sequentially, as illustrated in [Figure 15-2](#).

**Figure 15-2 Regional Grid Cells in Numbered Sequence**

1	2	3	4	5	6	7	8	9	10
11	12	13	14	15	16	17	18	19	20
21	22	23	24	25	26	27	28	29	30
31	32	33	34	35	36	37	38	39	40
41	42	43	44	45	46	47	48	49	50
51	52	53	54	55	56	57	58	59	60
61	62	63	64	65	66	67	68	69	70
71	72	73	74	75	76	77	78	79	80
81	82	83	84	85	86	87	88	89	90
91	92	93	94	95	96	97	98	99	100

Within the area represented by each cell, the power used by consumers in that area is recorded each hour. For example, the power demand readings for a particular hour might be represented by [Table 15-1](#) (cells here represented on a matrix).

**Table 15-1 Sample Power Demand Readings for an Hour**

-	1	2	3	4	5	6	7	8	9	10
1	23	21	25	23	24	25	27	32	31	30
2	33	32	31	33	34	32	23	22	21	34
3	45	44	43	33	44	43	42	41	45	46
4	44	45	45	43	42	26	19	44	33	43
5	45	44	43	42	41	44	45	46	47	44
6	43	45	98	55	54	43	44	33	34	44
7	33	45	44	43	33	44	34	55	46	34
8	87	34	33	32	31	34	35	38	33	39
9	30	40	43	42	33	43	34	32	34	46

**Table 15-1 (Cont.) Sample Power Demand Readings for an Hour**

-	1	2	3	4	5	6	7	8	9	10
10	43	42	34	12	43	45	48	45	43	32

The power stations also receives reports from two other sources:

- *Sensors* on the ground provide temperature readings for every cell  
By analyzing the correlation between historical power demand from cells and the temperature readings for those regions, the utility is able to determine with a close approximation the expected demand, given specific temperatures.
- *Satellite cameras* provide images regarding current conditions that are converted into grayscale images that match the grid illustrated in [Figure 15-3](#).

**Figure 15-3 Grayscale Representation of Satellite Image**

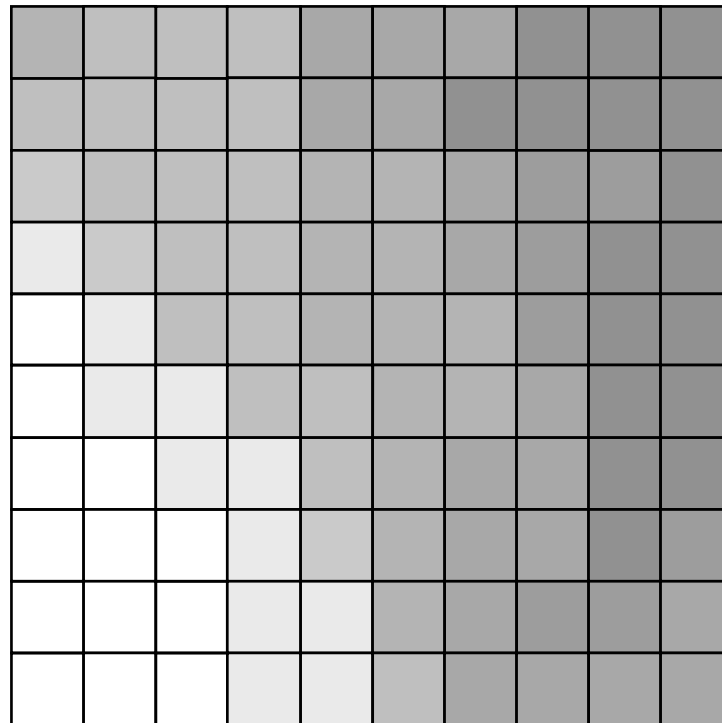

These images are designed so that lighter is colder. Thus, the image shows a cold front moving into the region from the south-west. By correlating the data provided by the grayscale images with temperature readings taken at the same time, the utility has been able to determine what the power demand is given weather conditions viewed from the stratosphere.

The reason that this is important is that a crucial part of this modeling has to do with noting the rapidity and degree of change in the incoming reports as weather changes and power is deployed. The following diagram shows same cold front at a second recording, illustrated in [Figure 15-4](#).

**Figure 15-4** Grayscale Representation of Weather Conditions at Second Recording

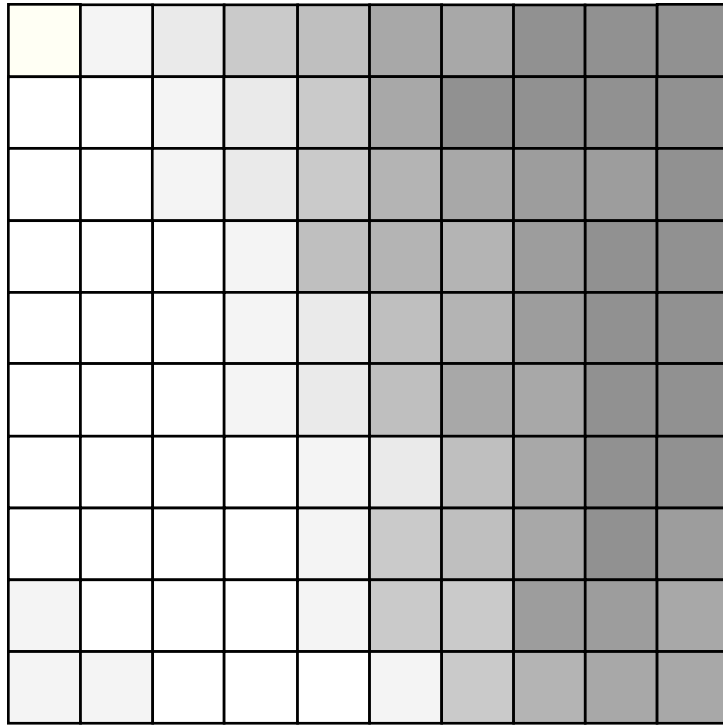

By analyzing the extent and speed of the cold front, the utility is able to project what the conditions are likely to be in the short and medium term, as in [Figure 15-5](#).

**Figure 15-5 Grayscale Representation of Conditions as Projected**

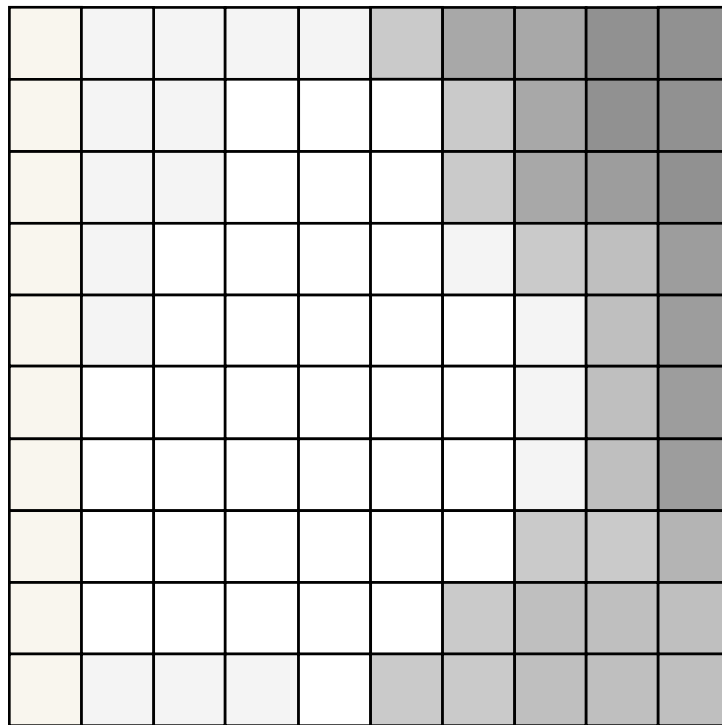

By combining the data about these conditions and other anomalous situations (such as the failure of a substation), the utility must be able to organize the most optimal deployment of its resources. [Figure 15-6](#) reflects the distribution of substations across the region.

**Figure 15-6** Distribution of Power Stations Across the Region

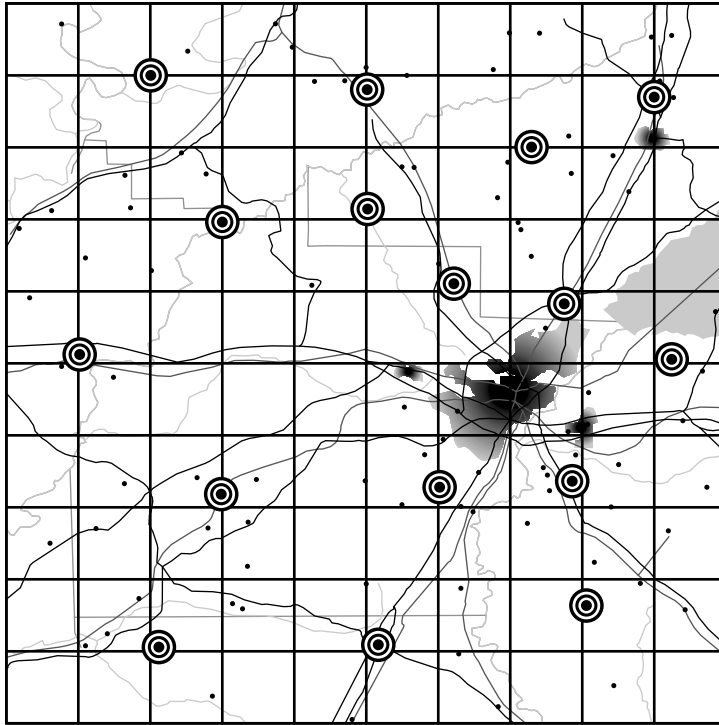

The distribution of power stations means that the utility can redirect its deployment of electricity to the areas of greatest need. [Figure 15-7](#) gives a pictorial representation of the overlap between three stations.

**Figure 15-7** Areas Served by Three Power Stations

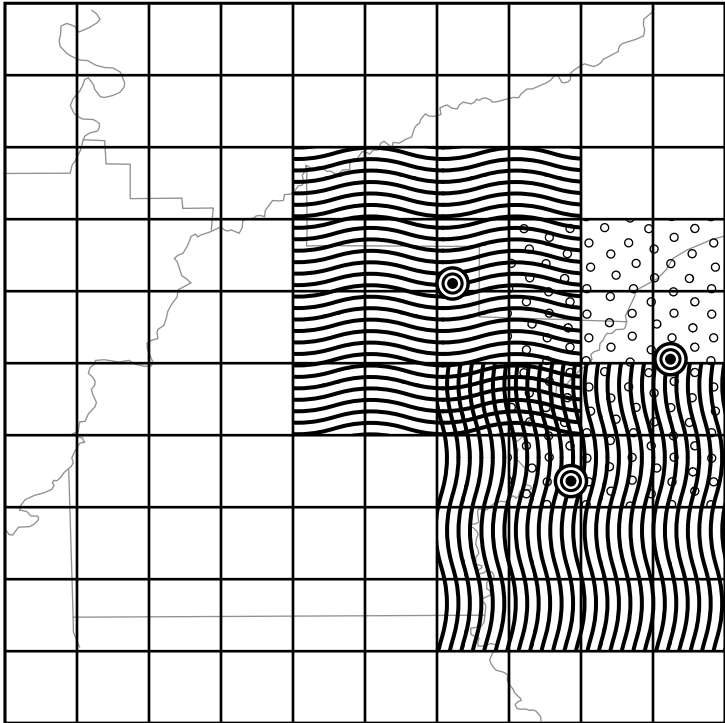

Depending on fluctuating requirements, the utility must be able to decide how to deploy its resources, and even whether to purchase power from another utility in the event of shortfall.

## 15.2 Modeling the Application

Consider a technical and business scenario for modeling an application. The Class Diagram in [Figure 15-8](#) describes the application objects using the Unified Modelling Language (UML) notation.

Figure 15-8 Application Object Model of the Power Demand Cartridge

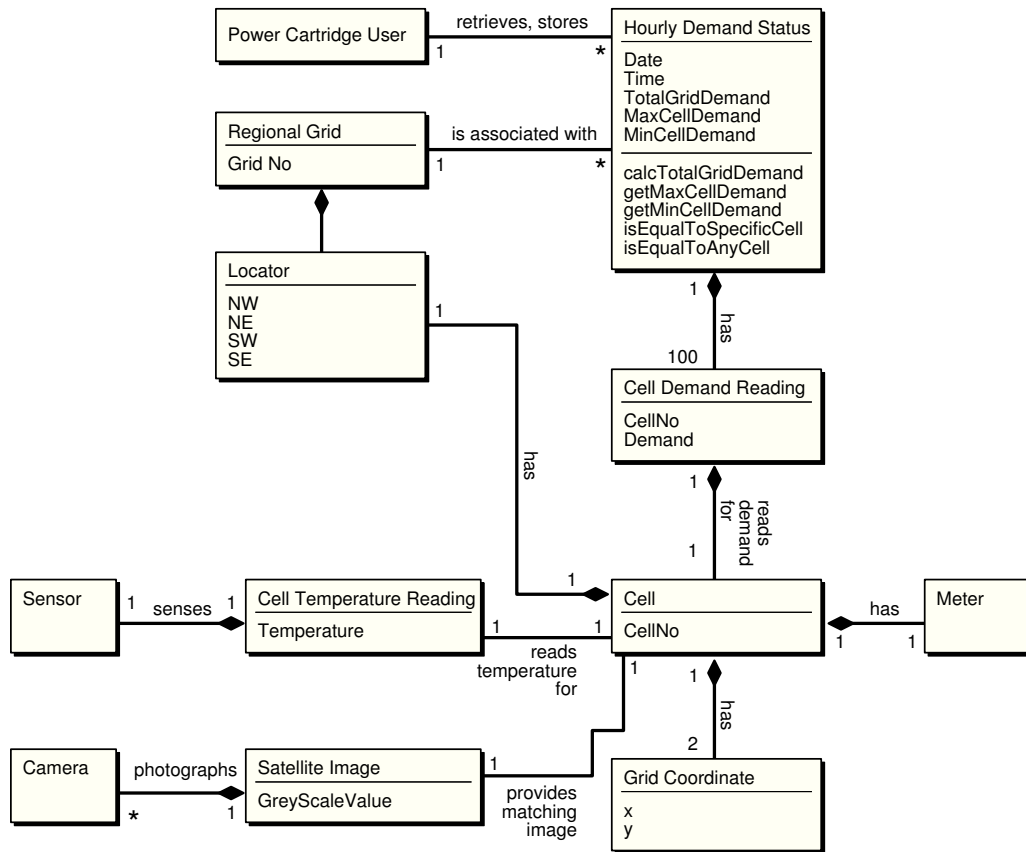

## 15.2.1 Sample Queries

Modelling the application in this way makes it possible the following specific queries:

- Find the cell (geographic quadrant) with the highest demand for a specified time-period.
- Find the time-period with the highest total demand.
- Find all cells where demand is greater than some specified value.
- Find any cell at any time where the demand equals some specified value.
- Find any time period for which 3 or more cells have a demand greater than some specified.
- Find the time-period for which there was the greatest disparity (difference) between the cell with the minimum demand and the cell with the maximum demand.
- Find the times for which 10 or more cells had demand not less than some specified value.
- Find the times for which the average cell demand was greater than some specified value.

Note that it is assumed that the average is easily computable through  $TotalPowerDemand/100$ .

- Find the time-periods for which the median cell demand was greater than some specified value.  
Note that we assume that the median value is not easily computable.
- Find all time-periods for which the total demand rose 10 percent or more over the preceding time's total demand.

These queries are, of course, only a short list of the possible information that could be gleaned from the system. For instance, it is obvious that the developer of such an application would want to build queries that are based on the information derived from prior queries:

- What is the percentage change in demand for a particular cell as compared to a previous time-period?
- Which cells demonstrate rapid increase or decrease in demand measured as percentages that are greater or less than specified values?

Figure 15-9 describes and illustrates the Power Demand cartridge, as implemented.

**Figure 15-9 Implementation Model of the Power Demand Cartridge**

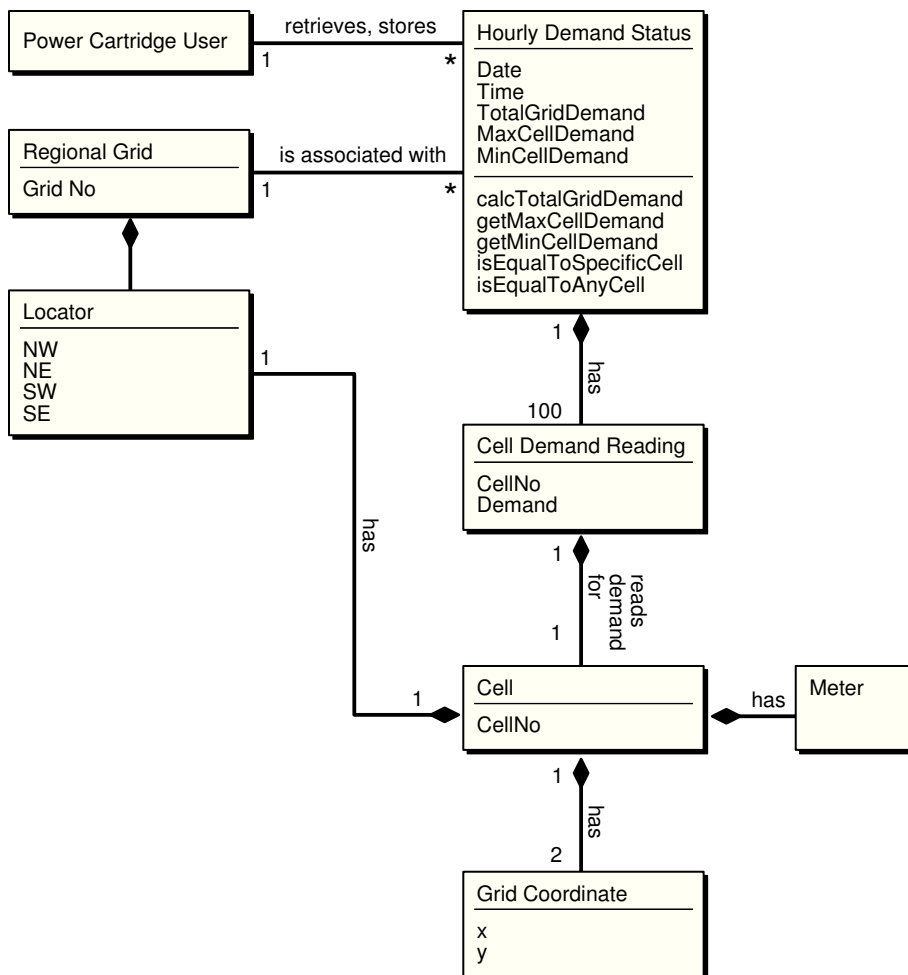

The utility receives ongoing reports from weather centers about current conditions and from power stations about ongoing power utilization for specific geographical areas



(represented by cells on a 10x10 grid). It then compares this information to historical data so it may predict demand for power in the different geographic areas for given time periods.

Each service area for the utility is considered as a 10x10 grid of cells, where each cell's boundaries are associated with spatial coordinates (longitude/latitude). The geographical areas represented by the cells can be uniform or can have different shapes and sizes. Within the area represented by each cell, the power used by consumers in that area is recorded each hour. For example, the power demand readings for a particular hour might be represented by [Table 15-2](#).

**Table 15-2 Sample Power Demand Readings for an Hour**

-	1	2	3	4	5	6	7	8	9	10
1	23	21	25	23	24	25	27	32	31	30
2	33	32	31	33	34	32	23	22	21	34
3	45	44	43	33	44	43	42	41	45	46
4	44	45	45	43	42	26	19	44	33	43
5	45	44	43	42	41	44	45	46	47	44
6	43	45	98	55	54	43	44	33	34	44
7	33	45	44	43	33	44	34	55	46	34
8	87	34	33	32	31	34	35	38	33	39
9	30	40	43	42	33	43	34	32	34	46
10	43	42	34	12	43	45	48	45	43	32

The numbers in each cell reflect power demand (in some unit of measurement determined by the electric utility) for the hour for that area. For example, the demand for the first cell (1,1) was 23, the demand for the second cell (1,2) was 21, and so on. The demand for the last cell (10, 10) was 32.

The utility uses this data for many monitoring and analytical applications. Readings for individual cells are monitored for unusual surges or decreases in demand. For example, the readings of 98 for (6,3) and 87 for (8,1) might be unusually high, and the readings of 19 for (4,7) and 12 for (10,4) might be unusually low. Trends are also analyzed, such as significant increases or decreases in demand for each neighborhood, for each station, and overall, over time.

## 15.3 Queries and Extensible Indexing

Consider the kinds of queries that benefit from domain indexes. The choice to use extensible indexing depends on whether queries run as efficiently with a standard Oracle index, or with no index at all.

### 15.3.1 Queries Not Benefiting from Extensible Indexing

A query does not require a domain index if both of the following are true:

- The desired information can be made an attribute (column) of the table and a standard index can be defined on that column.

- The operations in queries on the data are limited to those operations supported by the standard index, such as `equals`, `lessthan`, `greaterthan`, `max`, and `min` for a b-tree index.

In the `PowerDemand_Typ` object type cartridge example, the values for three columns (`TotGridDemand`, `MaxCellDemand`, and `MinCellDemand`) are set by functions, after which the values do not change. (For example, the total grid power demand for 13:00 on 01-Jan-1998 does not change after it has been computed.) For queries that use these columns, a standard b-tree index on each column is sufficient and recommended for operations like `equals`, `lessthan`, `greaterthan`, `max`, and `min`.

Examples of queries that would not benefit from extensible indexing (using the power demand cartridge) include:

- Find the cell with the highest power demand for a specific time.
- Find the time when the total grid power demand was highest.
- Find all cells where the power demand is greater than a specified value.
- Find the times for which the average cell demand or the median cell demand was greater than a specified value.

To make this query run efficiently, define two additional columns in the `PowerDemand_Typ` object type (`AverageCellDemand` and `MedianCellDemand`), and create functions to set the values of these columns. (For example, `AverageCellDemand` is `TotGridDemand` divided by 100.) Then, create b-tree indexes on the `AverageCellDemand` and `MedianCellDemand` columns.

## 15.3.2 Queries Benefiting from Extensible Indexing

A query benefits from a domain index if the data being queried against cannot be made a simple attribute of a table or if the operation to be performed on the data is not one of the standard operations supported by Oracle indexes.

Examples of queries that would benefit from extensible indexing (using the power demand cartridge) include:

- Find the first cell for a specified time where the power demand was equal to a specified value.  
By asking for the first cell, the query goes beyond a simple true-false check (such as finding out whether *any* cell for a specified time had a demand equal to a specified value), and thus benefits from a domain index.
- Find the time for which there was the greatest disparity, or difference between the cell with the minimum demand and the cell with the maximum demand.
- Find all times for which 3 or more cells had a demand greater than a specified value.
- Find all times for which 10 or more cells had a demand not less than a specified value.
- Find all times for which the total grid demand rose 10 percent or more over the preceding time's total grid demand.

## 15.4 Creating the Domain Index

Consider the parts of the power demand cartridge as they relate to extensible indexing. Explanatory text and code segments are mixed.

The entire cartridge definition is available online as `extdemo1.sql` in the standard Oracle demo directory (location is platform-dependent).

### 15.4.1 Creating the Schema to Own the Index

Before you create a domain index, create a database user, or schema, to own the index. In the power demand example, the user `PowerCartUser` is created and granted the appropriate privileges. All database structures related to the cartridge are created under this user (that is, while the cartridge developer or DBA is connected to the database as `PowerCartUser`), as demonstrated in [Example 15-1](#).

#### Example 15-1 Creating a Database User for the Power Demand Cartridge

```
set echo on
connect sys/knl_test7 as sysdba;
drop user PowerCartUser cascade;
create user PowerCartUser identified by PowerCartUser;

-----
-- INITIAL SET-UP
-----

-- grant privileges --
grant connect, resource to PowerCartUser;
grant create operator to PowerCartUser;
grant create indextype to PowerCartUser;
grant create table to PowerCartUser;
```

### 15.4.2 Creating the Object Types

The object type `PowerDemand_Typ` stores the hourly power grid readings. This type is used to define a column in the table in which the readings are stored.

First, three types are defined for later use, as demonstrated in [Example 15-2](#).

- `PowerGrid_Typ` defines the cells in `PowerDemand_Typ`.
- `NumTab_Typ` is used in the table where the index entries are stored.
- The `PowerDemand_Typ` type includes the following:
  - Three attributes (`TotGridDemand`, `MaxCellDemand`, `MinCellDemand`) that are set by three member procedures
  - Power demand readings (100 cells in a grid)
  - The date/time of the power demand readings. (Every hour, 100 areas transmit their power demand readings.)

#### Example 15-2 Creating the Types of Power Demand Cartridge

```
CREATE OR REPLACE TYPE PowerGrid_Typ as VARRAY(100) of NUMBER;

CREATE OR REPLACE TYPE NumTab_Typ as TABLE of NUMBER;
```

```

CREATE OR REPLACE TYPE PowerDemand_Typ AS OBJECT (
  -- Total power demand for the grid
  TotGridDemand NUMBER,
  -- Cell with maximum/minimum power demand for the grid
  MaxCellDemand NUMBER,
  MinCellDemand NUMBER,
  -- Power grid: 10X10 array represented as Varray(100)
  -- using previously defined PowerGrid_Typ
  CellDemandValues PowerGrid_Typ,
  -- Date/time for power-demand samplings: Every hour,
  -- 100 areas transmit their power demand readings.
  SampleTime DATE,
  --
  -- Methods (Set...) for this type:
  -- Total demand for the entire power grid for a
  -- SampleTime: sets the value of TotGridDemand.
  Member Procedure SetTotalDemand,
  -- Maximum demand for the entire power grid for a
  -- SampleTime: sets the value of MaxCellDemand.
  Member Procedure SetMaxDemand,
  -- Minimum demand for the entire power grid for a
  -- SampleTime: sets the value of MinCellDemand.
  Member Procedure SetMinDemand
);
/

```

### 15.4.3 Defining the Object Type Methods

The `PowerDemand_Typ` object type has methods that set the first three attributes in the type definition:

- `TotGridDemand`, the total demand for the entire power grid for the hour in question (identified by `SampleTime`)
- `MaxCellDemand`, the highest power demand value for all cells for the `SampleTime`
- `MinCellDemand`, the lowest power demand value for all cells for the `SampleTime`

The logic for each procedure is not complicated. `SetTotDemand` loops through the cell values and creates a running total. `SetMaxDemand` compares the first two cell values and saves the higher as the current highest value; it then examines each successive cell, comparing it against the current highest value and saving the higher of the two as the current highest value, until it reaches the end of the cell values. `SetMinDemand` uses the same approach as `SetMaxDemand`, but it continually saves the lower value in comparisons to derive the lowest value overall, as demonstrated in [Example 15-3](#).

#### Example 15-3 Implementing an Object Type for Power Demand Cartridge

```

CREATE OR REPLACE TYPE BODY PowerDemand_Typ
IS
  --
  -- Methods (Set...) for this type:
  -- Total demand for the entire power grid for a
  -- SampleTime: sets the value of TotGridDemand.
  Member Procedure SetTotalDemand
  IS
    I BINARY_INTEGER;
    Total NUMBER;
  BEGIN
    Total :=0;
    I := CellDemandValues.FIRST;

```

```

        WHILE I IS NOT NULL LOOP
        Total := Total + CellDemandValues(I);
            I := CellDemandValues.NEXT(I);
        END LOOP;
        TotGridDemand := Total;
    END;

-- Maximum demand for the entire power grid for a
-- SampleTime: sets the value of MaxCellDemand.
Member Procedure SetMaxDemand
IS
I BINARY_INTEGER;
Temp NUMBER;
BEGIN
    I := CellDemandValues.FIRST;
    Temp := CellDemandValues(I);
    WHILE I IS NOT NULL LOOP
    IF Temp < CellDemandValues(I) THEN
        Temp := CellDemandValues(I);
    END IF;
        I := CellDemandValues.NEXT(I);
    END LOOP;
    MaxCellDemand := Temp;
END;

-- Minimum demand for the entire power grid for a
-- SampleTime: sets the value of MinCellDemand.
Member Procedure SetMinDemand
IS
I BINARY_INTEGER;
Temp NUMBER;
BEGIN
    I := CellDemandValues.FIRST;
    Temp := CellDemandValues(I);
    WHILE I IS NOT NULL LOOP
    IF Temp > CellDemandValues(I) THEN
        Temp := CellDemandValues(I);
    END IF;
        I := CellDemandValues.NEXT(I);
    END LOOP;
    MinCellDemand := Temp;
END;
END;
/

```

## 15.4.4 Understanding Functions and Operators

The power demand cartridge is designed so that users can query the power grid for relationships of equality, greaterthan, or lessthan. However, because of the way the cell demand data is stored, the standard operators (=, >, <) cannot be used. Instead, new operators must be created, and a function must be created to define the implementation for each new operator (that is, how the operator is to be interpreted by Oracle).

For this cartridge, each of the three relationships can be checked in two ways:

- Whether a specific cell in the grid satisfies the relationship. For example, are there grids where cell (3,7) has demand equal to 25?

These operators have names in the form `Power_XXXXXSpecific()`, such as `Power_EqualsSpecific()`, and the implementing functions have names in the form `Power_XXXXXSpecific_Func()`.

- Whether any cell in the grid satisfies the relationship. For example, are there grids where any cell has demand equal to 25?

These operators have names in the form `Power_XXXXXAny()`, such as `Power_EqualsAny()`, and the implementing functions have names in the form `Power_XXXXXAny_Func()`.

For each operator-function pair, the function is defined first and then the operator as using the function. The function is the implementation that would be used if there were no index defined. This implementation must be specified so that the Oracle optimizer can determine costs, decide whether the index should be used, and create an execution plan.

Table 15-3 shows the operators and implementing functions:

**Table 15-3 Operators and Implementing Functions**

Operator	Implementing Function
<code>Power_EqualsSpecific()</code>	<code>Power_EqualsSpecific_Func()</code>
<code>Power_EqualsAny()</code>	<code>Power_EqualsAny_Func()</code>
<code>Power_LessThanSpecific()</code>	<code>Power_LessThanSpecific_Func()</code>
<code>Power_LessThanAny()</code>	<code>Power_LessThanAny_Func()</code>
<code>Power_GreaterThanSpecific()</code>	<code>Power_GreaterThanSpecific_Func()</code>
<code>Power_GreaterThanAny()</code>	<code>Power_GreaterThanAny_Func()</code>

Each function and operator returns a numeric value of 1 if the condition is true (for example, if the specified cell is equal to the specified value), 0 if the condition is not true, or null if the specified cell number is invalid.

The statements in Example 15-4 create the implementing functions, `Power_XXX_Func()`, first the `specific` and then the `any` implementations.

The statements in Example 15-5 create the operators (`Power_XXX`). Each statement specifies an implementing function.

### 15.4.4.1 Creating Functions and Operators

Examples Example 15-4 and Example 15-5 demonstrate how to implement functions and operators for the previously defined object types of the Power Demand cartridge.

#### Example 15-4 Implementing `Power_XXX_Func()` Functions for Power Demand Cartridge

```
CREATE FUNCTION Power_EqualsSpecific_Func(
  object PowerDemand_Typ, cell NUMBER, value NUMBER)
```

```
RETURN NUMBER AS
BEGIN
  IF cell <= object.CellDemandValues.LAST
  THEN
    IF (object.CellDemandValues(cell) = value) THEN
      RETURN 1;
    ELSE
      RETURN 0;
    END IF;
  ELSE
    RETURN NULL;
  END IF;
END;
/
CREATE FUNCTION Power_GreaterThanSpecific_Func(
  object PowerDemand_Typ, cell NUMBER, value NUMBER)
RETURN NUMBER AS
BEGIN
  IF cell <= object.CellDemandValues.LAST
  THEN
    IF (object.CellDemandValues(cell) > value) THEN
      RETURN 1;
    ELSE
      RETURN 0;
    END IF;
  ELSE
    RETURN NULL;
  END IF;
END;
/
CREATE FUNCTION Power_LessThanSpecific_Func(
  object PowerDemand_Typ, cell NUMBER, value NUMBER)
RETURN NUMBER AS
BEGIN
  IF cell <= object.CellDemandValues.LAST
  THEN
    IF (object.CellDemandValues(cell) < value) THEN
      RETURN 1;
    ELSE
      RETURN 0;
    END IF;
  ELSE
    RETURN NULL;
  END IF;
END;
/
CREATE FUNCTION Power_EqualsAny_Func(
  object PowerDemand_Typ, value NUMBER)
RETURN NUMBER AS
  idx NUMBER;
BEGIN
  FOR idx IN object.CellDemandValues.FIRST..object.CellDemandValues.LAST LOOP
    IF (object.CellDemandValues(idx) = value) THEN
      RETURN 1;
    END IF;
  END LOOP;
  RETURN 0;
END;
/
CREATE FUNCTION Power_GreaterThanAny_Func(
  object PowerDemand_Typ, value NUMBER)
```

```

RETURN NUMBER AS
  idx NUMBER;
BEGIN
  FOR idx IN object.CellDemandValues.FIRST..object.CellDemandValues.LAST LOOP
    IF (object.CellDemandValues(idx) > value) THEN
      RETURN 1;
    END IF;
  END LOOP;
  RETURN 0;
END;
/
CREATE FUNCTION Power_LessThanAny_Func(
  object PowerDemand_Typ, value NUMBER)
RETURN NUMBER AS
  idx NUMBER;
BEGIN
  FOR idx IN object.CellDemandValues.FIRST..object.CellDemandValues.LAST LOOP
    IF (object.CellDemandValues(idx) < value) THEN
      RETURN 1;
    END IF;
  END LOOP;
  RETURN 0;
END;
/

```

### Example 15-5 Implementing Power\_XXX() Functions for Power Demand Cartridge

```

CREATE OPERATOR Power_Equals BINDING(PowerDemand_Typ, NUMBER, NUMBER)
  RETURN NUMBER USING Power_EqualsSpecific_Func;
CREATE OPERATOR Power_GreaterThan BINDING(PowerDemand_Typ, NUMBER, NUMBER)
  RETURN NUMBER USING Power_GreaterThanSpecific_Func;
CREATE OPERATOR Power_LessThan BINDING(PowerDemand_Typ, NUMBER, NUMBER)
  RETURN NUMBER USING Power_LessThanSpecific_Func;

CREATE OPERATOR Power_EqualsAny BINDING(PowerDemand_Typ, NUMBER)
  RETURN NUMBER USING Power_EqualsAny_Func;
CREATE OPERATOR Power_GreaterThanAny BINDING(PowerDemand_Typ, NUMBER)
  RETURN NUMBER USING Power_GreaterThanAny_Func;
CREATE OPERATOR Power_LessThanAny BINDING(PowerDemand_Typ, NUMBER)
  RETURN NUMBER USING Power_LessThanAny_Func;

```

## 15.4.5 Creating the Indextype Implementation Methods

The power demand cartridge creates an object type for the indextype that specifies methods for the domain index. These methods are part of the `ODCIIndex` (Oracle Data Cartridge Interface Index) interface, and they collectively define the behavior of the index in terms of the methods for defining, manipulating, scanning, and exporting the index.

[Table 15-4](#) shows the method functions (all but one starting with `ODCIIndex`) created for the power demand cartridge.

**Table 15-4** Indextype Methods

Method	Description
<code>ODCIGetInterfaces()</code>	Returns the list interface names implemented by the type.



**Table 15-4 (Cont.) Indextype Methods**

Method	Description
<a href="#">ODCIIndexCreate()</a>	Creates a table to store index data. If the base table containing data to be indexed is not empty, this method builds the index for existing data.  This method is called when a <code>CREATE INDEX</code> statement is issued that refers to the indextype. Upon invocation, any parameters specified in the <code>PARAMETERS</code> clause are passed in along with a description of the index.
<a href="#">ODCIIndexDrop()</a>	Drops the table that stores the index data. This method is called when a <code>DROP INDEX</code> statement specifies the index.
<a href="#">ODCIIndexStart()</a>	Initializes the scan of the index for the operator predicate. This method is invoked when a query is submitted involving an operator that can be executed using the domain index.
<a href="#">ODCIIndexFetch()</a>	Returns the <code>ROWID</code> of each row that satisfies the operator predicate.
<a href="#">ODCIIndexClose()</a>	Ends the current use of the index. This method can perform any necessary clean-up.
<a href="#">ODCIIndexInsert()</a>	Maintains the index structure when a record is inserted in a table that contains columns or object attributes indexed by the indextype.
<a href="#">ODCIIndexDelete()</a>	Maintains the index structure when a record is deleted from a table that contains columns or object attributes indexed by the indextype.
<a href="#">ODCIIndexUpdate()</a>	Maintains the index structure when a record is updated (modified) in a table that contains columns or object attributes indexed by the indextype.
<a href="#">ODCIIndexGetMetadata()</a>	Allows the export and import of implementation-specific metadata associated with the index.

## 15.4.6 Defining theType

**Example 15-6** creates the `power_idxtype_im` object type. The methods of this type are the ODCI methods to define, manipulate, and scan the domain index. The `curnum` attribute is the cursor number used as context for the scan routines [ODCIIndexStart\(\)](#), [ODCIIndexFetch\(\)](#), and [ODCIIndexClose\(\)](#).

The `CREATE TYPE` statement is followed by a `CREATE TYPE BODY` statement that specifies the implementation for each member function:

```
CREATE OR REPLACE TYPE BODY power_idxtype_im
IS
...
```

All the method definitions (except for [ODCIIndexGetMetadata\(\)](#), which returns a `VARCHAR2` string) have the following general form:

```
STATIC FUNCTION function-name (...)
RETURN NUMBER
IS
...
END;
```

**Example 15-6 Creating power\_idxtype\_im Object Type for Power Demand Cartridge**

```

CREATE OR REPLACE TYPE power_idxtype_im AS OBJECT
(
  curnum NUMBER,
  STATIC FUNCTION ODCIGetInterfaces(ifclist OUT sys.ODCIObjectList)
    RETURN NUMBER,
  STATIC FUNCTION ODCIIndexCreate (ia sys.ODCIIndexInfo, parms VARCHAR2,
    env sys.ODCIEnv) RETURN NUMBER,
  STATIC FUNCTION ODCIIndexDrop(ia sys.ODCIIndexInfo, env sys.ODCIEnv)
    RETURN NUMBER,
  STATIC FUNCTION ODCIIndexStart(sctx IN OUT power_idxtype_im,
    ia sys.ODCIIndexInfo,
    op sys.ODCIPredInfo, qi sys.ODCIQueryInfo,
    strt NUMBER, stop NUMBER,
    cmppos NUMBER, cmpval NUMBER, env sys.ODCIEnv)
    RETURN NUMBER,
  STATIC FUNCTION ODCIIndexStart(sctx IN OUT power_idxtype_im,
    ia sys.ODCIIndexInfo,
    op sys.ODCIPredInfo, qi sys.ODCIQueryInfo,
    strt NUMBER, stop NUMBER,
    cmpval NUMBER, env sys.ODCIEnv)
    RETURN NUMBER,
  MEMBER FUNCTION ODCIIndexFetch(nrows NUMBER, rids OUT sys.ODCIRidList,
    env sys.ODCIEnv) RETURN NUMBER,
  MEMBER FUNCTION ODCIIndexClose (env sys.ODCIEnv) RETURN NUMBER,
  STATIC FUNCTION ODCIIndexInsert(ia sys.ODCIIndexInfo, rid VARCHAR2,
    newval PowerDemand_Typ, env sys.ODCIEnv)
    RETURN NUMBER,
  STATIC FUNCTION ODCIIndexDelete(ia sys.ODCIIndexInfo, rid VARCHAR2,
    oldval PowerDemand_Typ, env sys.ODCIEnv)
    RETURN NUMBER,
  STATIC FUNCTION ODCIIndexUpdate(ia sys.ODCIIndexInfo, rid VARCHAR2,
    oldval PowerDemand_Typ,
    newval PowerDemand_Typ, env sys.ODCIEnv)
    RETURN NUMBER,
  STATIC FUNCTION ODCIIndexGetMetadata(ia sys.ODCIIndexInfo,
    expversion VARCHAR2,
    newblock OUT PLS_INTEGER,
    env sys.ODCIEnv)
    RETURN VARCHAR2
);
/

```

**15.4.6.1 ODCIGetInterfaces()**

The [ODCIGetInterfaces\(\)](#) function returns the list of names of the interfaces implemented by the type. To specify the current version of these interfaces, the [ODCIGetInterfaces\(\)](#) routine must return 'SYS.ODCIINDEX2' in the OUT parameter, as demonstrated in [Example 15-7](#).

**Example 15-7 Registering Interface and Index Functions in Power Demand Cartridge**

```

STATIC FUNCTION ODCIGetInterfaces(
  ifclist OUT sys.ODCIObjectList)
RETURN NUMBER IS
BEGIN
  ifclist := sys.ODCIObjectList(sys.ODCIObject('SYS', 'ODCIINDEX2'));

```

```

    return ODCIConst.Success;
END ODCIGetInterfaces;

```

## 15.4.6.2 ODCIIndexCreate()

The [ODCIIndexCreate\(\)](#) function creates the table to store index data. If the base table containing data to be indexed is not empty, this method inserts the index data entries for existing data.

The function takes the index information as an object parameter whose type is `SYS.ODCIINDEXINFO`. The type attributes include the index name, owner name, and so forth. The `PARAMETERS` string specified in the `CREATE INDEX` statement is also passed in as a parameter to the function, as demonstrated in [Example 15-8](#).

### Example 15-8 Registering ODCIIndexCreate() for Power Demand Cartridge

```

STATIC FUNCTION ODCIIndexCreate (
    ia sys.ODCIIndexInfo,
    parms VARCHAR2,
    env sys.ODCIEnv)
RETURN NUMBER IS
    i INTEGER;
    r ROWID;
    p NUMBER;
    v NUMBER;
    stmt1 VARCHAR2(1000);
    stmt2 VARCHAR2(1000);
    stmt3 VARCHAR2(1000);
    cnum1 INTEGER;
    cnum2 INTEGER;
    cnum3 INTEGER;
    junk NUMBER;

```

The SQL statement to create the table for the index data is constructed and executed. The table includes the `ROWID` of the base table, `r`, the cell position number (`cpos`) in the grid from 1 to 100, and the power demand value in that cell (`cval`).

```

BEGIN
    -- Construct the SQL statement.
    stmt1 := 'CREATE TABLE ' || ia.IndexSchema || '.' || ia.IndexName || '_pidx' ||
        '( r ROWID, cpos NUMBER, cval NUMBER)';

    -- Dump the SQL statement.
    dbms_output.put_line('ODCIIndexCreate>>>>');
    sys.ODCIIndexInfoDump(ia);
    dbms_output.put_line('ODCIIndexCreate>>>>' || stmt1);

    -- Execute the statement.
    cnum1 := dbms_sql.open_cursor;
    dbms_sql.parse(cnum1, stmt1, dbms_sql.native);
    junk := dbms_sql.execute(cnum1);
    dbms_sql.close_cursor(cnum1);

```

The function populates the index by inserting rows into the table. The function "unnests" the `VARRAY` attribute and inserts a row for each cell into the table. Thus, each 10 X 10 grid (10 rows, 10 values for each row) becomes 100 rows in the table (one row for each cell).

```

    -- Now populate the table.
    stmt2 := ' INSERT INTO ' || ia.IndexSchema || '.' || ia.IndexName || '_pidx' ||

```

```

' SELECT :rr, ROWNUM, column_value FROM THE' || ' (SELECT CAST (P.' ||
ia.IndexCols(1).ColName || '.CellDemandValues AS NumTab_Typ)' || ' FROM ' ||
ia.IndexCols(1).TableSchema || '.' || ia.IndexCols(1).TableName || ' P' ||
' WHERE P.ROWID = :rr)';

-- Execute the statement.
dbms_output.put_line('ODCIIndexCreate>>>>' || stmt2);

-- Parse the statement.
cnum2 := dbms_sql.open_cursor;
dbms_sql.parse(cnum2, stmt2, dbms_sql.native);

stmt3 := 'SELECT ROWID FROM ' || ia.IndexCols(1).TableSchema || '.' ||
ia.IndexCols(1).TableName;
dbms_output.put_line('ODCIIndexCreate>>>>' || stmt3);
cnum3 := dbms_sql.open_cursor;
dbms_sql.parse(cnum3, stmt3, dbms_sql.native);
dbms_sql.define_column_rowid(cnum3, 1, r);
junk := dbms_sql.execute(cnum3);

WHILE dbms_sql.fetch_rows(cnum3) > 0 LOOP
-- Get column values of the row. --
dbms_sql.column_value_rowid(cnum3, 1, r);
-- Bind the row into the cursor for the next insert. --
dbms_sql.bind_variable_rowid(cnum2, ':rr', r);
junk := dbms_sql.execute(cnum2);
END LOOP;

```

The function concludes by closing the cursors and returning a success status.

```

dbms_sql.close_cursor(cnum2);
dbms_sql.close_cursor(cnum3);
RETURN ODCICONST.SUCCESS;
END ODCIIndexCreate;

```

### 15.4.6.3 ODCIIndexDrop()

The [ODCIIndexDrop\(\)](#) function drops the table that stores the index data, as demonstrated in [Example 15-9](#). This method is called when a `DROP INDEX` statement is issued.

#### Example 15-9 Registering ODCIIndexDrop() for Power Demand Cartridge

```

STATIC FUNCTION ODCIIndexDrop(ia sys.ODCIIndexInfo, env sys.ODCIEnv)
RETURN NUMBER IS
  stmt VARCHAR2(1000);
  cnum INTEGER;
  junk INTEGER;
BEGIN
  -- Construct the SQL statement.
  stmt := 'drop table ' || ia.IndexSchema || '.' || ia.IndexName || '_pidx';

  dbms_output.put_line('ODCIIndexDrop>>>>');
  sys.ODCIIndexInfoDump(ia);
  dbms_output.put_line('ODCIIndexDrop>>>>' || stmt);

  -- Execute the statement.
  cnum := dbms_sql.open_cursor;
  dbms_sql.parse(cnum, stmt, dbms_sql.native);
  junk := dbms_sql.execute(cnum);
  dbms_sql.close_cursor(cnum);

```

```

RETURN ODCICONST.SUCCESS;
END ODCIIndexDrop;

```

### 15.4.6.4 ODCIIndexStart(); Specific Queries

The first definition of the `ODCIIndexStart()` function initializes the scan of the index to return all rows that satisfy the operator predicate. For example, if a query asks for all instances where cell (3,7) has a value equal to 25, the function initializes the scan to return all rows in the index-organized table for which that cell has that value. This definition of `ODCIIndexStart()` differs from the definition in `ODCIIndexStart(); Any Queries` in that it includes the `cmppos` parameter for the position of the cell.

The `self` parameter is the context that is shared with the `ODCIIndexFetch()` and `ODCIIndexClose()` functions. The `ia` parameter contains the index information as an object instance of type `SYS.ODCIINDEXINFO`, and the `op` parameter contains the operator information as an object instance of type `SYS.ODCIOPERINFO`. The `strt` and `stop` parameters are the lower and upper boundary points for the operator return value. The `cmppos` parameter is the cell position and `cmpval` is the value in the cell specified by the operator `Power_XxxxxSpecific()`. This is demonstrated in [Example 15-10](#).

#### Example 15-10 Registering ODCIIndexStart() for Power Demand Cartridge

```

STATIC FUNCTION ODCIIndexStart(
    sctx IN OUT power_idxtype_im,
    ia sys.ODCIIndexInfo,
    op sys.ODCIPredInfo,
    qi sys.ODCIQueryInfo,
    strt NUMBER, stop NUMBER,
    cmppos NUMBER,
    cmpval NUMBER,
    env sys.ODCIEnv )
RETURN NUMBER IS
    cnum INTEGER;
    rid ROWID;
    nrows INTEGER;
    relop VARCHAR2(2);
    stmt VARCHAR2(1000);
BEGIN
    dbms_output.put_line('ODCIIndexStart>>>>');
    sys.ODCIIndexInfoDump(ia);
    sys.ODCIPredInfoDump(op);
    dbms_output.put_line('start key : '||strt);
    dbms_output.put_line('stop key : '||stop);
    dbms_output.put_line('compare position : '||cmppos);
    dbms_output.put_line('compare value : '||cmpval);

```

The function checks for errors in the predicate.

```

-- Take care of some error cases.
-- The only predicates in which btree operators can appear are
--   op() = 1      OR   op() = 0
if (strt != 1) and (strt != 0) then
    raise_application_error(-20101, 'Incorrect predicate for operator');
END if;

if (stop != 1) and (stop != 0) then
    raise_application_error(-20101, 'Incorrect predicate for operator');
END if;

```

The function generates the SQL statement to be executed. It determines the operator name and the lower and upper index value bounds (the start and stop keys). The start and stop keys can both be 1 (= TRUE) or both be 0 (= FALSE).

```
-- Generate the SQL statement to be executed.
-- First, figure out the relational operator needed for the statement.
-- Take into account the operator name and the start and stop keys. For now,
-- the start and stop keys can both be 1 (= TRUE) or both be 0 (= FALSE).
if op.ObjectName = 'POWER_EQUALS' then
  if strt = 1 then
    relop := '=';
  else
    relop := '!=';
  end if;
elsif op.ObjectName = 'POWER_LESSTHAN' then
  if strt = 1 then
    relop := '<';
  else
    relop := '>=';
  end if;
elsif op.ObjectName = 'POWER_GREATERTHAN' then
  if strt = 1 then
    relop := '>';
  else
    relop := '<=';
  end if;
else
  raise_application_error(-20101, 'Unsupported operator');
end if;

stmt := 'select r from '||ia.IndexSchema||'.'||ia.IndexName||'_pidx'||
' where cpos '|| '=' ||'||cmppos||' and cval '||relop||'
      cmpval';

dbms_output.put_line('ODCIIndexStart>>>>' || stmt);
cnum := dbms_sql.open_cursor;
dbms_sql.parse(cnum, stmt, dbms_sql.native);
dbms_sql.define_column_rowid(cnum, 1, rid);
nrows := dbms_sql.execute(cnum);
```

The function stores the cursor number in the context, which is used by the `ODCIIndexFetch` function, and sets a success return status.

```
-- Set context as the cursor number.
stcx := power_idxtype_im(cnum);

-- Return success.
RETURN ODCICONST.SUCCESS;
END ODCIIndexStart;
```

#### See Also:

- [ODCIIndexClose\(\)](#)
- [ODCIIndexFetch\(\)](#)
- [ODCIIndexStart\(\)](#)
- [ODCIIndexStart\(\); Any Queries](#)

### 15.4.6.5 ODCIIndexStart(); Any Queries

This definition of the `ODCIIndexStart()` function initializes the scan of the index to return all rows that satisfy the operator predicate. For example, if a query asks for all instances where any cell has a value equal to 25, the function initializes the scan to return all rows in the index-organized table for which that cell has that value. This definition of differs from the definition in `ODCIIndexStart(); Specific Queries` in that it does not include the `cmppos` parameter.

The `self` parameter is the context that is shared with the `ODCIIndexFetch()` and `ODCIIndexClose()` functions. The `ia` parameter contains the index information as an object instance of type `SYS.ODCIINDEXINFO`, and the `op` parameter contains the operator information as an object instance of type `SYS.ODCIOPERINFO`. The `strt` and `stop` parameters are the lower and upper boundary points for the operator return value. The `cmpval` parameter is the value in the cell specified by the operator `Power_Xxxx()`.

#### Example 15-11 Registering ODCIIndexStart() for Any Queries for Power Demand Cartridge

```

STATIC FUNCTION ODCIIndexStart(
    sctx IN OUT power_idxtype_im,
    ia sys.ODCIIndexInfo,
    op sys.ODCIPredInfo,
    qi sys.ODCIQueryInfo,
    strt NUMBER,
    stop NUMBER,
    cmpval NUMBER,
    env sys.ODCIEnv )
RETURN NUMBER IS
    cnum INTEGER;
    rid ROWID;
    nrows INTEGER;
    relop VARCHAR2(2);
    stmt VARCHAR2(1000);
BEGIN
    dbms_output.put_line('ODCIIndexStart>>>>');
    sys.ODCIIndexInfoDump(ia);
    sys.ODCIPredInfoDump(op);
    dbms_output.put_line('start key : '||strt);
    dbms_output.put_line('stop key : '||stop);
    dbms_output.put_line('compare value : '||cmpval);

```

The function checks for errors in the predicate.

```

-- Take care of some error cases.
-- The only predicates in which btree operators can appear are
--   op() = 1   OR   op() = 0
if (strt != 1) and (strt != 0) then
    raise_application_error(-20101, 'Incorrect predicate for operator');
END if;

if (stop != 1) and (stop != 0) then
    raise_application_error(-20101, 'Incorrect predicate for operator');
END if;

```

The function generates the SQL statement to be executed. It determines the operator name and the lower and upper index value bounds (the start and stop keys). The start and stop keys can both be 1 (= TRUE) or both be 0 (= FALSE).

```

-- Generate the SQL statement to be executed.
-- First, figure out the relational operator needed for the statement.
-- Take into account the operator name and the start and stop keys. For now,
-- the start and stop keys can both be 1 (= TRUE) or both be 0 (= FALSE).
if op.ObjectName = 'POWER_EQUALSANY' then
    relop := '=';
elsif op.ObjectName = 'POWER_LESSTHANANY' then
    relop := '<';
elsif op.ObjectName = 'POWER_GREATERTHANANY' then
    relop := '>';
else
    raise_application_error(-20101, 'Unsupported operator');
end if;

-- This statement returns the qualifying rows for the TRUE case.
stmt := 'select distinct r from '||ia.IndexSchema||'.'||ia.IndexName||'_pidx' ||
        'where cval '||relop||''''||cmpval||'''';
-- In the FALSE case, we must find the complement of the rows.
if (strt = 0) then
    stmt := 'select distinct r from '||ia.IndexSchema||'.'||ia.IndexName||
        '_pidx' ||' minus '||stmt;
end if;

dbms_output.put_line('ODCIIndexStart>>>>' || stmt);
cnum := dbms_sql.open_cursor;
dbms_sql.parse(cnum, stmt, dbms_sql.native);
dbms_sql.define_column_rowid(cnum, 1, rid);
nrows := dbms_sql.execute(cnum);

```

The function stores the cursor number in the context, which is used by the `ODCIIndexFetch()` function, and sets a success return status.

```

-- Set context as the cursor number.
self := power_idxtype_im(cnum);

-- Return success.
RETURN ODCICONST.SUCCESS;
END ODCIIndexStart;

```

#### See Also:

- [ODCIIndexClose\(\)](#)
- [ODCIIndexFetch\(\)](#)
- [ODCIIndexStart\(\)](#)
- [ODCIIndexStart\(\); Specific Queries](#)

### 15.4.6.6 ODCIIndexFetch()

The `ODCIIndexFetch()` function, demonstrated in [Example 15-12](#) returns a batch of `ROWIDs` for the rows that satisfy the operator predicate. Each time `ODCIIndexFetch()` is invoked, it returns the next batch of rows (`rids` parameter, a collection of type `SYS.ODCIRIDLIST`) that satisfy the operator predicate. The maximum number of rows that can be returned on each invocation is specified by the `nrows` parameter.



Oracle invokes `ODCIIndexFetch()` repeatedly until all rows that satisfy the operator predicate have been returned.

### Example 15-12 Registering `ODCIIndexFetch()` for Power Demand Cartridge

```
MEMBER FUNCTION ODCIIndexFetch(
  nrows NUMBER,
  rids OUT sys.ODCIRidList,
  env sys.ODCIEnv)
RETURN NUMBER IS
  cnum INTEGER;
  idx INTEGER := 1;
  rlist sys.ODCIRidList := sys.ODCIRidList();
  done boolean := FALSE;
```

The function loops through the collection of rows selected by the `ODCIIndexStart()` function, using the same cursor number, `cnum`, as in the `ODCIIndexStart()` function, and returns the `ROWIDs`.

```
BEGIN
  dbms_output.put_line('ODCIIndexFetch>>>>');
  dbms_output.put_line('Nrows : '||round(nrows));

  cnum := self.curnum;

  WHILE not done LOOP
    if idx > nrows then
      done := TRUE;
    else
      rlist.extend;
      if dbms_sql.fetch_rows(cnum) > 0 then
        dbms_sql.column_value_rowid(cnum, 1, rlist(idx));
        idx := idx + 1;
      else
        rlist(idx) := null;
        done := TRUE;
      END if;
    END if;
  END LOOP;

  rids := rlist;
  RETURN ODCICONST.SUCCESS;
END ODCIIndexFetch;
```



#### See Also:

- [ODCIIndexFetch\(\)](#)
- [ODCIIndexStart\(\)](#)

### 15.4.6.7 `ODCIIndexClose()`

The `ODCIIndexClose()` function, demonstrated in [Example 15-13](#), closes the cursor used by the `ODCIIndexStart()` and `ODCIIndexFetch()` functions.

**Example 15-13 Registering ODCIIndexStart() for Power Demand Cartridge**

```

MEMBER FUNCTION ODCIIndexClose (env sys.ODCIEnv)
RETURN NUMBER IS
    cnum INTEGER;
BEGIN
    dbms_output.put_line('ODCIIndexClose>>>>');

    cnum := self.curnum;
    dbms_sql.close_cursor(cnum);
    RETURN ODCICONST.SUCCESS;
END ODCIIndexClose;

```

**15.4.6.8 ODCIIndexInsert()**

The [ODCIIndexInsert\(\)](#) function, demonstrated in [Example 15-14](#), is called when a record is inserted in a table that contains columns or `OBJECT` attributes indexed by the indextype. The new values in the indexed columns are passed in as arguments along with the corresponding row identifier.

**Example 15-14 Registering ODCIIndexInsert() for Power Demand Cartridge**

```

STATIC FUNCTION ODCIIndexInsert(
    ia sys.ODCIIndexInfo,
    rid VARCHAR2,
    newval PowerDemand_Typ,
    env sys.ODCIEnv)
RETURN NUMBER AS
    cid INTEGER;
    i BINARY_INTEGER;
    nrows INTEGER;
    stmt VARCHAR2(1000);
BEGIN
    dbms_output.put_line(' ');
    dbms_output.put_line('ODCIIndexInsert>>>>' || ' TotGridDemand= ' ||
        newval.TotGridDemand || ' MaxCellDemand= ' || newval.MaxCellDemand ||
        ' MinCellDemand= ' || newval.MinCellDemand);
    sys.ODCIIndexInfoDump(ia);

    -- Construct the statement.
    stmt := ' INSERT INTO ' || ia.IndexSchema || '.' || ia.IndexName || '_pid' ||
        ' VALUES (:rr, :pos, :val)';

    -- Execute the statement.
    dbms_output.put_line('ODCIIndexInsert>>>>' || stmt);
    -- Parse the statement.
    cid := dbms_sql.open_cursor;
    dbms_sql.parse(cid, stmt, dbms_sql.native);
    dbms_sql.bind_variable_rowid(cid, ':rr', rid);

    -- Iterate over the rows of the Varray and insert them.
    i := newval.CellDemandValues.FIRST;
    WHILE i IS NOT NULL LOOP
        -- Bind the row into the cursor for insert.
        dbms_sql.bind_variable(cid, ':pos', i);
        dbms_sql.bind_variable(cid, ':val', newval.CellDemandValues(i));
        -- Execute.
        nrows := dbms_sql.execute(cid);
        dbms_output.put_line('ODCIIndexInsert>>>>' || 'RID' || ' , ' || i || ' , ' ||
            newval.CellDemandValues(i) || ' ');
        i := newval.CellDemandValues.NEXT(i);
    END LOOP;
END ODCIIndexInsert;

```

```

END LOOP;

dbms_sql.close_cursor(cid);
RETURN ODCICONST.SUCCESS;
END ODCIIndexInsert;

```

### 15.4.6.9 ODCIIndexDelete()

The `ODCIIndexDelete()` function, demonstrated in [Example 15-15](#), is called when a record is deleted from a table that contains columns or object attributes indexed by the `indextype`. The old values in the indexed columns are passed in as arguments along with the corresponding row identifier.

#### Example 15-15 Registering `ODCIIndexDelete()` for Power Demand Cartridge

```

STATIC FUNCTION ODCIIndexDelete(
    ia sys.ODCIIndexInfo,
    rid VARCHAR2,
    oldval PowerDemand_Typ,
    env sys.ODCIEnv)
RETURN NUMBER AS
    cid INTEGER;
    stmt VARCHAR2(1000);
    nrows INTEGER;
BEGIN
    dbms_output.put_line(' ');
    dbms_output.put_line('ODCIIndexDelete>>>>' || ' TotGridDemand= ' ||
        oldval.TotGridDemand || ' MaxCellDemand= ' || oldval.MaxCellDemand ||
        ' MinCellDemand= ' || oldval.MinCellDemand) ;
    sys.ODCIIndexInfoDump(ia);

    -- Construct the statement.
    stmt := ' DELETE FROM ' || ia.IndexSchema || '.' || ia.IndexName || '_pidx' ||
        ' WHERE r=:rr';
    dbms_output.put_line('ODCIIndexDelete>>>>' || stmt);

    -- Parse and execute the statement.
    cid := dbms_sql.open_cursor;
    dbms_sql.parse(cid, stmt, dbms_sql.native);
    dbms_sql.bind_variable_rowid(cid, ':rr', rid);
    nrows := dbms_sql.execute(cid);
    dbms_sql.close_cursor(cid);

    RETURN ODCICONST.SUCCESS;
END ODCIIndexDelete;

```

### 15.4.6.10 ODCIIndexUpdate()

The `ODCIIndexUpdate()` function, demonstrated in [Example 15-16](#), is called when a record is updated in a table that contains columns or object attributes indexed by the `indextype`. The old and new values in the indexed columns are passed in as arguments along with the row identifier.

#### Example 15-16 Registering `ODCIIndexUpdate()` for Power Demand Cartridge

```

STATIC FUNCTION ODCIIndexUpdate(
    ia sys.ODCIIndexInfo,
    rid VARCHAR2,
    oldval PowerDemand_Typ,
    newval PowerDemand_Typ,

```

```

env sys.ODCIEnv)
RETURN NUMBER AS
  cid INTEGER;
  cid2 INTEGER;
  stmt VARCHAR2(1000);
  stmt2 VARCHAR2(1000);
  nrows INTEGER;
  i NUMBER;
BEGIN
  dbms_output.put_line(' ');
  dbms_output.put_line('ODCIIndexUpdate>>>> Old'||' TotGridDemand= '||
    oldval.TotGridDemand||' MaxCellDemand= '||oldval.MaxCellDemand ||
    ' MinCellDemand= '||oldval.MinCellDemand) ;
  dbms_output.put_line('ODCIIndexUpdate>>>> New'||' TotGridDemand= '||
    newval.TotGridDemand ||' MaxCellDemand= '||newval.MaxCellDemand ||
    ' MinCellDemand= '||newval.MinCellDemand) ;
  sys.ODCIIndexInfoDump(ia);

  -- Delete old entries.
  stmt := ' DELETE FROM '||ia.IndexSchema ||'.'||ia.IndexName||'_pidx' ||
    ' WHERE r=:rr';
  dbms_output.put_line('ODCIIndexUpdate>>>>'||stmt);

  -- Parse and execute the statement.
  cid := dbms_sql.open_cursor;
  dbms_sql.parse(cid, stmt, dbms_sql.native);
  dbms_sql.bind_variable_rowid(cid, ':rr', rid);
  nrows := dbms_sql.execute(cid);
  dbms_sql.close_cursor(cid);

  -- Insert new entries.
  stmt2 := ' INSERT INTO '||ia.IndexSchema||'.'||ia.IndexName||'_pidx' ||
    ' VALUES (:rr, :pos, :val)';
  dbms_output.put_line('ODCIIndexUpdate>>>>'||stmt2);

  -- Parse and execute the statement.
  cid2 := dbms_sql.open_cursor;
  dbms_sql.parse(cid2, stmt2, dbms_sql.native);
  dbms_sql.bind_variable_rowid(cid2, ':rr', rid);

  -- Iterate over the rows of the Varray and insert them.
  i := newval.CellDemandValues.FIRST;
  WHILE i IS NOT NULL LOOP
    -- Bind the row into the cursor for insert.
    dbms_sql.bind_variable(cid2, ':pos', i);
    dbms_sql.bind_variable(cid2, ':val', newval.CellDemandValues(i));
    nrows := dbms_sql.execute(cid2);
    dbms_output.put_line('ODCIIndexUpdate>>>>('||'RID' ||' , '||i ||' , '||
      newval.CellDemandValues(i)|| ' ');
    i := newval.CellDemandValues.NEXT(i);
  END LOOP;
  dbms_sql.close_cursor(cid2);

  RETURN ODCICONST.SUCCESS;
END ODCIIndexUpdate;

ODCIIndexUpdate is the last method defined in the CREATE TYPE BODY statement, which
ends as follows:

END;
/

```

### 15.4.6.11 ODCIIndexGetMetadata()

The optional `ODCIIndexGetMetadata()` function, as demonstrated in [Example 15-17](#), if present, is called by the Export utility to write implementation-specific metadata (which is not stored in the system catalogs) into the export dump file. This metadata might be policy information, version information, user settings, and so on. This metadata is written to the dump file as anonymous PL/SQL blocks that are executed at import time, immediately before the associated index is created.

This method returns strings to the Export utility that comprise the code of the PL/SQL blocks. The Export utility repeatedly calls this method until a zero-length string is returned, thus allowing the creation of any number of PL/SQL blocks of arbitrary complexity. Normally, this method calls functions within a PL/SQL package to make use of package-level variables, such as cursors and iteration counters, that maintain state across multiple calls by Export.

In the power demand cartridge, the only metadata that is passed is a version string of `v1.0`, identifying the current format of the index-organized table that underlies the domain index. The `power_pkg.getversion` function generates a call to the `power_pkg.checkversion` procedure, to be executed at import time to check that the version string is `v1.0`.

#### Example 15-17 Registering ODCIIndexGetMetadata() for Power Demand Cartridge

```
STATIC FUNCTION ODCIIndexGetMetadata(  
  ia sys.ODCIIndexInfo,  
  expversion VARCHAR2,  
  newblock OUT PLS_INTEGER,  
  env sys.ODCIEnv)  
RETURN VARCHAR2 IS  
  
BEGIN  
  -- Let getversion do all the work since it has to maintain state across calls.  
  
  RETURN power_pkg.getversion (ia.IndexSchema, ia.IndexName, newblock);  
  
  EXCEPTION  
    WHEN OTHERS THEN  
      RAISE;  
  
END ODCIIndexGetMetaData;
```

The `power_pkg` package is defined as follows:

#### Example 15-18 Creating Package `power_pkg` for the Power Demand Cartridge

```
CREATE OR REPLACE PACKAGE power_pkg AS  
  FUNCTION getversion(  
    idxschema IN VARCHAR2,  
    idxname IN VARCHAR2,  
    newblock OUT PLS_INTEGER)  
  RETURN VARCHAR2;  
  
  PROCEDURE checkversion (  
    version IN VARCHAR2);  
END power_pkg;  
/
```

```
SHOW ERRORS;

CREATE OR REPLACE PACKAGE BODY power_pkg AS
  -- iterate is a package-level variable used to maintain state across calls
  -- by Export in this session.

  iterate NUMBER := 0;

  FUNCTION getversion(
    idxschema IN VARCHAR2,
    idxname IN VARCHAR2,
    newblock OUT PLS_INTEGER)
  RETURN VARCHAR2 IS

  BEGIN

  -- We are generating only one PL/SQL block consisting of one line of code.
  newblock := 1;

  IF iterate = 0 THEN
    -- Increment iterate so we'll know we're done next time we're called.
    iterate := iterate + 1;

    -- Return a string that calls checkversion with a version 'V1.0'
    -- Note that export adds the surrounding BEGIN/END pair to form the anon.
    -- block... we don't have to.

    RETURN 'power_pkg.checkversion(''V1.0'')';
  ELSE
    -- reset iterate for next index
    iterate := 0;
    -- Return a 0-length string; we won't be called again for this index.
    RETURN '';
  END IF;
END getversion;

PROCEDURE checkversion (version IN VARCHAR2)
IS
  wrong_version EXCEPTION;

BEGIN
  IF version != 'V1.0' THEN
    RAISE wrong_version;
  END IF;
END checkversion;

END power_pkg;
```

 **See Also:**

*Oracle Database Utilities* for information about the Export and Import utilities

## 15.4.7 Creating the Indextype

The power demand cartridge creates the indextype for the domain index. The specification, in [Example 15-19](#), includes the list of operators supported by the

indextype. It also identifies the implementation type containing the OCI index routines.

### Example 15-19 Creating Indextype power\_idxtype for Power Demand Cartridge

```
CREATE OR REPLACE INDEXTYPE power_idxtype
FOR
  Power_Equals(PowerDemand_Typ, NUMBER, NUMBER),
  Power_GreaterThan(PowerDemand_Typ, NUMBER, NUMBER),
  Power_LessThan(PowerDemand_Typ, NUMBER, NUMBER),
  Power_EqualsAny(PowerDemand_Typ, NUMBER),
  Power_GreaterThanAny(PowerDemand_Typ, NUMBER),
  Power_LessThanAny(PowerDemand_Typ, NUMBER)
USING power_idxtype_im;
```

## 15.5 Defining Types and Methods for Extensible Optimizing

Consider the parts of the power demand cartridge as they relate to extensible optimization.

### 15.5.1 Creating the Statistics Table, PowerCartUserStats

The table `PowerCartUserStats`, demonstrated in [Example 15-20](#), stores statistics about the hourly power grid readings. The method `ODCIStatsSelectivity()` uses these statistics to estimate the selectivity of operator predicates. Because of the types of statistics collected, it is more convenient to use a separate table instead of letting Oracle store the statistics.

The `PowerCartUserStats` table contains the following columns:

- The table and column for which statistics are collected
- The cell for which the statistics are collected
- The minimum and maximum power demand for the given cell over all power grid readings
- The number of non-null readings for the given cell over all power grid reading

### Example 15-20 Creating Statistics Table PowerCartUserStats for Power Demand Cartridge

```
CREATE TABLE PowerCartUserStats (
  -- Table for which statistics are collected
  tab VARCHAR2(30),
  -- Column for which statistics are collected
  col VARCHAR2(30),
  -- Cell position
  cpos NUMBER,
  -- Minimum power demand for the given cell
  lo NUMBER,
  -- Maximum power demand for the given cell
  hi NUMBER,
  -- Number of (non-null) power demands for the given cell
  nrows NUMBER
);
/
```

## 15.5.2 Creating the Extensible Optimizer Methods

The power demand cartridge creates an object type that specifies methods used by the extensible optimizer. These methods are part of the `ODCIStats` interface and they collectively define the methods that are called by the methods of `DBMS_STATS` package, or when the optimizer is deciding on the best execution plan for a query.

Table 15-5 shows the method functions created for the power demand cartridge. Names of all but one of the functions begin with the string `ODCIStats`.

**Table 15-5 Extensible Optimizer Methods**

Method	Description
<code>ODCIGetInterfaces()</code>	Returns the list of names of the interfaces implemented by the type.
<code>ODCIStatsCollect()</code>	Collects statistics for columns of type <code>PowerDemand_Typ</code> or domain indexes of indextype <code>power_idxtype</code> . This method is called when a statement that refers either to a column of the <code>PowerDemand_Typ</code> type or to an index of the <code>power_idxtype</code> indextype is issued. Upon invocation, any specified options are passed in along with a description of the column or index.
<code>ODCIStatsDelete()</code>	Deletes statistics for columns of type <code>PowerDemand_Typ</code> or domain indexes of indextype <code>power_idxtype</code> . This method is called when a statement to delete statistics for a column of the appropriate type or an index of the appropriate indextype is issued.
<code>ODCIStatsSelectivity()</code>	Computes the selectivity of a predicate involving an operator or its functional implementation. Called by the optimizer when a predicate of the appropriate type appears in the <code>WHERE</code> clause of a query.
<code>ODCIStatsIndexCost()</code>	Computes the cost of a domain index access path. Called by the optimizer to get the cost of a domain index access path, assuming the index can be used for the query.
<code>ODCIStatsFunctionCost()</code>	Computes the cost of a function. Called by the optimizer to get the cost of executing a function. The function need not necessarily be an implementation of an operator.

### 15.5.2.1 Creating the Type Definition

Example 15-21 creates the `power_statistics` object type. This object type's ODCI methods are used to collect and delete statistics about columns and indexes, compute selectivities of predicates with operators or functions, and to compute costs of domain indexes and functions. The `curnum` attribute is not used.

The `CREATE TYPE` statement is followed by a `CREATE TYPE BODY` statement that specifies the implementation for each member function:

```
CREATE OR REPLACE TYPE BODY power_statistics
IS
...
```



All the function definitions have the following general form:

```

STATIC FUNCTION function-name (...)
  BEGIN
    RETURN NUMBER IS
  END;

```

### Example 15-21 Creating power\_statistics Object Type Definition for Power Demand Cartridge

```

CREATE OR REPLACE TYPE power_statistics AS OBJECT
(
  curnum NUMBER,
  STATIC FUNCTION ODCIGetInterfaces(ifclist OUT sys.ODCIObjectList)
    RETURN NUMBER,
  STATIC FUNCTION ODCIStatsCollect(col sys.ODCIColInfo,
    options sys.ODCIStatsOptions, rawstats OUT RAW, env sys.ODCIEnv)
    RETURN NUMBER,
  STATIC FUNCTION ODCIStatsDelete(col sys.ODCIColInfo, env sys.ODCIEnv)
    RETURN NUMBER,
  STATIC FUNCTION ODCIStatsCollect(ia sys.ODCIIndexInfo,
    options sys.ODCIStatsOptions, rawstats OUT RAW, env sys.ODCIEnv)
    RETURN NUMBER,
  STATIC FUNCTION ODCIStatsDelete(ia sys.ODCIIndexInfo, env sys.ODCIEnv)
    RETURN NUMBER,
  STATIC FUNCTION ODCIStatsSelectivity(pred sys.ODCIPredInfo,
    sel OUT NUMBER, args sys.ODCIArgDescList, strt NUMBER, stop NUMBER,
    object PowerDemand_Typ, cell NUMBER, value NUMBER, env sys.ODCIEnv)
    RETURN NUMBER,
  STATIC FUNCTION ODCIStatsSelectivity(pred sys.ODCIPredInfo, sel OUT NUMBER,
    args sys.ODCIArgDescList, strt NUMBER, stop NUMBER, object PowerDemand_Typ,
    value NUMBER, env sys.ODCIEnv)
    RETURN NUMBER,
  STATIC FUNCTION ODCIStatsIndexCost(ia sys.ODCIIndexInfo, sel NUMBER,
    cost OUT sys.ODCICost, qi sys.ODCIQueryInfo, pred sys.ODCIPredInfo,
    args sys.ODCIArgDescList, strt NUMBER, stop NUMBER, cmppos NUMBER,
    cmpval NUMBER, env sys.ODCIEnv)
    RETURN NUMBER,
  STATIC FUNCTION ODCIStatsIndexCost(ia sys.ODCIIndexInfo, sel NUMBER,
    cost OUT sys.ODCICost, qi sys.ODCIQueryInfo, pred sys.ODCIPredInfo,
    args sys.ODCIArgDescList, strt NUMBER, stop NUMBER, cmpval NUMBER,
    env sys.ODCIEnv)
    RETURN NUMBER,
  STATIC FUNCTION ODCIStatsFunctionCost(func sys.ODCIFuncInfo,
    cost OUT sys.ODCICost, args sys.ODCIArgDescList, object PowerDemand_Typ,
    cell NUMBER, value NUMBER, env sys.ODCIEnv)
    RETURN NUMBER,
  STATIC FUNCTION ODCIStatsFunctionCost(func sys.ODCIFuncInfo,
    cost OUT sys.ODCICost, args sys.ODCIArgDescList, object PowerDemand_Typ,
    value NUMBER, env sys.ODCIEnv)
    RETURN NUMBER,
  STATIC FUNCTION ODCIStatsFunctionCost(func sys.ODCIFuncInfo,
    cost OUT sys.ODCICost, args sys.ODCIArgDescList, object PowerDemand_Typ,
    cell NUMBER, value NUMBER, env sys.ODCIEnv)
    RETURN NUMBER
);
/

```

### 15.5.2.2 ODCIGetInterfaces()

The `ODCIGetInterfaces()` function, demonstrated in [Example 15-22](#), returns the list of names of the interfaces implemented by the type. There is only one set of the extensible optimizer interface routines, called `SYS.ODCISTATS`, but the server supports multiple versions of them for backward compatibility. To specify the current version of the routines, function `ODCIGetInterfaces()` must specify `SYS.ODCISTATS2` in the `OUT`, `ODCIObjectList` parameter.

#### Example 15-22 Registering interfaces and Statistics Functions for Power Demand Cartridge

```

STATIC FUNCTION ODCIGetInterfaces(
    ifclist OUT sys.ODCIObjectList)
RETURN NUMBER IS
BEGIN
    ifclist := sys.ODCIObjectList(sys.ODCIObject('SYS', 'ODCISTATS2'));
    RETURN ODCIConst.Success;
END ODCIGetInterfaces;

```

### 15.5.2.3 ODCIStatsCollect() Method for PowerDemand\_Typ Columns

The `ODCIStatsCollect()` function, demonstrated in [Example 15-23](#), collects statistics for columns whose data type is the `PowerDemand_Typ` object type. The statistics are collected for each cell in the column over all power grid readings. For a given cell, the statistics collected are the minimum and maximum power grid readings, and the number of non-null readings.

The function takes the column information as an object parameter whose type is `SYS.ODCICOLINFO`. The type attributes include the table name, column name, and so on. Options specified in the `DBMS_STATS` package command used to collect the column statistics are also passed in as parameters. Since the power demand cartridge uses a table to store the statistics, the output parameter `rawstats` is not used in this cartridge.

#### Example 15-23 Registering ODCIStatsCollect() for Power Demand Cartridge

```

STATIC FUNCTION ODCIStatsCollect(
    col sys.ODCIColInfo,
    options sys.ODCIStatsOptions,
    rawstats OUT RAW,
    env sys.ODCIEnv)
RETURN NUMBER IS
    cnum          INTEGER;
    stmt          VARCHAR2(1000);
    junk          INTEGER;
    cval          NUMBER;
    colname       VARCHAR2(30) := rtrim(ltrim(col.colName, ''), '');
    statsexists   BOOLEAN := FALSE;
    pdemands     PowerDemand_Tab%ROWTYPE;
    user_defined_stats PowerCartUserStats%ROWTYPE;

    CURSOR c1(tname VARCHAR2, cname VARCHAR2) IS
        SELECT * FROM PowerCartUserStats
        WHERE tab = tname AND col = cname;
    CURSOR c2 IS
        SELECT * FROM PowerDemand_Tab;

    BEGIN

```

```

sys.ODCIColInfoDump(col);
sys.ODCIStatsOptionsDump(options);

IF (col.TableSchema IS NULL OR col.TableName IS NULL OR col.ColName IS NULL)
THEN
    RETURN ODCIConst.Error;
END IF;

dbms_output.put_line('ODCIStatsCollect>>>>');
dbms_output.put_line('**** Analyzing column '||col.TableSchema|| '.' ||
    col.TableName|| '.' || col.ColName);

-- Check if statistics exist for this column
FOR user_defined_stats IN c1(col.TableName, colname) LOOP
    statsexists := TRUE;
    EXIT;
END LOOP;

```

The function checks whether statistics for this column exist. If so, it initializes them to NULL; otherwise, it creates statistics for each of the 100 cells and initializes them to NULL.

```

IF not statsexists THEN
    -- column statistics don't exist; create entries for each of the 100 cells
    cnum := dbms_sql.open_cursor;
    FOR i in 1..100 LOOP
        stmt := 'INSERT INTO PowerCartUserStats VALUES( '||''''|| col.TableName ||
            ''', '||''''||colname||''', '||to_char(i)||', '||'NULL, NULL, NULL)';
        dbms_sql.parse(cnum, stmt, dbms_sql.native);
        junk := dbms_sql.execute(cnum);
    END LOOP;
    dbms_sql.close_cursor(cnum);
ELSE
    -- column statistics exist; initialize to NULL
    cnum := dbms_sql.open_cursor;
    stmt := 'UPDATE PowerCartUserStats' ||
        ' SET lo = NULL, hi = NULL, nrows = NULL' || ' WHERE tab = ' ||
        col.TableName || ' AND col = ' || colname;
    dbms_sql.parse(cnum, stmt, dbms_sql.native);
    junk := dbms_sql.execute(cnum);
    dbms_sql.close_cursor(cnum);
END IF;

```

The function collects statistics for the column by reading rows from the table that is being analyzed. This is done by constructing and executing a SQL statement.

```

-- For each cell position, the following statistics are collected:
-- maximum value
-- minimum value
-- number of rows (excluding NULLs)
cnum := dbms_sql.open_cursor;
FOR i in 1..100 LOOP
    FOR pdemands IN c2 LOOP
        IF i BETWEEN pdemands.sample.CellDemandValues.FIRST AND
            pdemands.sample.CellDemandValues.LAST THEN
            cval := pdemands.sample.CellDemandValues(i);
            stmt := 'UPDATE PowerCartUserStats SET ' || 'lo = least(' || 'NVL(' ||
                to_char(cval)||', lo), ' || 'NVL(' || 'lo, ' || to_char(cval)||'))', ' ||
                'hi = greatest(' || 'NVL(' || to_char(cval)||', hi), ' || 'NVL(' ||
                'hi, ' || to_char(cval)||'))', ' ||
                'nrows = decode(nrows, NULL, decode(' || to_char(cval)||

```

```

        ', NULL, NULL, 1), decode('||to_char(cval)||
        ', NULL, nrows, nrows+1)) '||'WHERE cpos = '||to_char(i)||
        ' AND tab = ''||col.TableName||''||' AND col = ''||colname||
        ''';
        dbms_sql.parse(cnum, stmt, dbms_sql.native);
        junk := dbms_sql.execute(cnum);
    END IF;
END LOOP;
END LOOP;

```

The function concludes by closing the cursor and returning a success status.

```

        dbms_sql.close_cursor(cnum);
        rawstats := NULL;
        return ODCIConst.Success;

END ODCIStatsCollect;

```

### 15.5.2.4 ODCIStatsDelete() Method for PowerDemand\_Typ Columns

The `ODCIStatsDelete()` function, demonstrated in [Example 15-24](#), deletes statistics of columns whose data type is the `PowerDemand_Typ` object type. The function takes the column information as an object parameter whose type is `SYS.ODCICOLINFO`. The type attributes include the table name, column name, and so on.

#### Example 15-24 Registering ODCIStatsDelete() for Power Demand Cartridge

```

STATIC FUNCTION ODCIStatsDelete(
    col sys.ODCIColInfo,
    env sys.ODCIEnv)
RETURN NUMBER IS
    cnum          INTEGER;
    stmt          VARCHAR2(1000);
    junk          INTEGER;
    colname       VARCHAR2(30) := rtrim(ltrim(col.colName, ''), '');
    statsexists   BOOLEAN := FALSE;
    user_defined_stats PowerCartUserStats%ROWTYPE;

    CURSOR c1(tname VARCHAR2, cname VARCHAR2) IS
        SELECT * FROM PowerCartUserStats
        WHERE tab = tname AND col = cname;
    BEGIN
        sys.ODCIColInfoDump(col);

        IF (col.TableSchema IS NULL OR col.TableName IS NULL OR col.ColName IS NULL)
        THEN
            RETURN ODCIConst.Error;
        END IF;

        dbms_output.put_line('ODCIStatsDelete>>>>>');
        dbms_output.put_line('**** Analyzing (delete) column '|| col.TableSchema||
            '.' ||col.TableName||'.' ||col.ColName);

```

The function verifies that statistics for the column exist by checking the statistics table. If statistics were not collected, then there is nothing to be done. If, however, statistics are present, it constructs and executes a SQL statement to delete the relevant rows from the statistics table.

```

-- Check if statistics exist for this column
FOR user_defined_stats IN c1(col.TableName, colname) LOOP

```

```

statsexists := TRUE;
EXIT;
END LOOP;

-- If user-defined statistics exist, delete them
IF statsexists THEN
  stmt := 'DELETE FROM PowerCartUserStats' || ' WHERE tab = ''' || col.TableName ||
    ''' || ' AND col = ''' || colname || '''';
  cnum := dbms_sql.open_cursor;
  dbms_output.put_line('ODCIStatsDelete>>>>');
  dbms_output.put_line('ODCIStatsDelete>>>>' || stmt);
  dbms_sql.parse(cnum, stmt, dbms_sql.native);
  junk := dbms_sql.execute(cnum);
  dbms_sql.close_cursor(cnum);
END IF;

RETURN ODCIConst.Success;
END ODCIStatsDelete;

```

### 15.5.2.5 ODCIStatsCollect() Method for **power\_idxtype** Domain Indexes

The [ODCIStatsCollect\(\)](#) function, demonstrated in [Example 15-25](#), collects statistics for domain indexes whose indextype is `power_idxtype`. In the power demand cartridge, this function simply analyzes the index-organized table that stores the index data.

The function takes the index information as an object parameter whose type is `SYS.ODCIINDEXINFO`. The type attributes include the index name, owner name, and so on. Options specified by the `DBMS_STATS` package are used to collect the index statistics are also passed in as parameters. The output parameter `rawstats` is not used.

#### Example 15-25 Registering ODCIStatsCollect() for Power Demand Cartridge

```

STATIC FUNCTION ODCIStatsCollect (
  ia sys.ODCIIndexInfo,
  options sys.ODCIStatsOptions,
  rawstats OUT RAW,
  env sys.ODCIEnv)
RETURN NUMBER IS
  stmt          VARCHAR2(1000);

BEGIN
  -- To analyze a domain index, analyze the table that implements the index
  sys.ODCIIndexInfoDump(ia);
  sys.ODCIStatsOptionsDump(options);

  stmt := 'dbms_stats.gather_table_stats('
    || ''' || ia.IndexSchema || ''', '
    || ''' || ia.IndexName || '_pidx' || ''')';
  dbms_output.put_line('**** Analyzing index '
    || ia.IndexSchema || '.' || ia.IndexName);
  dbms_output.put_line('SQL Statement: ' || stmt);
  EXECUTE IMMEDIATE 'BEGIN ' || stmt || ' END;';
  rawstats := NULL;

  RETURN ODCIConst.Success;
END ODCIStatsCollect;

```

### 15.5.2.6 ODCIStatsDelete() Method for **power\_idxtype** Domain Indexes

The `ODCIStatsDelete()` function, demonstrated in [Example 15-26](#), deletes statistics for domain indexes whose `idxtype` is `power_idxtype`. In the power demand cartridge, this function simply deletes the statistics of the index-organized table that stores the index data.

The function takes the index information as an object parameter whose type is `SYS.ODCIINDEXINFO`. The type attributes include the index name, owner name, and so on.

#### Example 15-26 Registering `ODCIStatsDelete()` for Domain Indexes in Power Demand Cartridge

```

STATIC FUNCTION ODCIStatsDelete(
  ia sys.ODCIIndexInfo,
  env sys.ODCIEnv)
RETURN NUMBER IS
  stmt          VARCHAR2(1000);
BEGIN
  -- To delete statistics for a domain index, delete the statistics for the
  -- table implementing the index
  sys.ODCIIndexInfoDump(ia);
  stmt := 'dbms_stats.delete_table_stats(' || '''' || ia.IndexSchema || ''', '
        || '''' || ia.IndexName || '_pidx' || ''')';
  dbms_output.put_line('**** Analyzing (delete) index ' || ia.IndexSchema || '.' ||
    ia.IndexName);
  dbms_output.put_line('SQL Statement: ' || stmt);

  EXECUTE IMMEDIATE 'BEGIN ' || stmt || ' END;';
  RETURN ODCIConst.Success;
END ODCIStatsDelete;

```

### 15.5.2.7 ODCIStatsSelectivity() Method for **Specific** Queries

The first definition of the `ODCIStatsSelectivity()` function estimates the selectivity of operator or function predicates for *specific* queries. For example, if a query asks for all instances where cell (3,7) has a value equal to 25, the function estimates the percentage of rows in which the given cell has the specified value.

The `pred` parameter contains the function information (the functional implementation of an operator in an operator predicate); this parameter is an object instance of type `SYS.ODCIPREDINFO`. The selectivity is returned as a percentage in the `sel` output parameter. The `args` parameter (an object instance of type `SYS.ODCIARGDESCLIST`) contains a descriptor for each argument of the function, and the start and stop values of the function. For example, if an argument is a column, the argument descriptor contains the table name, column name, and so on. The `strt` and `stop` parameters are the lower and upper boundary points for the function return value. If the function in a predicate contains a literal of type `PowerDemand_Typ`, the `object` parameter contains the value in the form of an object constructor. The `cell` parameter is the cell position and the `value` parameter is the value in the cell specified by the function (`PowerXxxxxSpecific_Func`).

The selectivity is estimated by using a technique similar to that used for simple range predicates. For example, a simple estimate for the selectivity of a predicate like

```
c > v
```

is  $(M-v)/(M-m)$  where  $m$  and  $M$  are the minimum and maximum values, respectively, for the column  $c$  (as determined from the column statistics), provided the value  $v$  lies between  $m$  and  $M$ .

The `get_selectivity` function, demonstrated in [Example 15-27](#), computes the selectivity of a simple range predicate given the minimum and maximum values of the column in the predicate. It assumes that the column values in the table are uniformly distributed between the minimum and maximum values.

### Example 15-27 Implementing Selectivity Function for Power Demand Cartridge

```
CREATE FUNCTION get_selectivity(relop VARCHAR2, value NUMBER,
                             lo NUMBER, hi NUMBER, ndv NUMBER)
RETURN NUMBER AS
  sel NUMBER := NULL;
  ndv NUMBER;
BEGIN
  -- This function computes the selectivity (as a percentage)
  -- of a predicate
  --      col <relop> <value>
  -- where <relop> is one of: =, !=, <, <=, >, >=
  --      <value> is one of: 0, 1
  -- lo and hi are the minimum and maximum values of the column in
  -- the table. This function performs a simplistic estimation of the
  -- selectivity by assuming that the range of distinct values of
  -- the column is distributed uniformly in the range lo..hi and that
  -- each distinct value occurs nrows/(hi-lo+1) times (where nrows is
  -- the number of rows).

  IF ndv IS NULL OR ndv <= 0 THEN
    RETURN 0;
  END IF;

  -- col != <value>
  IF relop = '!=' THEN
    IF value between lo and hi THEN
      sel := 1 - 1/ndv;
    ELSE
      sel := 1;
    END IF;

  -- col = <value>
  ELSIF relop = '=' THEN
    IF value between lo and hi THEN
      sel := 1/ndv;
    ELSE
      sel := 0;
    END IF;

  -- col >= <value>
  ELSIF relop = '>=' THEN
    IF lo = hi THEN
      IF value <= lo THEN
        sel := 1;
      ELSE
        sel := 0;
      END IF;
    ELSIF value between lo and hi THEN
      sel := (hi-value)/(hi-lo) + 1/ndv;
    ELSIF value < lo THEN
      sel := 1;
    END IF;
  END IF;
```

```
ELSE
    sel := 0;
END IF;

-- col < <value>
ELSIF relop = '<' THEN
    IF lo = hi THEN
        IF value > lo THEN
            sel := 1;
        ELSE
            sel := 0;
        END IF;
    ELSIF value between lo and hi THEN
        sel := (value-lo)/(hi-lo);
    ELSIF value < lo THEN
        sel := 0;
    ELSE
        sel := 1;
    END IF;

-- col <= <value>
ELSIF relop = '<=' THEN
    IF lo = hi THEN
        IF value >= lo THEN
            sel := 1;
        ELSE
            sel := 0;
        END IF;
    ELSIF value between lo and hi THEN
        sel := (value-lo)/(hi-lo) + 1/ndv;
    ELSIF value < lo THEN
        sel := 0;
    ELSE
        sel := 1;
    END IF;

-- col > <value>
ELSIF relop = '>' THEN
    IF lo = hi THEN
        IF value < lo THEN
            sel := 1;
        ELSE
            sel := 0;
        END IF;
    ELSIF value between lo and hi THEN
        sel := (hi-value)/(hi-lo);
    ELSIF value < lo THEN
        sel := 1;
    ELSE
        sel := 0;
    END IF;

END IF;

RETURN least(100, ceil(100*sel));

END;
/
```

The `ODCIStatsSelectivity()` function, demonstrated in [Example 15-28](#), estimates the selectivity for function predicates which have constant start and stop values. Further,



the first argument of the function in the predicate must be a column of type `PowerDemand_Typ` and the remaining arguments must be constants.

### Example 15-28 Registering `ODCIStatsSelectivity()` for Queries for Power Demand Cartridge

```

STATIC FUNCTION ODCIStatsSelectivity(pred sys.ODCIPredInfo,
  sel OUT NUMBER, args sys.ODCIArgDescList, strt NUMBER, stop NUMBER,
  object PowerDemand_Typ, cell NUMBER, value NUMBER, env sys.ODCIEnv)
RETURN NUMBER IS
  fname          varchar2(30);
  relop          varchar2(2);
  lo             NUMBER;
  hi             NUMBER;
  nrows         NUMBER;
  colname       VARCHAR2(30);
  statsexists    BOOLEAN := FALSE;
  stats          PowerCartUserStats%ROWTYPE;
  CURSOR c1(cell NUMBER, tname VARCHAR2, cname VARCHAR2) IS
    SELECT * FROM PowerCartUserStats
      WHERE cpos = cell
             AND tab = tname
             AND col = cname;
BEGIN
  -- compute selectivity only when predicate is of the form:
  --   fn(col, <cell>, <value>) <relop> <val>
  -- In all other cases, return an error and let the optimizer
  -- make a guess. We also assume that the function "fn" has
  -- a return value of 0, 1, or NULL.

  -- start value
  IF (args(1).ArgType != ODCIConst.ArgLit AND
      args(1).ArgType != ODCIConst.ArgNull) THEN
    RETURN ODCIConst.Error;
  END IF;

  -- stop value
  IF (args(2).ArgType != ODCIConst.ArgLit AND
      args(2).ArgType != ODCIConst.ArgNull) THEN
    RETURN ODCIConst.Error;
  END IF;

  -- first argument of function
  IF (args(3).ArgType != ODCIConst.ArgCol) THEN
    RETURN ODCIConst.Error;
  END IF;

  -- second argument of function
  IF (args(4).ArgType != ODCIConst.ArgLit AND
      args(4).ArgType != ODCIConst.ArgNull) THEN
    RETURN ODCIConst.Error;
  END IF;

  -- third argument of function
  IF (args(5).ArgType != ODCIConst.ArgLit AND
      args(5).ArgType != ODCIConst.ArgNull) THEN
    RETURN ODCIConst.Error;
  END IF;

  colname := rtrim(ltrim(args(3).colName, ''), '');

```

The first (column) argument of the function in the predicate must have statistics collected for it. If statistics have not been collected, `ODCIStatsSelectivity()` returns an error status.

```
-- Check if the statistics table exists (we are using a
-- user-defined table to store the user-defined statistics).
-- Get user-defined statistics: MIN, MAX, NROWS
FOR stats IN c1(cell, args(3).TableName, colname) LOOP
  -- Get user-defined statistics: MIN, MAX, NROWS
  lo := stats.lo;
  hi := stats.hi;
  nrows := stats.nrows;
  statsexists := TRUE;
  EXIT;
END LOOP;

-- If no user-defined statistics were collected, return error
IF not statsexists THEN
  RETURN ODCIConst.Error;
END IF;
```

Each `Specific` function predicate corresponds to an equivalent range predicate. For example, the predicate `Power_EqualsSpecific_Func(col, 21, 25) = 0`, which checks that the reading in cell 21 is not equal to 25, corresponds to the equivalent range predicate `col[21] != 25`.

The `ODCIStatsSelectivity()` function finds the corresponding range predicates for each `Specific` function predicate. There are several boundary cases where the selectivity can be immediately determined.

```
-- selectivity is 0 for "fn(col, <cell>, <value>) < 0"
IF (stop = 0 AND
    bitand(pred.Flags, ODCIConst.PredIncludeStop) = 0) THEN
  sel := 0;
  RETURN ODCIConst.Success;
END IF;

-- selectivity is 0 for "fn(col, <cell>, <value>) > 1"
IF (strt = 1 AND
    bitand(pred.Flags, ODCIConst.PredIncludeStart) = 0) THEN
  sel := 0;
  RETURN ODCIConst.Success;
END IF;

-- selectivity is 100% for "fn(col, <cell>, <value>) >= 0"
IF (strt = 0 AND
    bitand(pred.Flags, ODCIConst.PredExactMatch) = 0 AND
    bitand(pred.Flags, ODCIConst.PredIncludeStart) > 0) THEN
  sel := 100;
  RETURN ODCIConst.Success;
END IF;

-- selectivity is 100% for "fn(col, <cell>, <value>) <= 1"
IF (stop = 1 AND
    bitand(pred.Flags, ODCIConst.PredExactMatch) = 0 AND
    bitand(pred.Flags, ODCIConst.PredIncludeStop) > 0) THEN
  sel := 100;
  RETURN ODCIConst.Success;
END IF;

-- get function name
```

```

IF bitand(pred.Flags, ODCIConst.PredObjectFunc) > 0 THEN
    fname := pred.ObjectName;
ELSE
    fname := pred.MethodName;
END IF;

-- convert prefix relational operator to infix:
-- "Power_EqualsSpecific_Func(col, <cell>, <value>) = 1"
-- becomes "col[<cell>] = <value>"

-- Power_EqualsSpecific_Func(col, <cell>, <value>) = 0
-- Power_EqualsSpecific_Func(col, <cell>, <value>) <= 0
-- Power_EqualsSpecific_Func(col, <cell>, <value>) < 1
-- can be transformed to
-- col[<cell>] != <value>
IF (fname LIKE upper('Power_Equals%') AND
    (stop = 0 OR
     (stop = 1 AND
      bitand(pred.Flags, ODCIConst.PredIncludeStop) = 0))) THEN
    relop := '!=';

-- Power_LessThanSpecific_Func(col, <cell>, <value>) = 0
-- Power_LessThanSpecific_Func(col, <cell>, <value>) <= 0
-- Power_LessThanSpecific_Func(col, <cell>, <value>) < 1
-- can be transformed to
-- col[<cell>] >= <value>
ELSIF (fname LIKE upper('Power_LessThan%') AND
        (stop = 0 OR
         (stop = 1 AND
          bitand(pred.Flags, ODCIConst.PredIncludeStop) = 0))) THEN
    relop := '>=';

-- Power_GreaterThanSpecific_Func(col, <cell>, <value>) = 0
-- Power_GreaterThanSpecific_Func(col, <cell>, <value>) <= 0
-- Power_GreaterThanSpecific_Func(col, <cell>, <value>) < 1
-- can be transformed to
-- col[<cell>] <= <value>
ELSIF (fname LIKE upper('Power_GreaterThan%') AND
        (stop = 0 OR
         (stop = 1 AND
          bitand(pred.Flags, ODCIConst.PredIncludeStop) = 0))) THEN
    relop := '<=';

-- Power_EqualsSpecific_Func(col, <cell>, <value>) = 1
-- Power_EqualsSpecific_Func(col, <cell>, <value>) >= 1
-- Power_EqualsSpecific_Func(col, <cell>, <value>) > 0
-- can be transformed to
-- col[<cell>] = <value>
ELSIF (fname LIKE upper('Power_Equals%') AND
        (strt = 1 OR
         (strt = 0 AND
          bitand(pred.Flags, ODCIConst.PredIncludeStart) = 0))) THEN
    relop := '=';

-- Power_LessThanSpecific_Func(col, <cell>, <value>) = 1
-- Power_LessThanSpecific_Func(col, <cell>, <value>) >= 1
-- Power_LessThanSpecific_Func(col, <cell>, <value>) > 0
-- can be transformed to
-- col[<cell>] < <value>
ELSIF (fname LIKE upper('Power_LessThan%') AND
        (strt = 1 OR

```

```

        (strt = 0 AND
         bitand(pred.Flags, ODCIConst.PredIncludeStart) = 0)) THEN
    relop := '<';

    -- Power_GreaterThanSpecific_Func(col, <cell>, <value>) = 1
    -- Power_GreaterThanSpecific_Func(col, <cell>, <value>) >= 1
    -- Power_GreaterThanSpecific_Func(col, <cell>, <value>) > 0
    -- can be transformed to
    -- col[<cell>] > <value>
    ELSIF (fname LIKE upper('Power_GreaterThan%') AND
           (strt = 1 OR
            (strt = 0 AND
             bitand(pred.Flags, ODCIConst.PredIncludeStart) = 0))) THEN
        relop := '>';

    ELSE
        RETURN ODCIConst.Error;

    END IF;

```

After the `Specific` function predicate is transformed into a simple range predicate, `ODCIStatsSelectivity()` calls `get_selectivity` to compute the selectivity for the range predicate (and thus, equivalently, for the `Specific` function predicate). It returns with a success status.

```

    sel := get_selectivity(relop, value, lo, hi, nrows);
    RETURN ODCIConst.Success;
END;

```

### 15.5.2.8 ODCIStatsIndexCost() Method for **Specific** Queries

The first definition of the `ODCIStatsIndexCost()` function, demonstrated in [Example 15-29](#), estimates the cost of the domain index for `Specific` queries. For example, if a query asks for all instances where cell (3,7) has a value equal to 25, the function estimates the cost of the domain index access path to evaluate this query. This definition of `ODCIStatsIndexCost()` differs from the definition in `ODCIStatsIndexCost() Method for Any Queries` in that it includes the `cmppos` parameter for the position of the cell.

The `ia` parameter contains the index information as an object instance of type `SYS.ODCIINDEXINFO`. The `sel` parameter is the selectivity of the operator predicate as estimated by the `ODCIStatsSelectivity()` function for `Specific` queries. The estimated cost is returned in the `cost` output parameter. The `qi` parameter contains some information about the query and its environment, such as whether the `ALL_ROWS` or `FIRST_ROWS` optimizer mode is being used. The `pred` parameter contains the operator information as an object instance of type `SYS.ODCIPREDINFO`. The `args` parameter contains descriptors of the value arguments of the operator, and the start and stop values of the operator. The `strt` and `stop` parameters are the lower and upper boundary points for the operator return value. The `cmppos` parameter is the cell position and `cmpval` is the value in the cell specified by the operator `Power_XxxxxSpecific()`.

In the power demand cartridge, the domain index cost for `Specific` queries is identical to the domain index cost for `Any` queries, so this version of the `ODCIStatsIndexCost()` function simply calls the second definition of the function, described in `ODCIStatsIndexCost() Method for Any Queries`.

**Example 15-29 Registering ODCIStatsIndexCost() for Queries for Power Demand Cartridge**

```

STATIC FUNCTION ODCIStatsIndexCost(ia sys.ODCIIndexInfo,
    sel NUMBER, cost OUT sys.ODCICost, qi sys.ODCIQueryInfo,
    pred sys.ODCIPredInfo, args sys.ODCIArgDescList,
    strt NUMBER, stop NUMBER, cmppos NUMBER, cmpval NUMBER, env sys.ODCIEnv)
RETURN NUMBER IS
BEGIN
    -- This is the cost for queries on a specific cell; simply
    -- use the cost for queries on any cell.
    RETURN ODCIStatsIndexCost(ia, sel, cost, qi, pred, args,
        strt, stop, cmpval, env);
END;

```

 **See Also:**

- [ODCIStatsIndexCost\(\)](#)
- [ODCIStatsIndexCost\(\) Method for Any Queries](#)
- [ODCIStatsSelectivity\(\)](#)

### 15.5.2.9 ODCIStatsIndexCost() Method for Any Queries

The second definition of the `ODCIStatsIndexCost()` function, demonstrated in [Example 15-30](#), estimates the cost of the domain index for *Any* queries. For example, if a query asks for all instances where any cell has a value equal to 25, the function estimates the cost of the domain index access path to evaluate this query. This definition of `ODCIStatsIndexCost()` differs from the definition in `ODCIStatsIndexCost()` Method for Specific Queries in that it does not include the `cmppos` parameter.

The `ia` parameter contains the index information as an object instance of type `SYS.ODCIINDEXINFO`. The `sel` parameter is the selectivity of the operator predicate as estimated by the `ODCIStatsSelectivity()` function for *Any* queries. The estimated cost is returned in the `cost` output parameter. The `qi` parameter contains some information about the query and its environment, such as whether the `ALL_ROWS` or `FIRST_ROWS` optimizer mode is being used. The `pred` parameter contains the operator information as an object instance of type `SYS.ODCIPREDINFO`. The `args` parameter contains descriptors of the value arguments of the operator, and the start and stop values of the operator. The `strt` and `stop` parameters are the lower and upper boundary points for the operator return value. The `cmpval` parameter is the value in the cell specified by the operator `Power_XxxxxAny()`.

The index cost is estimated as the number of blocks in the index-organized table implementing the index multiplied by the selectivity of the operator predicate times a constant factor.

**Example 15-30 Registering ODCIStatsIndexCost() for Any Queries for Power Demand Cartridge**

```

STATIC FUNCTION ODCIStatsIndexCost(ia sys.ODCIIndexInfo,
    sel NUMBER, cost OUT sys.ODCICost, qi sys.ODCIQueryInfo,
    pred sys.ODCIPredInfo, args sys.ODCIArgDescList,
    strt NUMBER, stop NUMBER, cmpval NUMBER, env sys.ODCIEnv)
RETURN NUMBER IS

```

```

ixtable          VARCHAR2(40);
numblocks        NUMBER := NULL;
get_table        user_tables%ROWTYPE;
CURSOR c1(tab VARCHAR2) IS
    SELECT * FROM user_tables WHERE table_name = tab;
BEGIN
    -- This is the cost for queries on any cell.

    -- To compute the cost of a domain index, multiply the
    -- number of blocks in the table implementing the index
    -- with the selectivity

    -- Return if we don't have predicate selectivity
    IF sel IS NULL THEN
        RETURN ODCIConst.Error;
    END IF;

    cost := sys.ODCICost(NULL, NULL, NULL, NULL);

    -- Get name of table implementing the domain index
    ixtable := ia.IndexName || '_pidx';

    -- Get number of blocks in domain index
    FOR get_table IN c1(upper(ixtable)) LOOP
        numblocks := get_table.blocks;
        EXIT;
    END LOOP;

    IF numblocks IS NULL THEN
        -- Exit if there are no user-defined statistics for the index
        RETURN ODCIConst.Error;
    END IF;

    cost.CPUCost := ceil(400*(sel/100)*numblocks);
    cost.IOCost := ceil(1.5*(sel/100)*numblocks);
    RETURN ODCIConst.Success;
END;

```

#### See Also:

- [ODCIStatsIndexCost\(\)](#)
- [ODCIStatsIndexCost\(\) Method for Specific Queries](#)
- [ODCIStatsSelectivity\(\)](#)

### 15.5.2.10 ODCIStatsFunctionCost() Method

The [ODCIStatsFunctionCost\(\)](#) function, demonstrated in [Example 15-31](#), estimates the cost of evaluating a function `Power_XxxxxSpecific_Func()` or `Power_XxxxxAny_Func()`.

The `func` parameter contains the function information; this parameter is an object instance of type `SYS.ODCIFUNCINFO`. The estimated cost is returned in the output `cost` parameter. The `args` parameter as an object instance of type `SYS.ODCIARGDESCLIST` contains a descriptor for each argument of the function. If the function contains a literal of type `PowerDemand_Typ` as its first argument, the `object` parameter contains the value

in the form of an object constructor. The `value` parameter is the value in the cell specified by the function `PowerXXXXSpecific_Func()` or `Power_XXXXAny_Func()`.

The function cost is simply estimated as some default value depending on the function name. Since the functions do not read any data from disk, the I/O cost is set to zero.

### Example 15-31 Registering ODCIStatsFunctionCost() for Power Demand Cartridge

```

STATIC FUNCTION ODCIStatsFunctionCost(func sys.ODCIFuncInfo,
    cost OUT sys.ODCICost, args sys.ODCIArgDescList,
    object PowerDemand_Typ, value NUMBER, env sys.ODCIEnv)
    RETURN NUMBER IS
    fname          VARCHAR2(30);
BEGIN
    cost := sys.ODCICost(NULL, NULL, NULL, NULL);

    -- Get function name
    IF bitand(func.Flags, ODCIConst.ObjectFunc) > 0 THEN
        fname := func.ObjectName;
    ELSE
        fname := func.MethodName;
    END IF;

    IF fname LIKE upper('Power_LessThan%') THEN
        cost.CPUCost := 5000;
        cost.IOCost := 0;
        RETURN ODCIConst.Success;
    ELSIF fname LIKE upper('Power_Equals%') THEN
        cost.CPUCost := 7000;
        cost.IOCost := 0;
        RETURN ODCIConst.Success;
    ELSIF fname LIKE upper('Power_GreaterThan%') THEN
        cost.CPUCost := 5000;
        cost.IOCost := 0;
        RETURN ODCIConst.Success;
    ELSE
        RETURN ODCIConst.Error;
    END IF;
END;

```

## 15.5.3 Associating the Extensible Optimizer Methods with Database Objects

In order for the optimizer to use the methods defined in the `power_statistics` object type, they have to be associated with the appropriate database objects, as demonstrated in [Example 15-32](#).

### Example 15-32 Using Statistics Methods with Database Objects for Power Demand Cartridge

```

Associate statistics type with types, indextypes, and functions
ASSOCIATE STATISTICS WITH TYPES PowerDemand_Typ USING power_statistics;
ASSOCIATE STATISTICS WITH INDEXTYPES power_idxtype USING power_statistics
WITH SYSTEM MANAGED STORAGE TABLES;
ASSOCIATE STATISTICS WITH FUNCTIONS
    Power_EqualsSpecific_Func,
    Power_GreaterThanSpecific_Func,
    Power_LessThanSpecific_Func,

```

```
Power_EqualsAny_Func,  
Power_GreaterThanAny_Func,  
Power_LessThanAny_Func  
USING power_statistics;
```

## 15.5.4 Analyzing the Database Objects

Analyzing tables, columns, and indexes ensures that the optimizer has the relevant statistics to estimate accurate costs for various access paths and choose a good plan. Further, the selectivity and cost functions defined in the `power_statistics` object type rely on the presence of statistics. [Example 15-33](#) demonstrates statements that analyze the database objects and verify that statistics were indeed collected.

### Example 15-33 Analyzing Database Objects for the Power Demand Cartridge

```
-- Analyze the table  
EXECUTE dbms_stats.gather_table_stats(  
    'POWERCARTUSER', 'POWERDEMAND_TAB', cascade => TRUE);  
  
-- Verify that user-defined statistics were collected  
SELECT tab tablename, col colname, cpos, lo, hi, nrows  
FROM PowerCartUserStats  
WHERE nrows IS NOT NULL  
ORDER BY cpos;  
  
-- Delete the statistics  
EXECUTE dbms_stats.delete_table_stats('POWERCARTUSER', 'POWERDEMAND_TAB');  
  
-- Verify that user-defined statistics were deleted  
SELECT tab tablename, col colname, cpos, lo, hi, nrows  
FROM PowerCartUserStats  
WHERE nrows IS NOT NULL  
ORDER BY cpos;  
  
-- Re-analyze the table  
EXECUTE dbms_stats.gather_table_stats(  
    'POWERCARTUSER', 'POWERDEMAND_TAB', cascade => TRUE);  
  
-- Verify that user-defined statistics were re-collected  
SELECT tab tablename, col colname, cpos, lo, hi, nrows  
FROM PowerCartUserStats  
WHERE nrows IS NOT NULL  
ORDER BY cpos;
```

## 15.6 Testing the Domain Index

Consider the parts of the power demand example that perform some simple tests of the domain index, and how to test the domain index and see if it is causing more efficient execution of queries than would occur without an index. These tests consist of:

- Creating the power demand table (`PowerDemand_Tab`) and populating it with a small amount of data
- Executing some queries before the index is created (and showing the execution plans without an index being used)

The execution plans show that a full table scan is performed in each case.



- Creating the index on the grid
- Executing the same queries after the index is created (and showing the execution plans with the index being used)

The execution plans show that Oracle is using the index and not performing full table scans, thus resulting in more efficient execution.

The statements described here are available online in the example file (tkqxpwr.sql).

## 15.6.1 Creating and Populating the Power Demand Table

The power demand table, as demonstrated in [Example 15-34](#), is created with two columns:

- `region` allows the electric utility to use the grid scheme in multiple areas or states. Each region, such as New York, New Jersey, Pennsylvania, and so on, is represented by a 10x10 grid.
- `sample` is a collection of samplings, or power demand readings from each cell in the grid, defined using the `PowerDemand_Typ` object type.

Several rows are inserted, representing power demand data for two regions, 1 and 2, for several hourly timestamps. For simplicity, values are inserted only into the first 5 positions of each grid; the remaining 95 values are set to `null`, as demonstrated in [Example 15-35](#).

Finally, the values for `TotGridDemand`, `MaxCellDemand`, and `MinCellDemand` are computed and set for each of the newly inserted rows, and these values are displayed, as demonstrated in [Example 15-36](#).

### Example 15-34 Creating PowerDemand\_Tab Table for Power Demand Cartridge

```
CREATE TABLE PowerDemand_Tab (
  -- Region for which these power demand readings apply
  region NUMBER,
  -- Values for each "sampling" time (for a given hour)
  sample PowerDemand_Typ
);
```

### Example 15-35 Populating PowerDemand\_Tab Table for Power Demand Cartridge

```
-- The next INSERT statements "cheats" by supplying only 5 grid values
-- First 5 INSERT statements are for region 1 (1 AM to 5 AM on 01-Feb-1998).

INSERT INTO PowerDemand_Tab VALUES(1,
  PowerDemand_Typ(NULL, NULL, NULL, PowerGrid_Typ(55,8,13,9,5),
  to_date('02-01-1998 01','MM-DD-YYYY HH'))
);

INSERT INTO PowerDemand_Tab VALUES(1,
  PowerDemand_Typ(NULL, NULL, NULL, PowerGrid_Typ(56,8,13,9,3),
  to_date('02-01-1998 02','MM-DD-YYYY HH'))
);

INSERT INTO PowerDemand_Tab VALUES(1,
  PowerDemand_Typ(NULL, NULL, NULL, PowerGrid_Typ(55,8,13,9,3),
  to_date('02-01-1998 03','MM-DD-YYYY HH'))
);
```

```

INSERT INTO PowerDemand_Tab VALUES(1,
    PowerDemand_Typ(NULL, NULL, NULL, PowerGrid_Typ(54,8,13,9,3),
    to_date('02-01-1998 04','MM-DD-YYYY HH'))
);

INSERT INTO PowerDemand_Tab VALUES(1,
    PowerDemand_Typ(NULL, NULL, NULL, PowerGrid_Typ(54,8,12,9,3),
    to_date('02-01-1998 05','MM-DD-YYYY HH'))
);

-- Also insert some rows for region 2.

INSERT INTO PowerDemand_Tab VALUES(2,
    PowerDemand_Typ(NULL, NULL, NULL, PowerGrid_Typ(9,8,11,16,5),
    to_date('02-01-1998 01','MM-DD-YYYY HH'))
);

INSERT INTO PowerDemand_Tab VALUES(2,
    PowerDemand_Typ(NULL, NULL, NULL, PowerGrid_Typ(9,8,11,20,5),
    to_date('02-01-1998 02','MM-DD-YYYY HH'))
);

```

### Example 15-36 Computing Grid and Cell Demands for Power Demand Cartridge

```

DECLARE
CURSOR c1 IS SELECT Sample, Region FROM PowerDemand_Tab FOR UPDATE;
s PowerDemand_Typ;
r NUMBER;
BEGIN
    OPEN c1;
    LOOP
        FETCH c1 INTO s,r;
        EXIT WHEN c1%NOTFOUND;
        s.SetTotalDemand;
        s.SetMaxDemand;
        s.SetMinDemand;
        dbms_output.put_line(s.TotGridDemand);
        dbms_output.put_line(s.MaxCellDemand);
        dbms_output.put_line(s.MinCellDemand);
        UPDATE PowerDemand_Tab SET Sample = s WHERE CURRENT OF c1;
    END LOOP;
    CLOSE c1;
END;
/

-- Examine the values.
SELECT region, P.Sample.TotGridDemand, P.Sample.MaxCellDemand,
    P.Sample.MinCellDemand,
    to_char(P.sample.sampletime, 'MM-DD-YYYY HH')
FROM PowerDemand_Tab P;

```

## 15.6.2 Querying Without the Index

The queries used here are executed by applying the underlying function `PowerEqualsSpecific_Func()` for every row in the table, because the index has not yet been defined.

The example file includes queries that check, both for a specific cell number and for any cell number, for values equal to, greater than, and less than a specified value. For example, the equality queries are demonstrated in [Example 15-37](#).

The execution plans show that a full table scan is performed in each case:

OPERATIONS	OPTIONS	OBJECT_NAME
-----	-----	-----
SELECT STATEMENT		
TABLE ACCESS	FULL	POWERDEMAND_TAB

### Example 15-37 Making Equality Queries for Power Demand Cartridge

```

SET SERVEROUTPUT ON
-----
-- Query, referencing the operators (without index)
-----
explain plan for
SELECT P.Region, P.Sample.TotGridDemand ,P.Sample.MaxCellDemand,
       P.Sample.MinCellDemand
FROM PowerDemand_Tab P
WHERE Power_Equals(P.Sample,2,10) = 1;
@tkoqxpl1

SELECT P.Region, P.Sample.TotGridDemand ,P.Sample.MaxCellDemand,
       P.Sample.MinCellDemand
FROM PowerDemand_Tab P
WHERE Power_Equals(P.Sample,2,10) = 1;

explain plan for
SELECT P.Region, P.Sample.TotGridDemand ,P.Sample.MaxCellDemand,
       P.Sample.MinCellDemand
FROM PowerDemand_Tab P
WHERE Power_Equals(P.Sample,1,25) = 1;
@tkoqxpl1

SELECT P.Region, P.Sample.TotGridDemand ,P.Sample.MaxCellDemand,
       P.Sample.MinCellDemand
FROM PowerDemand_Tab P
WHERE Power_Equals(P.Sample,1,25) = 1;

explain plan for
SELECT P.Region, P.Sample.TotGridDemand ,P.Sample.MaxCellDemand,
       P.Sample.MinCellDemand
FROM PowerDemand_Tab P
WHERE Power_Equals(P.Sample,2,8) = 1;
@tkoqxpl1

SELECT P.Region, P.Sample.TotGridDemand ,P.Sample.MaxCellDemand,
       P.Sample.MinCellDemand
FROM PowerDemand_Tab P
WHERE Power_Equals(P.Sample,2,8) = 1;

explain plan for
SELECT P.Region, P.Sample.TotGridDemand ,P.Sample.MaxCellDemand,
       P.Sample.MinCellDemand
FROM PowerDemand_Tab P
WHERE Power_EqualsAny(P.Sample,9) = 1;
@tkoqxpl1

SELECT P.Region, P.Sample.TotGridDemand ,P.Sample.MaxCellDemand,

```

```

P.Sample.MinCellDemand
FROM PowerDemand_Tab P
WHERE Power_EqualsAny(P.Sample,9) = 1;

```

### 15.6.3 Creating the Index

The index is created on the `Sample` column in the power demand table, as demonstrated in [Example 15-38](#).

#### Example 15-38 Creating an Index in PowerDemand\_Tab Table for Power Demand Cartridge

```

CREATE INDEX PowerIndex ON PowerDemand_Tab(Sample)
INDEXTYPE IS power_idxtype;

```

### 15.6.4 Querying with the Index

The queries used here are identical to those in "[Querying Without the Index](#)", but this time the index is used.

The execution plans show that Oracle is using the domain index and not performing full table scans, thus resulting in more efficient execution, as demonstrated in [Example 15-39](#).

#### Example 15-39 Making Equality Queries with Index for Power Demand Cartridge

```

SQLPLUS> -----
SQLPLUS> -- Query, referencing the operators (with index)
SQLPLUS> -----
SQLPLUS> explain plan for
  2> SELECT P.Region, P.Sample.TotGridDemand ,P.Sample.MaxCellDemand,
  3>       P.Sample.MinCellDemand
  4> FROM PowerDemand_Tab P
  5> WHERE Power_Equals(P.Sample,2,10) = 1;
Statement processed.
SQLPLUS> @tkoqxpl1
SQLPLUS> set echo off
Echo                                OFF
Charwidth                            15
OPERATIONS      OPTIONS      OBJECT_NAME
-----
SELECT STATEMEN
TABLE ACCESS    BY ROWID      POWERDEMAND_TAB
DOMAIN INDEX    POWERINDEX
3 rows selected.
Statement processed.
Echo                                ON
SQLPLUS>
SQLPLUS> SELECT P.Region, P.Sample.TotGridDemand ,P.Sample.MaxCellDemand,
  2>       P.Sample.MinCellDemand
  3> FROM PowerDemand_Tab P
  4> WHERE Power_Equals(P.Sample,2,10) = 1;
REGION      SAMPLE.TOT  SAMPLE.MAX  SAMPLE.MIN
-----
0 rows selected.
ODCIIndexStart>>>>>
ODCIIndexInfo
Index owner : POWERCARTUSER
Index name  : POWERINDEX

```

```

Table owner : POWERCARTUSER
Table name : POWERDEMAND_TAB
Indexed column : "SAMPLE"
Indexed column type :POWERDEMAND_TYP
Indexed column type schema:POWERCARTUSER
ODCIPredInfo
Object owner : POWERCARTUSER
Object name : POWER_EQUALS
Method name :
Predicate bounds flag :
    Exact Match
    Include Start Key
    Include Stop Key
start key : 1
stop key : 1
compare position : 2
compare value : 10
ODCIIndexStart>>>>select r from POWERCARTUSER.POWERINDEX_pidx where cpos ='2' and
cval ='10'
ODCIIndexFetch>>>>
Nrows : 2000
ODCIIndexClose>>>>
SQLPLUS>
SQLPLUS> explain plan for
    2> SELECT P.Region, P.Sample.TotGridDemand ,P.Sample.MaxCellDemand,
    3>     P.Sample.MinCellDemand
    4>     FROM PowerDemand_Tab P
    5>     WHERE Power_Equals(P.Sample,2,8) = 1;
Statement processed.
SQLPLUS> @tkoqxpl1
SQLPLUS> set echo off
Echo                                OFF
Charwidth                            15
OPERATIONS      OPTIONS              OBJECT_NAME
-----
SELECT STATEMEN
TABLE ACCESS    BY ROWID              POWERDEMAND_TAB
DOMAIN INDEX   POWERINDEX
3 rows selected.
Statement processed.
Echo                                ON
SQLPLUS>
SQLPLUS> SELECT P.Region, P.Sample.TotGridDemand ,P.Sample.MaxCellDemand,
    2>     P.Sample.MinCellDemand
    3>     FROM PowerDemand_Tab P
    4>     WHERE Power_Equals(P.Sample,2,8) = 1;
REGION      SAMPLE.TOT  SAMPLE.MAX  SAMPLE.MIN
-----
          1          90          55          5
          1          89          56          3
          1          88          55          3
          1          87          54          3
          1          86          54          3
          2          49          16          5
          2          53          20          5
7 rows selected.
ODCIIndexStart>>>>
ODCIIndexInfo
Index owner : POWERCARTUSER
Index name : POWERINDEX
Table owner : POWERCARTUSER

```

```

Table name : POWERDEMAND_TAB
Indexed column : "SAMPLE"
Indexed column type :POWERDEMAND_TYP
Indexed column type schema:POWERCARTUSER
ODCIPredInfo
Object owner : POWERCARTUSER
Object name : POWER_EQUALS
Method name :
Predicate bounds flag :
    Exact Match
    Include Start Key
    Include Stop Key
start key : 1
stop key : 1
compare position : 2
compare value : 8
ODCIIndexStart>>>>select r from POWERCARTUSER.POWERINDEX_pidx where cpos ='2' and
cval ='8'
ODCIIndexFetch>>>>
Nrows : 2000
ODCIIndexClose>>>>
SQLPLUS>
SQLPLUS> explain plan for
    2> SELECT P.Region, P.Sample.TotGridDemand ,P.Sample.MaxCellDemand,
    3>     P.Sample.MinCellDemand
    4>     FROM PowerDemand_Tab P
    5>     WHERE Power_EqualsAny(P.Sample,9) = 1;
Statement processed.
SQLPLUS> @tkoqxpl1
SQLPLUS> set echo off
Echo                                OFF
Charwidth                            15
OPERATIONS      OPTIONS      OBJECT_NAME
-----
SELECT STATEMEN
TABLE ACCESS    BY ROWID      POWERDEMAND_TAB
DOMAIN INDEX    POWERINDEX
3 rows selected.
Statement processed.
Echo                                ON
SQLPLUS>
SQLPLUS> SELECT P.Region, P.Sample.TotGridDemand ,P.Sample.MaxCellDemand,
    2>     P.Sample.MinCellDemand
    3>     FROM PowerDemand_Tab P
    4>     WHERE Power_EqualsAny(P.Sample,9) = 1;
REGION      SAMPLE.TOT  SAMPLE.MAX  SAMPLE.MIN
-----
          1          90          55          5
          1          89          56          3
          1          88          55          3
          1          87          54          3
          1          86          54          3
          2          49          16          5
          2          53          20          5
7 rows selected.
ODCIIndexStart>>>>
ODCIIndexInfo
Index owner : POWERCARTUSER
Index name : POWERINDEX
Table owner : POWERCARTUSER
Table name : POWERDEMAND_TAB

```

```

Indexed column : "SAMPLE"
Indexed column type :POWERDEMAND_TYP
Indexed column type schema:POWERCARTUSER
ODCIPredInfo
Object owner : POWERCARTUSER
Object name : POWER_EQUALSANY
Method name :
Predicate bounds flag :
    Exact Match
    Include Start Key
    Include Stop Key
start key : 1
stop key : 1
compare value : 9
ODCIIndexStart>>>>select distinct r from POWERCARTUSER.POWERINDEX_pidx where cval
='9'
ODCIIndexFetch>>>>
Nrows : 2000
ODCIIndexClose>>>>
SQLPLUS>
SQLPLUS> explain plan for
    2> SELECT P.Region, P.Sample.TotGridDemand ,P.Sample.MaxCellDemand,
    3>     P.Sample.MinCellDemand
    4>     FROM PowerDemand_Tab P
    5>     WHERE Power_GreaterThanAny(P.Sample,50) = 1;
Statement processed.
SQLPLUS> @tkoqxpl1
SQLPLUS> set echo off
Echo                                OFF
Charwidth                            15
OPERATIONS      OPTIONS      OBJECT_NAME
-----
SELECT STATEMEN
TABLE ACCESS    BY ROWID      POWERDEMAND_TAB
DOMAIN INDEX    POWERINDEX
3 rows selected.
Statement processed.
Echo                                ON
SQLPLUS>
SQLPLUS> SELECT P.Region, P.Sample.TotGridDemand ,P.Sample.MaxCellDemand,
    2>     P.Sample.MinCellDemand
    3>     FROM PowerDemand_Tab P
    4>     WHERE Power_GreaterThanAny(P.Sample,50) = 1;
REGION      SAMPLE.TOT  SAMPLE.MAX  SAMPLE.MIN
-----
          1          90          55          5
          1          89          56          3
          1          88          55          3
          1          87          54          3
          1          86          54          3
5 rows selected.
ODCIIndexStart>>>>
ODCIIndexInfo
Index owner : POWERCARTUSER
Index name : POWERINDEX
Table owner : POWERCARTUSER
Table name : POWERDEMAND_TAB
Indexed column : "SAMPLE"
Indexed column type :POWERDEMAND_TYP
Indexed column type schema:POWERCARTUSER
ODCIPredInfo

```

```
Object owner : POWERCARTUSER
Object name : POWER_GREATERTHANANY
Method name :
Predicate bounds flag :
    Exact Match
    Include Start Key
    Include Stop Key
start key : 1
stop key : 1
compare value : 50
ODCIIndexStart>>>>select distinct r from POWERCARTUSER.POWERINDEX_pidx where cv
al >'50'
ODCIIndexFetch>>>>
Nrows : 2000
ODCIIndexClose>>>>
SQLPLUS>
SQLPLUS> explain plan for
  2> SELECT P.Region, P.Sample.TotGridDemand ,P.Sample.MaxCellDemand,
  3>     P.Sample.MinCellDemand
  4>     FROM PowerDemand_Tab P
  5>     WHERE Power_LessThanAny(P.Sample,50) = 0;
Statement processed.
SQLPLUS> @tkoqxpl1
SQLPLUS> set echo off
Echo                                OFF
Charwidth                            15
OPERATIONS      OPTIONS      OBJECT_NAME
-----
SELECT STATEMEN
TABLE ACCESS     BY ROWID      POWERDEMAND_TAB
DOMAIN INDEX    POWERINDEX
3 rows selected.
Statement processed.
Echo                                ON
SQLPLUS>
SQLPLUS> SELECT P.Region, P.Sample.TotGridDemand ,P.Sample.MaxCellDemand,
  2>     P.Sample.MinCellDemand
  3>     FROM PowerDemand_Tab P
  4>     WHERE Power_LessThanAny(P.Sample,50) = 0;
REGION      SAMPLE.TOT  SAMPLE.MAX  SAMPLE.MIN
-----
0 rows selected.
ODCIIndexStart>>>>
ODCIIndexInfo
Index owner : POWERCARTUSER
Index name : POWERINDEX
Table owner : POWERCARTUSER
Table name : POWERDEMAND_TAB
Indexed column : "SAMPLE"
Indexed column type :POWERDEMAND_TYP
Indexed column type schema:POWERCARTUSER
ODCIPredInfo
Object owner : POWERCARTUSER
Object name : POWER_LESSTHANANY
Method name :
Predicate bounds flag :
    Exact Match
    Include Start Key
    Include Stop Key
start key : 0
stop key : 0
```



```
compare value : 50
ODCIIndexStart>>>>select distinct r from POWERCARTUSER.POWERINDEX_pidx minus se
lect distinct r from POWERCARTUSER.POWERINDEX_pidx where cval <'50'
ODCIIndexFetch>>>>
Nrows : 2000
ODCIIndexClose>>>>
```

# 16

## PSBTREE: Extensible Indexing Example

This is an example of extensible indexing, with C-language implementation of `ODCIIndex` interface routines.

### 16.1 About the PSBTREE Example

Consider how to implement the extensible indexing interface routines in C. The example's focus is on topics that are common to all implementations; it does not expose domain-specific details.

The code for the example is in the `demo` directory, in the file `extdemo6.sql`. It extends an earlier example (`extdemo2.sql`, also in `demo` directory) by adding to the `indextype` support for local domain indexes on range partitioned tables.

### 16.2 Design of the Indextype

The `indextype` implemented here, called `PSBtree`, operates like a b-tree index. It supports three user-defined operators: `eq` (equals), `lt` (less than), and `gt` (greater than). These operators operate on operands of `VARCHAR2` data type.

The index data consists of records of the form `<key, rid>` where `key` is the value of the indexed column and `rid` is the row identifier of the corresponding row. To simplify the implementation of the `indextype`, the index data is stored in a system-partitioned table.

When an index is a system-managed local domain index, one partition in a system-partitioned table is created for each partition to store the index data for that partition. Thus, the index manipulation routines merely translate operations on the `PSBtree` into operations on the table partition that stores the index data.

When a user creates a `PSBtree` index (a local index), `n` table partitions are created consisting of the indexed column and a `rowid` column, where `n` is the number of partitions in the base table. Inserts into the base table cause appropriate insertions into the affected index table partition. Deletes and updates are handled similarly. When the `PSBtree` is queried based on a user-defined operator (one of `gt`, `lt` and `eq`), an appropriate query is issued against the index table partitions to retrieve all the satisfying rows. Appropriate partition pruning occurs, and only the index table partitions that correspond to the relevant, or "interesting", partitions are accessed.

### 16.3 Implementing Operators

The `PSBtree` `indextype` supports three operators: `eq`, `gt` and `lt`. Each operator has a corresponding functional implementation.

## 16.3.1 Functional Implementations

Consider the functional implementation of comparison operators. The [Implementing the EQUALS Operator](#) section explains how to implement `eq` (equals), the [Implementing the LESS THAN Operator](#) section explains how to implement `lt` (less than), and the [Implementing the GREATER THAN Operator](#) section explains how to implement `gt` (greater than) operators.

### 16.3.1.1 Implementing the EQUALS Operator

The functional implementation for `eq` is provided by a function (`bt_eq`) that takes in two `VARCHAR2` parameters and returns 1 if they are equal and 0 otherwise.

```
CREATE FUNCTION bt_eq(a VARCHAR2, b VARCHAR2) RETURN NUMBER AS
BEGIN
  IF a = b then
    RETURN 1;
  ELSE
    RETURN 0;
  END IF;
END;
```

### 16.3.1.2 Implementing the LESS THAN Operator

The functional implementation for `lt` is provided by a function (`bt_lt`) that takes in two `VARCHAR2` parameters and returns 1 if the first parameter is less than the second, 0 otherwise.

```
CREATE FUNCTION bt_lt(a VARCHAR2, b VARCHAR2) RETURN NUMBER AS
BEGIN
  IF a < b then
    RETURN 1;
  ELSE
    RETURN 0;
  END IF;
END;
```

### 16.3.1.3 Implementing the GREATER THAN Operator

The functional implementation for `gt` is provided by a function (`bt_gt`) that takes in two `VARCHAR2` parameters and returns 1 if the first parameter is greater than the second, 0 otherwise.

```
CREATE FUNCTION bt_gt(a VARCHAR2, b VARCHAR2) RETURN NUMBER AS
BEGIN
  IF a > b then
    RETURN 1;
  ELSE
    RETURN 0;
  END IF;
END;
```

## 16.3.2 Operators

To create the operator, you must specify the signature of the operator along with its return type and its functional implementation. [Example 16-1](#) shows how to create `eq`

(equals), [Example 16-2](#) shows how to create `lt` (less than), and [Example 16-3](#) shows how to create `gt` (greater than) operators.

#### Example 16-1 Creating the EQUALS Operator

```
CREATE OPERATOR eq
BINDING (VARCHAR2, VARCHAR2) RETURN NUMBER
USING bt_eq;
```

#### Example 16-2 Creating the LESS THAN Operator

```
CREATE OPERATOR lt
BINDING (VARCHAR2, VARCHAR2) RETURN NUMBER
USING bt_lt;
```

#### Example 16-3 Creating the GREATER THAN Operator

```
CREATE OPERATOR gt
BINDING (VARCHAR2, VARCHAR2) RETURN NUMBER
USING bt_gt;
```

## 16.4 Implementing the ODCIIndex Interfaces

To implement the `PSBTREE`, you must implement the `ODCIIndexXXX()` routines. You can implement the index routines in any language supported by Oracle. This discussion implements the [ODCIGetInterfaces\(\)](#) routine in the C programming language. Note that these require advance setup, such as creating a library object, `extdemo61`, for your compiled C code.

### 16.4.1 Defining an Implementation Type for PSBTREE

Define an implementation type that implements the `ODCIIndex` interface routines, as demonstrated in [Example 16-4](#).

#### Example 16-4 Creating a PSBTREE Index Type

```
CREATE TYPE psbtree_im AUTHID CURRENT_USER AS OBJECT
(
  scanctx RAW(4),
  STATIC FUNCTION ODCIGetInterfaces(ifclist OUT SYS.ODCIObjectList)
    RETURN NUMBER,
  STATIC FUNCTION ODCIIndexCreate (ia SYS.ODCIIndexInfo, parms VARCHAR2,
    env SYS.ODCIEnv) RETURN NUMBER,
  STATIC FUNCTION ODCIIndexAlter (ia sys.ODCIIndexInfo,
    parms IN OUT VARCHAR2, altopt number, env sys.ODCIEnv) RETURN NUMBER,
  STATIC FUNCTION ODCIIndexDrop(ia SYS.ODCIIndexInfo, env SYS.ODCIEnv)
    RETURN NUMBER,
  STATIC FUNCTION ODCIIndexExchangePartition(ia SYS.ODCIIndexInfo,
    ial SYS.ODCIIndexInfo, env SYS.ODCIEnv) RETURN NUMBER,
  STATIC FUNCTION ODCIIndexUpdPartMetadata(ia sys.ODCIIndexInfo,
    palist sys.ODCIPartInfoList, env sys.ODCIEnv) RETURN NUMBER,
  STATIC FUNCTION ODCIIndexInsert(ia SYS.ODCIIndexInfo, rid VARCHAR2,
    newval VARCHAR2, env SYS.ODCIEnv) RETURN NUMBER,
  STATIC FUNCTION ODCIIndexDelete(ia SYS.ODCIIndexInfo, rid VARCHAR2,
    oldval VARCHAR2, env SYS.ODCIEnv) RETURN NUMBER,
  STATIC FUNCTION ODCIIndexUpdate(ia SYS.ODCIIndexInfo, rid VARCHAR2,
    oldval VARCHAR2, newval VARCHAR2, env SYS.ODCIEnv) RETURN NUMBER,
  STATIC FUNCTION ODCIIndexStart(sctx IN OUT psbtree_im, ia SYS.ODCIIndexInfo,
    op SYS.ODCIPredInfo, qi sys.ODCIQueryInfo, strt number, stop number,
```

```

        cmpval VARCHAR2, env SYS.ODCIEnv) RETURN NUMBER,
MEMBER FUNCTION ODCIIndexFetch(nrows NUMBER, rids OUT SYS.ODCIridlist,
env SYS.ODCIEnv) RETURN NUMBER,
MEMBER FUNCTION ODCIIndexClose(env SYS.ODCIEnv) RETURN NUMBER
);
/
SHOW ERRORS

```

## 16.4.2 Creating the Implementation Type Body

Define the implementation type body, as demonstrated in [Example 16-5](#).

### Example 16-5 Creating the Implementation Body for PBSTREE

```
CREATE OR REPLACE TYPE BODY psbtree_im IS
```

## 16.4.3 Defining PL/SQL Routines in the Implementation Body

Consider how to implement the index definition routines in PL/SQL.

### 16.4.3.1 Implementing ODCIGetInterfaces() for PBSTREE in PL/SQL

The [ODCIGetInterfaces\(\)](#) routine returns the expected interface name through its `OUT` parameter.

```

STATIC FUNCTION ODCIGetInterfaces(
    ifclist OUT sys.ODCIObjectList)
RETURN NUMBER IS
BEGIN
    ifclist := sys.ODCIObjectList(sys.ODCIObject('SYS','ODCIINDEX2'));
    RETURN ODCIConst.Success;
END ODCIGetInterfaces;

```

### 16.4.3.2 Implementing ODCIIndexCreate() for PBSTREE in PL/SQL

The [ODCIIndexCreate\(\)](#) routine creates a system-partitioned index storage table with two columns. The first column stores the `VARCHAR2` indexed column value. The routine makes use of the information passed in to determine the context in which it is invoked. Dynamic SQL is used to execute the dynamically constructed SQL statement.

```

STATIC FUNCTION ODCIIndexCreate (
    ias sys.ODCIIndexInfo,
    parms VARCHAR2,
    env sys.ODCIEnv)
RETURN NUMBER IS
    i INTEGER;
    stmt VARCHAR2(2000);
    cursor curl(ianame VARCHAR2) IS
        SELECT partition_name, parameters
        FROM user_ind_partitions
        WHERE index_name = ianame
        ORDER BY partition_position;
    cursor cur2(ianame VARCHAR2) IS
        SELECT subpartition_name, parameters
        FROM user_ind_subpartitions
        WHERE index_name = ianame
        ORDER BY partition_position, subpartition_position;
BEGIN

```

```

stmt := '';

IF (env.CallProperty is null) THEN
  stmt := 'create table ' || ia.IndexSchema || '.' || ia.IndexName ||
    '_sbtrees(f1 VARCHAR2(1000), f2 rowid)';

ELSIF (env.CallProperty = sys.ODCIConst.FirstCall) THEN
  stmt := '';
  i := 1;

  IF (bitand(ia.IndexInfoFlags, ODCIConst.CompPartn) = 0) THEN
    FOR c1 in curl(ia.IndexName) LOOP
      IF (i > 1) THEN
        stmt := stmt || ',';
      END IF;
      stmt := stmt || 'partition ' || c2.partition_name;
      i := i + 1;
    END LOOP;
  ELSE
    FOR c1 in curl(ia.IndexName) LOOP
      IF (i > 1) THEN
        stmt := stmt || ',';
      END IF;
      stmt := stmt || 'partition ' || c2.subpartition_name;
      i := i + 1;
    END LOOP;
  END IF;
  stmt := 'create table ' || ia.IndexSchema || '.' || ia.IndexName ||
    '_sbtrees (f1 VARCHAR2(1000), f2 rowid) partition by system ' ||
    '(' || stmt || ')';

ELSIF (env.CallProperty = sys.ODCIConst.FinalCall) THEN
  stmt := 'create index ' || ia.IndexSchema || '.' || ia.IndexName ||
    '_sbtrees on ' || ia.IndexSchema || '.' || ia.IndexName ||
    '_sbtrees (f1) local';
END IF;

dbms_output.put_line('Create');
dbms_output.put_line(stmt);

-- execute the statement
IF ((env.CallProperty is null) OR
    (env.CallProperty = sys.ODCIConst.FirstCall) OR
    (env.CallProperty = sys.ODCIConst.FinalCall) ) THEN
  execute immediate stmt;

  IF (env.CallProperty is null) THEN
    execute immediate 'insert into ' || ia.IndexSchema || '.' || ia.IndexName
      || '_sbtrees select ' || ia.IndexCols(1).ColName || ', ROWID from ' ||
      ia.IndexCols(1).TableSchema || '.' || ia.IndexCols(1).TableName;
    execute immediate 'create index ' || ia.IndexSchema || '.' ||
      ia.IndexName || '_sbtrees on ' || ia.IndexSchema || '.' ||
      ia.IndexName || '_sbtrees (f1)';
  END IF;
END IF;

RETURN ODCIConst.Success;
END ODCIIndexCreate;

```

### 16.4.3.3 Implementing ODCIIndexDrop() for PBSTREE in PL/SQL

The `ODCIIndexDrop()` routine drops the index storage tables.

```

STATIC FUNCTION ODCIIndexDrop(
  ia sys.ODCIIndexInfo,
  env sys.ODCIEnv)
RETURN NUMBER IS
  stmt VARCHAR2(1000);
  cnum INTEGER;
  junk INTEGER;
BEGIN
  -- construct the sql statement
  stmt := '';

  IF (env.CallProperty is null) THEN
    stmt := 'drop table ' || ia.IndexSchema || '.' || ia.IndexName || '_sbtrees';
    dbms_output.put_line('Drop');
    dbms_output.put_line(stmt);
    execute immediate stmt;
  END IF;
  RETURN ODCIConst.Success;
END ODCIIndexDrop;

```

### 16.4.3.4 Implementing ODCIIndexAlter() for PSBTREE in PL/SQL

The `ODCIIndexAlter()` routine can perform many index alteration tasks, such as rebuilding and renaming an index.

```

STATIC FUNCTION ODCIIndexAlter (
  ia sys.ODCIIndexInfo,
  parms IN OUT VARCHAR2,
  altop NUMBER,
  env sys.ODCIEnv)
RETURN NUMBER IS
  stmt VARCHAR2(2000);
BEGIN
  stmt := '';
  IF (altop = ODCIConst.AlterIndexRebuild) THEN
    IF (ia.IndexPartition is null) THEN
      stmt := 'insert into ' || ia.IndexSchema || '.' || ia.IndexName ||
        '_sbtrees select ' || ia.IndexCols(1).ColName || ', ROWID from ' ||
        ia.IndexCols(1).ColName || ', ROWID from ' ||
        ia.IndexCols(1).TableSchema || '.' || ia.IndexCols(1).TableName;
    ELSIF (bitand(ia.IndexInfoFlags, ODCIConst.CompPartn) = 0) THEN
      stmt := 'insert into ' || ia.IndexSchema || '.' || ia.IndexName ||
        '_sbtrees select partition (' || ia.IndexPartition || ') ' ||
        ia.IndexCols(1).ColName || ', ROWID from ' ||
        ia.IndexCols(1).TableSchema || '.' || ia.IndexCols(1).TableName ||
        ' partition (' || ia.IndexCols(1).TablePartition || ')';
    ELSE
      stmt := 'insert into ' || ia.IndexSchema || '.' || ia.IndexName ||
        '_sbtrees select partition (' || ia.IndexPartition || ') ' ||
        ia.IndexCols(1).ColName || ', ROWID from ' ||
        ia.IndexCols(1).TableSchema || '.' || ia.IndexCols(1).TableName ||
        ' subpartition (' || ia.IndexCols(1).TablePartition || ')';
    END IF;
  ELSIF (altop = ODCIConst.AlterIndexRename) THEN

```

```

IF (ia.IndexPartition is not null) THEN
    stmt := 'alter table ' || ia.IndexSchema || '.' || ia.IndexName ||
        '_sbtrees rename partition ' || ia.IndexPartition || ' to ' || parms;
ELSE
    stmt := 'alter table ' || ia.IndexSchema || '.' || ia.IndexName ||
        '_sbtrees rename to ' || parms || '_sbtrees';
END IF;
END IF;

dbms_output.put_line('Alter');
IF ((altopt = ODCIConst.AlterIndexRebuild) OR (altopt =
ODCIConst.AlterIndexRename))
THEN
    dbms_output.put_line(stmt);
    execute immediate stmt;
END IF;
RETURN ODCIConst.Success;
END ODCIIndexAlter;

```

### 16.4.3.5 Implementing ODCIIndexUpdPartMetadata() for PSBTREE in PL/SQL

To handle partition maintenance operations, the kernel performs the maintenance tasks on behalf of the user. The `indextype`, to maintain its metadata, should have the [ODCIIndexUpdPartMetadata\(\)](#) routine.

```

STATIC FUNCTION ODCIIndexUpdPartMetadata(
    ia sys.ODCIIndexInfo,
    palist sys.ODCIPartInfoList,
    env sys.ODCIEnv)
RETURN NUMBER IS
    col number;
BEGIN
    dbms_output.put_line('ODCIUpdPartMetadata');
    sys.ODCIIndexInfoDump(ia);
    sys.ODCIPartInfoListDump(palist);
    sys.ODCIEnvDump(env);
    RETURN ODCIConst.Success;
END ODCIIndexUpdPartMetadata;

```

### 16.4.3.6 Implementing ODCIIndexExchangePartition() for PSBTREE in PL/SQL

The [ODCIIndexExchangePartition\(\)](#) exchanges the index storage tables for the index partition being exchanged, with the index storage table for the global domain index.

```

STATIC FUNCTION ODCIIndexExchangePartition(
    ia sys.ODCIIndexInfo,
    ial sys.ODCIIndexInfo,
    env sys.ODCIEnv)
RETURN NUMBER IS
    stmt VARCHAR2(2000);
    cnum INTEGER;
    junk INTEGER;
BEGIN
    stmt := '';
    dbms_output.put_line('Exchange Partition');

    -- construct the sql statements
    IF bitand(ia.IndexInfoFlags, ODCIConst.CompPartn) = 0 OR
        bitand(ia.IndexInfoFlags, ODCIConst.SubPartn) = ODCIConst.SubPartn THEN
        -- non-composite partitioned or exchanging subpartition

```



```

stmt := 'alter table ' || ia.IndexSchema || '.' || ia.IndexName ||
'_sbtrees exchange partition ' || ia.IndexPartition || ' with table ' ||
ial.IndexSchema || '.' || ial.IndexName || '_sbtrees';

dbms_output.put_line(stmt);
execute immediate stmt;
ELSE
-- composite partition exchange
stmt := 'create table temp_exch (f1 VARCHAR2(1000), f2 rowid)';
dbms_output.put_line(stmt);
execute immediate stmt;

stmt := 'alter table ' || ia.IndexSchema || '.' || ia.IndexName ||
'_sbtrees exchange partition ' || ia.IndexPartition || ' with table ' ||
'temp_exch';
dbms_output.put_line(stmt);
execute immediate stmt;

stmt := 'alter table ' || ial.IndexSchema || '.' || ial.IndexName ||
'_sbtrees exchange partition ' || ial.IndexPartition || ' with table ' ||
'temp_exch';
dbms_output.put_line(stmt);
execute immediate stmt;

stmt := 'alter table ' || ia.IndexSchema || '.' || ia.IndexName ||
'_sbtrees exchange partition ' || ia.IndexPartition || ' with table ' ||
'temp_exch';
dbms_output.put_line(stmt);
execute immediate stmt;

-- exchange done, drop temporal table
stmt := 'drop table temp_exch';
dbms_output.put_line(stmt);
execute immediate stmt;
END IF;

RETURN ODCIConst.Success;
END ODCIIndexExchangePartition;

```

## 16.4.4 Registering the C Implementation of the ODCIIndexXXX() Methods

After creating the `extdemo61` library object for the compiled C methods, you must register the implementations of each of the routines. The [Registering the Implementation of ODCIIndexInsert\(\)](#) section demonstrates how to register the ODCIIndexInsert() implementation, the [Registering the Implementation of ODCIIndexDelete\(\)](#) section registers the ODCIIndexDelete() implementation, the [Registering the Implementation of ODCIIndexUpdate\(\)](#) section registers the ODCIIndexUpdate() implementation, the [Registering the Implementation of ODCIIndexStart\(\)](#) section registers the ODCIIndexStart() implementation, the [Registering the Implementation of ODCIIndexFetch\(\)](#) section registers the ODCIIndexFetch() implementation, and the [Registering the Implementation of ODCIIndexClose\(\)](#) section registers the ODCIIndexClose() implementation.

### 16.4.4.1 Registering the Implementation of ODCIIndexInsert()

Register the implementation of the [ODCIIndexInsert\(\)](#) routine.

```
STATIC FUNCTION ODCIIndexInsert(  
    ia SYS.ODCIIndexInfo,  
    rid VARCHAR2,  
    newval VARCHAR2,  
    env SYS.ODCIEnv)  
RETURN NUMBER AS EXTERNAL  
name "qxigtbspi"  
library extdemo61  
with context  
parameters (  
    context,  
    ia,  
    ia indicator struct,  
    rid,  
    rid indicator,  
    newval,  
    newval indicator,  
    env,  
    env indicator struct,  
    return OCINumber  
);
```

#### 16.4.4.2 Registering the Implementation of ODCIIndexDelete()

Register the implementation of the [ODCIIndexDelete\(\)](#) routine.

```
STATIC FUNCTION ODCIIndexDelete(  
    ia SYS.ODCIIndexInfo,  
    rid VARCHAR2,  
    oldval VARCHAR2,  
    env SYS.ODCIEnv)  
RETURN NUMBER AS EXTERNAL  
name "qxigtbspd"  
library extdemo61  
with context  
parameters (  
    context,  
    ia,  
    ia indicator struct,  
    rid,  
    rid indicator,  
    oldval,  
    oldval indicator,  
    env,  
    env indicator struct,  
    return OCINumber  
);
```

#### 16.4.4.3 Registering the Implementation of ODCIIndexUpdate()

Register the implementation of the [ODCIIndexUpdate\(\)](#) routine.

```
STATIC FUNCTION ODCIIndexUpdate(  
    ia SYS.ODCIIndexInfo,  
    rid VARCHAR2,  
    oldval VARCHAR2,  
    newval VARCHAR2,  
    env SYS.ODCIEnv)  
RETURN NUMBER AS EXTERNAL  
name "qxigtbspu"
```

```
library extdemo01
with context
parameters (
  context,
  ia,
  ia indicator struct,
  rid,
  rid indicator,
  oldval,
  oldval indicator,
  newval,
  newval indicator,
  env,
  env indicator struct,
  return OCINumber
);
```

#### 16.4.4.4 Registering the Implementation of ODCIIndexStart()

Register the implementation of the [ODCIIndexStart\(\)](#) routine.

```
STATIC FUNCTION ODCIIndexStart(
  sctx IN OUT psbtree_im,
  ia SYS.ODCIIndexInfo,
  op SYS.ODCIPredInfo,
  qi SYS.ODCIQueryInfo,
  strt NUMBER,
  stop NUMBER,
  cmpval VARCHAR2,
  env SYS.ODCIEnv)
RETURN NUMBER AS EXTERNAL
name "qxigtbsps"
library extdemo01
with context
parameters (
  context,
  sctx,
  sctx indicator struct,
  ia,
  ia indicator struct,
  op,
  op indicator struct,
  qi,
  qi indicator struct,
  strt,
  strt indicator,
  stop,
  stop indicator,
  cmpval,
  cmpval indicator,
  env,
  env indicator struct,
  return OCINumber
);
```

#### 16.4.4.5 Registering the Implementation of ODCIIndexFetch()

Register the implementation of the [ODCIIndexFetch\(\)](#) routine.

```

MEMBER FUNCTION ODCIIndexFetch(
    nrows NUMBER,
    rids OUT SYS.ODCIRidList,
    env SYS.ODCIEnv)
RETURN NUMBER AS EXTERNAL
name "qxigtbspf"
library extdemo61
with context
parameters (
    context,
    self,
    self indicator struct,
    nrows,
    nrows indicator,
    rids,
    rids indicator,
    env,
    env indicator struct,
    return OCINumber
);

```

#### 16.4.4.6 Registering the Implementation of ODCIIndexClose()

Register the implementation of the [ODCIIndexClose\(\)](#) routine.

```

MEMBER FUNCTION ODCIIndexClose (
    env SYS.ODCIEnv)
RETURN NUMBER AS EXTERNAL
name "qxigtbspc"
library extdemo61
with context
parameters (
    context,
    self,
    self indicator struct,
    env,
    env indicator struct,
    return OCINumber
);

```

#### 16.4.5 Defining Additional Structures in C Implementation

The struct `qxigtim`, struct `qciqtin`, and struct `qxigtex` are used for mapping the object type and its null value (demonstrated in [Example 16-6](#)), and for keeping state during fetching calls (demonstrated in [Example 16-7](#)). These structures are used by the methods described in [Defining C Methods in the Implementation Body](#).

The C structs for mapping the ODCI types are defined in the file `odci.h`. For example, the C struct `ODCIIndexInfo` is the mapping for the corresponding ODCI object type. The C struct `ODCIIndexInfo_ind` is the mapping for the null object.

##### **Example 16-6** Defining Mappings for the Object Type and Its Null Value

We have defined a C struct, `qxigtim`, as a mapping for the object type. There is an additional C struct, `qciqtin`, for the corresponding null object. The C structs for the object type and its null object can be generated from the Object Type Translator (OTT).

```

/* The index implementation type is an object type with a single RAW attribute
 * used to store the context key value.

```

```

* C mapping of the implementation type : */

struct qxiqtim{
    OCIRaw *sctx_qxiqtim;
};
typedef struct qxiqtim qxiqtim;

struct qxiqtin{
    short atomic_qxiqtin;
    short scind_qxiqtin;
};
typedef struct qxiqtin qxiqtin;

```

### Example 16-7 Keeping the Scan State During Fetching Calls

There are a set of OCI handles that must be cached away and retrieved during fetch calls. A C struct, `qxiqtctx`, is defined to hold all the necessary scan state. This structure is allocated out of `OCI_DURATION_STATEMENT` memory to ensure that it persists till the end of `fetch`. After populating the structure with the required info, a pointer to the structure is saved in OCI context. The context is identified by a 4-byte key that is generated by calling an OCI routine. The 4-byte key is stashed away in the scan context - `exiting`. This object is returned back to the Oracle server and is passed in as a parameter to the next fetch call.

```

/* The index scan context - should be stored in "statement" duration memory
* and used by start, fetch and close routines.
*/
struct qxiqtctx
{
    OCISmt *stmthp;
    OCIDefine *defnp;
    OCIBind *bndp;
    char ridp[19];
};
typedef struct qxiqtctx qxiqtctx;

```

## 16.4.6 Defining C Methods in the Implementation Body

Consider how to implemented PSBEETree methods in the C language.

### 16.4.6.1 Implementing a Common Error Processing Routine in C

This function is used to check and process the return code from all OCI routines. It checks the status code and raises an exception in case of errors.

```

static int qxiqtce(
    OCIExtProcContext *ctx,
    OCIError *errhp,
    sword status)
{
    text errbuf[512];
    sb4 errcode = 0;
    int errnum = 29400; /* choose some oracle error number */
    int rc = 0;

    switch (status)
    {
        case OCI_SUCCESS:
            rc = 0;

```

```

        break;
    case OCI_ERROR:
        (void) OCIErrorGet((dvoid *)errhp, (ub4)1, (text *)NULL, &errcode,
            errbuf, (ub4)sizeof(errbuf), OCI_HTYPE_ERROR);
        /* Raise exception */
        OCIExtProcRaiseExcpWithMsg(ctx, errnum, errbuf, strlen((char *)errbuf));
        rc = 1;
        break;
    default:
        (void) sprintf((char *)errbuf, "Warning - some error\n");
        /* Raise exception */
        OCIExtProcRaiseExcpWithMsg(ctx, errnum, errbuf, strlen((char *)errbuf));
        rc = 1;
        break;
    }
    return (rc);
}

```

### 16.4.6.2 Implementing ODCIIndexInsert() for PSBTREE in C

The insert routine, `ODCIIndexInsert()`, parses and executes a statement that inserts a new row into the index table. The new row consists of the new value of the indexed column and the `rowid` that have been passed in as parameters.

```

OCINumber *qxigtbspi(
    OCIExtProcContext *ctx,
    ODCIIndexInfo *ix,
    ODCIIndexInfo_ind *ix_ind,
    char *rid,
    short rid_ind,
    char *newval,
    short newval_ind,
    OCIEnv *env,
    OCIEnv_ind *env_ind)
{
    OCIEnv *envhp = (OCIEnv *) 0; /* env. handle */
    OCISvcCtx *svchp = (OCISvcCtx *) 0; /* service handle */
    OCIError *errhp = (OCIError *) 0; /* error handle */
    OCISmt *stmthp = (OCISmt *) 0; /* statement handle */
    OCIBind *bndp = (OCIBind *) 0; /* bind handle */

    int retval = (int)ODCI_SUCCESS; /* return from this function */
    OCINumber *rval = (OCINumber *)0;

    char insstmt[2000]; /* sql insert statement */
    ODCIColInfo *colinfo; /* column info */
    ODCIColInfo_ind *colinfo_ind;
    boolean exists = TRUE;
    unsigned int partiden; /* table partition iden */
    unsigned int idxflag; /* index info flag

    /* allocate memory for OCINumber first */
    rval = (OCINumber *)OCIExtProcAllocCallMemory(ctx, sizeof(OCINumber));

    /* Get oci handles */
    if (qxigtce(ctx, errhp, OCIExtProcGetEnv(ctx, &envhp, &svchp, &errhp)))
        return(rval);

    /* set up return code */
    if (qxigtce(ctx, errhp, OCINumberFromInt(errhp, (dvoid *)&retval,

```

```

        sizeof(retval), OCI_NUMBER_SIGNED, rval)))
    return(retval);

/* Convert idxflag to integer from OCINumber */
if (qxigtce(ctx, errhp, OCINumberToInt(errhp, &(ix->IndexInfoFlags),
    sizeof(idxflag), OCI_NUMBER_UNSIGNED, ( void *)&idxflag)))
    return(retval);

/*****
 * Construct insert Statement *
 *****/
if ((idxflag & ODCI_INDEX_RANGE_PARTN) != ODCI_INDEX_RANGE_PARTN)
    (void)sprintf(insstmt, "INSERT into %s.%s_sbtrees values (:newval, :mrid)",
        OCIStringPtr(envhp, ix->IndexSchema), OCIStringPtr(envhp, ix->IndexName));
else
{
    if (qxigtce(ctx, errhp, OCICollGetElem(envhp, errhp, (OCIColl *)ix->IndexCols,
        (sb4)0, &exists, (void **) &colinfo, (void **) &colinfo_ind)))
        return(retval);

    (void)sprintf(insstmt,
        "INSERT into %s.%s_sbtrees partition (DATAOBJ_TO_PARTITION(%s, :partiden))
        VALUES (:newval, :mrid)",
        OCIStringPtr(envhp, ix->IndexSchema), OCIStringPtr(envhp, ix->IndexName),
        OCIStringPtr(envhp, colinfo->TableName));
}

/*****
 * Parse and Execute Create Statement *
 *****/

/* allocate stmt handle */
if (qxigtce(ctx, errhp, OCIHandleAlloc((dvoid *)envhp, (dvoid **)&stmthp,
    (ub4)OCI_HTYPE_STMT, (size_t)0, (dvoid **)0)))
    return(retval);

/* prepare the statement */
if (qxigtce(ctx, errhp, OCIStmtPrepare(stmthp, errhp, (text *)insstmt,
    (ub4)strlen(insstmt), OCI_NTV_SYNTAX, OCI_DEFAULT)))
    return(retval);

if ((idxflag & ODCI_INDEX_RANGE_PARTN) == ODCI_INDEX_RANGE_PARTN)
{
    /* Convert partiden to integer from OCINumber */
    if (qxigtce(ctx, errhp, OCINumberToInt(errhp,
        &(colinfo->TablePartitionIden), sizeof(partiden), OCI_NUMBER_UNSIGNED,
        ( void *)&partiden)))
        return(retval);

    /* Set up bind for partiden */
    if (qxigtce(ctx, errhp, OCIBindByName(stmthp, &bndp, errhp,
        text *):partiden", sizeof(":partiden")-1, (dvoid *)&partiden,
        (sb4)(sizeof(partiden)), (ub2)SQLT_INT, (dvoid *)0, (ub2 *)0,
        (ub2 *)0, (ub4)0, (ub4 *)0, (ub4)OCI_DEFAULT)))
        return(retval);
}

/* Set up bind for newval */
if (qxigtce(ctx, errhp, OCIBindByName(stmthp, &bndp, errhp, (text *)":newval",
    sizeof(":newval")-1, (dvoid *)newval, (sb4)(strlen(newval)+1),
    (ub2)SQLT_STR, (dvoid *)0, (ub2 *)0, (ub2 *)0, (ub4)0, (ub4 *)0,

```

```

        (ub4)OCI_DEFAULT)))
    return(rval);

    /* Set up bind for rid */
    if (qxiqtce(ctx, errhp, OCIBindByName(stmtHP, &bndp, errhp, (text *)":mrid",
        sizeof(":mrid")-1, (dvoid *)rid, (sb4)(strlen(rid)+1), (ub2)SQL_STR,
        (dvoid *)0, (ub2 *)0, (ub2 *)0, (ub4)0, (ub4 *)0, (ub4)OCI_DEFAULT)))
        return(rval);

    /* Execute statement */
    if (qxiqtce(ctx, errhp, OCISmtExecute(svchp, stmtHP, errhp, (ub4)1,
        (ub4)0, (OCISnapshot *)NULL, (OCISnapshot *)NULL, (ub4)OCI_DEFAULT)))
        return(rval);

    /* free stmt handle */
    if (qxiqtce(ctx, errhp, OCIHandleFree((dvoid *)stmtHP, (ub4)OCI_HTYPE_STMT)))
        return(rval);

    return(rval);
}

```

### 16.4.6.3 Implementing ODCIIndexDelete() for PSBTREE in C

The delete routine constructs a SQL statement to delete a row from the index table corresponding to the row being deleted from the base table. The row in the index table is identified by the value of `rowid` that is passed in as a parameter to this routine.

```

OCINumber *qxiqtbspd(
    OCIExtProcContext *ctx,
    ODCIIndexInfo *ix,
    ODCIIndexInfo_ind *ix_ind,
    char *rid,
    short rid_ind,
    char *oldval,
    short oldval_ind,
    ODCIEnv *env,
    ODCIEnv_ind *env_ind)
{
    OCIEnv *envhp = (OCIEnv *) 0; /* env. handle */
    OCISvcCtx *svchp = (OCISvcCtx *) 0; /* service handle */
    OCIError *errhp = (OCIError *) 0; /* error handle */
    OCISmt *stmtHP = (OCISmt *) 0; /* statement handle */
    OCIBind *bndp = (OCIBind *) 0; /* bind handle */

    int retval = (int)ODCI_SUCCESS; /* return from this function */
    OCINumber *rval = (OCINumber *)0;

    char delstmt[2000]; /* sql delete statement */
    ODCIColInfo *colinfo; /* column info */
    ODCIColInfo_ind *colinfo_ind;
    boolean exists = TRUE;
    unsigned int partiden; /* table partition iden */
    unsigned int idxflag; /* index info flag

    /* Get oci handles */
    if (qxiqtce(ctx, errhp, OCIExtProcGetEnv(ctx, &envhp, &svchp, &errhp)))
        return(rval);

    /* set up return code */
    rval = (OCINumber *)OCIExtProcAllocCallMemory(ctx, sizeof(OCINumber));

```



```

if (qxigtce(ctx, errhp, OCINumberFromInt(errhp, (dvoid *)&retval,
    sizeof(retval), OCI_NUMBER_SIGNED, rval)))
    return(rval);

/* Convert idxflag to integer from OCINumber */
if (qxigtce(ctx, errhp, OCINumberToInt(errhp, &(ix->IndexInfoFlags),
    sizeof(idxflag), OCI_NUMBER_UNSIGNED, ( void *)&idxflag)))
    return(rval);

/*****
* Construct delete Statement *
*****/
if ((idxflag & ODCI_INDEX_RANGE_PARTN) != ODCI_INDEX_RANGE_PARTN)
    (void)sprintf(delstmt, "DELETE FROM %s.%s_sbtree WHERE f2 = :rr",
        OCIStrngPtr(envhvp, ix->IndexSchema), OCIStrngPtr(envhvp, ix->IndexName));
else
{
    if (qxigtce(ctx, errhp, OCICollGetElem(envhvp, errhp, (OCIColl *)ix->IndexCols,
        (sb4)0, &exists, (void **) &colinfo, (void **) &colinfo_ind)))
        return(rval);

    (void)sprintf(delstmt,
        "DELETE FROM %s.%s_sbtree partition (DATAOBJ_TO_PARTITION(%s, :partiden))
        WHERE f2 = :rr",
        OCIStrngPtr(envhvp, ix->IndexSchema), OCIStrngPtr(envhvp, ix->IndexName),
        OCIStrngPtr(envhvp, colinfo->TableName));
}

/*****
* Parse and Execute delete Statement *
*****/

/* allocate stmt handle */
if (qxigtce(ctx, errhp, OCIHandleAlloc((dvoid *)envhvp, (dvoid **)&stmthp,
    (ub4)OCI_HTYPE_STMT, (size_t)0, (dvoid **)0)))
    return(rval);

/* prepare the statement */
if (qxigtce(ctx, errhp, OCISmtPrepare(stmthp, errhp, (text *)delstmt,
    (ub4)strlen(delstmt), OCI_NTV_SYNTAX, OCI_DEFAULT)))
    return(rval);

if ( ( idxflag & ODCI_INDEX_RANGE_PARTN) == ODCI_INDEX_RANGE_PARTN)
{
    /* Convert partiden to integer from OCINumber */
    if (qxigtce(ctx, errhp, OCINumberToInt(errhp, &(colinfo->TablePartitionIden),
        sizeof(partiden), OCI_NUMBER_UNSIGNED, ( void *)&partiden)))
        return(rval);

    /* Set up bind for partiden */
    if (qxigtce(ctx, errhp, OCIBindByName(stmthp, &bndp, errhp,
        (text *)":partiden", sizeof(":partiden")-1, (dvoid *)&partiden,
        sb4)(sizeof(partiden)), (ub2)SQLT_INT, (dvoid *)0, (ub2 *)0,
        (ub2 *)0, (ub4)0, (ub4 *)0, (ub4)OCI_DEFAULT)))
        return(rval);
}

/* Set up bind for rid */
if (qxigtce(ctx, errhp, OCIBindByName(stmthp, &bndp, errhp, (text *)":rr",
    sizeof(":rr")-1, (dvoid *)rid, (sb4)(strlen(rid)+1), (ub2)SQLT_STR,
    (dvoid *)0, (ub2 *)0, (ub2 *)0, (ub4)0, (ub4 *)0, (ub4)OCI_DEFAULT)))

```

```

        return(rval);

    /* Execute statement */
    if (qxiqtce(ctx, errhp, OCIStmtExecute(svchp, stmthp, errhp, (ub4)1, (ub4)0,
        (OCISnapshot *)NULL, (OCISnapshot *)NULL, (ub4)OCI_DEFAULT)))
        return(rval);

    /* free stmt handle */
    if (qxiqtce(ctx, errhp, OCIHandleFree((dvoid *)stmthp, (ub4)OCI_HTYPE_STMT)))
        return(rval);

    return(rval);
}

```

#### 16.4.6.4 Implementing ODCIIndexUpdate() for PSBTree in C

The update routine constructs a SQL statement to update a row in the index table corresponding to the row being updated in the base table. The row in the index table is identified by the value of `rowid` that is passed in as a parameter to this routine. The old column value (`oldval`) is replaced by the new value (`newval`).

```

OCINumber *qxiqtbpspu(
    OCIEExtProcContext *ctx,
    ODCIIndexInfo *ix,
    ODCIIndexInfo_ind *ix_ind,
    char *rid,
    short rid_ind,
    char *oldval,
    short oldval_ind,
    char *newval,
    short newval_ind,
    ODCIEnv *env,
    ODCIEnv_ind *env_ind)
{
    OCIEEnv *envhp = (OCIEEnv *) 0; /* env. handle */
    OCISvcCtx *svchp = (OCISvcCtx *) 0; /* service handle */
    OCIError *errhp = (OCIError *) 0; /* error handle */
    OCIStmt *stmthp = (OCIStmt *) 0; /* statement handle */
    OCIBind *bndp = (OCIBind *) 0; /* bind handle */

    int retval = (int)ODCI_SUCCESS; /* return from this function */
    OCINumber *rval = (OCINumber *)0;

    char updstmt[2000]; /* sql update statement */
    ODCIColInfo *colinfo; /* column info */
    ODCIColInfo_ind *colinfo_ind;
    boolean exists = TRUE;
    unsigned int partiden; /* table partition iden */
    unsigned int idxflag; /* index info flag

    /* Get oci handles */
    if (qxiqtce(ctx, errhp, OCIExtProcGetEnv(ctx, &envhp, &svchp, &errhp)))
        return(rval);

    /* set up return code */
    rval = (OCINumber *)OCIExtProcAllocCallMemory(ctx, sizeof(OCINumber));
    if (qxiqtce(ctx, errhp, OCINumberFromInt(errhp, (dvoid *)&retval,
        sizeof(retval), OCI_NUMBER_SIGNED, rval)))
        return(rval);
}

```

```

/* Convert idxflag to integer from OCINumber */
if (qxiqtce(ctx, errhp, OCINumberToInt(errhp, &(ix->IndexInfoFlags),
    sizeof(idxflag), OCI_NUMBER_UNSIGNED, ( void *)&idxflag)))
    return(rval);

/*****
* Construct update Statement *
*****/
if ( (idxflag & ODCI_INDEX_RANGE_PARTN) != ODCI_INDEX_RANGE_PARTN)
    (void)sprintf(updstmt, "UPDATE %s.%s_sbtrees SET f1 = :newval WHERE f2 = :rr",
        OCIStringPtr(envhp, ix->IndexSchema), OCIStringPtr(envhp, ix->IndexName));
else
{
    if (qxiqtce(ctx, errhp, OCICollGetElem(envhp, errhp, OCIColl *)ix->IndexCols,
        (sb4)0, &exists, (void **) &colinfo, (void **) &colinfo_ind))
        return(rval);

    (void)sprintf(updstmt, "UPDATE %s.%s_sbtrees partition
        (DATAOBJ_TO_PARTITION(%s, :partiden)) SET f1 = :newval WHERE f2 = :rr",
        OCIStringPtr(envhp, ix->IndexSchema), OCIStringPtr(envhp, ix->IndexName),
        OCIStringPtr(envhp, colinfo->TableName));
}

/*****
* Parse and Execute Create Statement *
*****/

/* allocate stmt handle */
if (qxiqtce(ctx, errhp, OCIHandleAlloc((dvoid *)envhp, (dvoid **)&stmthp,
    (ub4)OCI_HTYPE_STMT, (size_t)0, (dvoid **)0)))
    return(rval);

/* prepare the statement */
if (qxiqtce(ctx, errhp, OCIStmtPrepare(stmthp, errhp, (text *)updstmt,
    (ub4)strlen(updstmt), OCI_NTV_SYNTAX, OCI_DEFAULT)))
    return(rval);

if ( (idxflag & ODCI_INDEX_RANGE_PARTN) == ODCI_INDEX_RANGE_PARTN)
{
    /* Convert partiden to integer from OCINumber */
    if (qxiqtce(ctx, errhp, OCINumberToInt(errhp,
        &(colinfo->TablePartitionIden), sizeof(partiden), OCI_NUMBER_UNSIGNED,
        ( void *)&partiden)))
        return(rval);

    /* Set up bind for partiden */
    if (qxiqtce(ctx, errhp, OCIBindByName(stmthp, &bndp, errhp,
        (text *)":partiden", sizeof(":partiden")-1, (dvoid *)&partiden,
        (sb4)(sizeof(partiden)), (ub2)SQLT_INT, (dvoid *)0, (ub2 *)0,
        (ub2 *)0, (ub4)0, (ub4 *)0, (ub4)OCI_DEFAULT)))
        return(rval);
}

/* Set up bind for newval */
if (qxiqtce(ctx, errhp, OCIBindByName(stmthp, &bndp, errhp, (text *)":newval",
    sizeof(":newval")-1, (dvoid *)newval, (sb4)(strlen(newval)+1),
    (ub2)SQLT_STR, (dvoid *)0, (ub2 *)0, (ub2 *)0, (ub4)0, (ub4 *)0, (
    ub4)OCI_DEFAULT)))
    return(rval);

/* Set up bind for rid */

```

```

if (qxiqtce(ctx, errhp, OCIBindByName(stmthp, &bndp, errhp, (text *)":rr",
    sizeof(":rr")-1, (dvoid *)rid, (sb4)(strlen(rid)+1), (ub2)SQLT_STR,
    (dvoid *)0, (ub2 *)0, (ub2 *)0, (ub4)0, (ub4 *)0, (ub4)OCI_DEFAULT)))
    return(rval);

/* Execute statement */
if (qxiqtce(ctx, errhp, OCIStmtExecute(svchp, stmthp, errhp, (ub4)1,
    ub4)0, (OCI_Snapshot *)NULL, (OCI_Snapshot *)NULL, (ub4)OCI_DEFAULT)))
    return(rval);

/* free stmt handle */
if (qxiqtce(ctx, errhp, OCIHandleFree((dvoid *)stmthp, (ub4)OCI_HTYPE_STMT)))
    return(rval);

return(rval);
}

```

### 16.4.6.5 Implementing ODCIIndexStart() for PSBTREE in C

The start routine performs the setup for an `psbtree` index scan. The query information in terms of the operator predicate, its arguments, and the bounds on return values are passed in as parameters to this function. The scan context that is shared among the index scan routines is an instance of the type `psbtree_im`.

This function sets up a cursor that scans the index table. The scan retrieves the stored rowids for the rows in the index table that satisfy the specified predicate. The predicate for the index table is generated based on the operator predicate information that is passed in as parameters. For example, if the operator predicate is of the form `eq(col, 'joe') = 1`, then the predicate on the index table is set up to be `fl = 'joe'`.

This function uses the `structS` `qxiqtim`, `qxiqtin`, and `qxiqtctx`, which were demonstrated in [Example 16-6](#) and [Example 16-7](#).

```

OCINumber *qxiqtbpsps(
    OCIExtProcContext *ctx,
    qxiqtim           *sctx,
    qxiqtin          *sctx_ind,
    ODCIIndexInfo    *ix,
    ODCIIndexInfo_ind *ix_ind,
    ODCIPredInfo     *pr,
    ODCIPredInfo_ind *pr_ind,
    ODCIQueryInfo    *qy,
    ODCIQueryInfo_ind *qy_ind,
    OCINumber        *strt,
    short            strt_ind,
    OCINumber        *stop,
    short            stop_ind,
    char             *cmpval,
    short            cmpval_ind,
    OCIEnv           *env,
    OCIEnv_ind       *env_ind)
{
    sword status;
    OCIEnv *envhp = (OCIEnv *) 0;           /* env. handle */
    OCISvcCtx *svchp = (OCISvcCtx *) 0;    /* service handle */
    OCIError *errhp = (OCIError *) 0;      /* error handle */
    OCI_Session *usrhp = (OCI_Session *) 0; /* user handle */
    qxiqtctx *icx = (qxiqtctx *) 0;       /* state to be saved for later calls */

    int strtval;                          /* start bound */

```

```

int stopval;                /* stop bound */

int errnum = 29400;         /* choose some oracle error number */
char errmsg[512];          /* error message buffer */
size_t errmsglen;          /* Length of error message */

char relop[3];              /* relational operator used in sql stmt */
char selstmt[2000];         /* sql select statement */

int retval = (int)ODCI_SUCCESS; /* return from this function */
OCINumber *rval = (OCINumber *)0;
ub4 key;                    /* key value set in "sctx" */

ub1 *rkey;                  /* key to retrieve context */
ub4 rkeylen;                /* length of key */
ODCIColInfo *colinfo;      /* column info */
ODCIColInfo_ind *colinfo_ind;
boolean exists = TRUE;
unsigned int partiden;      /* table partition iden */
unsigned int idxflag;       /* index info flag

/* Get oci handles */
if (qxiqtce(ctx, errhp, OCIExtProcGetEnv(ctx, &envhp, &svchp, &errhp))
    return(retval);

/* set up return code */
rval = (OCINumber *)OCIExtProcAllocCallMemory(ctx, sizeof(OCINumber));
if (qxiqtce(ctx, errhp, OCINumberFromInt(errhp, (dvoid *)&retval,
    sizeof(retval), OCI_NUMBER_SIGNED, rval)))
    return(retval);

/* get the user handle */
if (qxiqtce(ctx, errhp, OCIAttrGet((dvoid *)svchp, (ub4)OCI_HTYPE_SVCCTX,
    (dvoid *)&usrhp, (ub4 *)0, (ub4)OCI_ATTR_SESSION, errhp))
    return(retval);

/*****
/* Allocate memory to hold index scan context */
*****/
if (sctx_ind ->atomic_qxiqtin == OCI_IND_NULL ||
    sctx_ind ->scind_qxiqtin == OCI_IND_NULL)
{
    if (qxiqtce(ctx, errhp, OCIMemoryAlloc((dvoid *)usrhp, errhp, (dvoid **)&icx,
        OCI_DURATION_STATEMENT, (ub4)(sizeof(qxiqtctx)), OCI_MEMORY_CLEARED)))
        return(retval);

    icx->stmthp = (OCISmt *)0;
    icx->defnp = (OCIDefine *)0;
    icx->bndp = (OCIBind *)0;
}

else
{
    /*****
    /* Retrieve scan context */
    *****/
    rkey = OCIRawPtr(envhp, sctx->sctx_qxiqtin);
    rkeylen = OCIRawSize(envhp, sctx->sctx_qxiqtin);

    if (qxiqtce(ctx, errhp, OCIContextGetValue((dvoid *)usrhp, errhp,
        rkey, (ub1)rkeylen, (dvoid **)&(icx))))

```

```

        return(rval);
    }

    /*****
    /* Check that the bounds are valid */
    /*****
    /* convert from oci numbers to native numbers */
    if (qxigtce(ctx, errhp, OCINumberToInt(errhp, strt, sizeof(strtval),
        OCI_NUMBER_SIGNED, (dvoid *)&strtval)))
        return(rval);

    if (qxigtce(ctx, errhp, OCINumberToInt(errhp, stop, sizeof(stopval),
        OCI_NUMBER_SIGNED, (dvoid *)&stopval)))
        return(rval);

    /* verify that strtval/stopval are both either 0 or 1 */
    if (!(((strtval == 0) && (stopval == 0)) || ((strtval == 1) && (stopval == 1))))
    {
        strcpy(errmsg, (char *)"Incorrect predicate for sbtree operator");
        errmsglen = (size_t)strlen(errmsg);
        if (OCIExtProcRaiseExcpWithMsg(ctx, errnum, (text *)errmsg, errormsglen)
            != OCIEXTPROC_SUCCESS)
            /* Use cartridge error services here */;
        return(rval);
    }

    /*****
    /* Generate the SQL statement to be executed */
    /*****
    if (memcmp((dvoid *)OCIStringPtr(envhp, pr->ObjectName), (dvoid *)"EQ", 2) == 0)
        if (strtval == 1)
            strcpy(relop, (char *)"=");
        else
            strcpy(relop, (char *)"!=");
        else if
            (memcmp((dvoid *)OCIStringPtr(envhp, pr->ObjectName), (dvoid *)"LT", 2) == 0)
            if (strtval == 1)
                strcpy(relop, (char *)"<");
            else
                strcpy(relop, (char *)">=");
            else
                if (strtval == 1)
                    strcpy(relop, (char *)">");
                else
                    strcpy(relop, (char *)"<=");

    /* Convert idxflag to integer from OCINumber */
    if (qxigtce(ctx, errhp, OCINumberToInt(errhp, &(ix->IndexInfoFlags),
        sizeof(idxflag), OCI_NUMBER_UNSIGNED, (void *)&idxflag)))
        return(rval);

    if ( (idxflag & ODCI_INDEX_RANGE_PARTN) != ODCI_INDEX_RANGE_PARTN)
        (void)sprintf(selstmt, "select f2 from %s.%s_sbtree where f1 %s :val",
            OCIStringPtr(envhp, ix->IndexSchema), OCIStringPtr(envhp, ix->IndexName),
            relop);
    else
    {
        if (qxigtce(ctx, errhp, OCICollGetElem(envhp, errhp, OCIColl *)ix->IndexCols,
            (sb4)0, &exists, (void **) &colinfo, (void **) &colinfo_ind)))
            return(rval);
    }

```

```

/* Convert partiden to integer from OCINumber */
if (qxigtce(ctx, errhp, OCINumberToInt(errhp, &(colinfo->TablePartitionIden),
    sizeof(partiden), OCI_NUMBER_UNSIGNED, ( void *)&partiden)))
    return(rval);

(void)sprintf(selstmt, "select f2 from %s.%s_sbtrees partition
    (DATAOBJ_TO_PARTITION(%s, %d)) where f1 %s :val",
    OCIStringPtr(envhp, ix->IndexSchema), OCIStringPtr(envhp, ix->IndexName),
    OCIStringPtr(envhp, colinfo->TableName), partiden, relop);
}

/*****
/* Parse, bind, define and execute */
*****/
if (sctx_ind ->atomic_qxigtin == OCI_IND_NULL ||
    sctx_ind ->scind_qxigtin == OCI_IND_NULL)
{
    /* allocate stmt handle */
    if (qxigtce(ctx, errhp, OCIHandleAlloc((dvoid *)envhp,
        (dvoid **)&(icx->stmthp), (ub4)OCI_HTYPE_STMT, (size_t)0, (dvoid **)0)))
        return(rval);
}

/* prepare the statement */
if (qxigtce(ctx, errhp, OCIStmtPrepare(icx->stmthp, errhp, (text *)selstmt,
    (ub4)strlen(selstmt), OCI_NTV_SYNTAX, OCI_DEFAULT)))
    return(rval);

/* Set up bind for compare value */
if (qxigtce(ctx, errhp, OCIBindByName(icx->stmthp, &(icx->bndp), errhp,
    (text *)":val", sizeof(":val")-1, (dvoid *)cmpval, (sb4)(strlen(cmpval)+1),
    (ub2)SQLT_STR, (dvoid *)0, (ub2 *)0, (ub2 *)0, (ub4)0, (ub4 *)0,
    (ub4)OCI_DEFAULT)))
    return(rval);

/* Set up define */
if (qxigtce(ctx, errhp, OCIDefineByPos(icx->stmthp, &(icx->defnp), errhp,
    (ub4)1, (dvoid *)(&(icx->ridp)), (sb4) sizeof(icx->ridp), (ub2)SQLT_STR,
    (dvoid *)0, (ub2 *)0, (ub2 *)0, (ub4)OCI_DEFAULT)))
    return(rval);

/* execute */
if (qxigtce(ctx, errhp, OCIStmtExecute(svchp, icx->stmthp, errhp, (ub4)0,
    (ub4)0, (OCISnapshot *)NULL, (OCISnapshot *)NULL, (ub4)OCI_DEFAULT)))
    return(rval);

/*****
/* Set index context to be returned */
*****/
if (sctx_ind ->atomic_qxigtin == OCI_IND_NULL ||
    sctx_ind ->scind_qxigtin == OCI_IND_NULL)
{
    /* generate a key */
    if (qxigtce(ctx, errhp, OCIContextGenerateKey((dvoid *)usrhp, errhp, &key)))
        return(rval);

    /* set the memory address of the struct to be saved in the context */
    if (qxigtce(ctx, errhp, OCIContextSetValue((dvoid *)usrhp, errhp,
        OCI_DURATION_STATEMENT, (ub1 *)&key, (ub1)sizeof(key), (dvoid *)icx)))
        return(rval);
}

```

```

/* statement duration memory alloc for key */
if (qxigtce(ctx, errhp, OCIMemoryAlloc(( void *)usrhp, errhp,
    ( void **)&(sctx->sctx_qxigtim), OCI_DURATION_STATEMENT,
    (sb4)(sizeof(key)+sizeof(ub4)), OCI_MEMORY_CLEARED)))
    return(rval);

/* set the key as the member of "sctx" */
if (qxigtce(ctx, errhp, OCIRawAssignBytes(envhp, errhp, (ub1 *)&key,
    ub4)sizeof(key), &(sctx->sctx_qxigtim)))
    return(rval);

sctx_ind->atomic_qxigtin = OCI_IND_NOTNULL;
sctx_ind->scind_qxigtin = OCI_IND_NOTNULL;

return(rval);
}

return(rval);
}

```

### 16.4.6.6 Implementing ODCIIndexFetch() for PSBTREE in C

The scan context set up by the start routine is passed in as a parameter to the fetch routine. This function first retrieves the 4-byte key from the scan context. The C mapping for the scan context is `qxigtim` (see [Example 16-6](#)). Next, key is used to look up the OCI context. This gives the memory address of the `qxigtctx` structure (see [Example 16-7](#)) that holds the OCI handles.

This function returns the next batch of rowids that satisfy the operator predicate. It uses the value of the `nrows` parameter as the size of the batch. It repeatedly fetches rowids from the open cursor and populates the `rowid` list. When the batch is full or when there are no more rowids left, the function returns them back to the Oracle server.

```

OCINumber *qxigtbspf(
    OCIEExtProcContext *ctx,
    qxigtim             *self,
    qxigtin             *self_ind,
    OCINumber           *nrows,
    short               nrows_ind,
    OCIArray            **rids,
    short               *rids_ind,
    ODCIEnv             *env,
    ODCIEnv_ind         *env_ind)
{
    sword status;
    ODCIEnv *envhp = (ODCIEnv *) 0;           /* env. handle */
    OCISvcCtx *svchp = (OCISvcCtx *) 0;      /* service handle */
    OCIError *errhp = (OCIError *) 0;        /* error handle */
    OCISession *usrhp = (OCISession *) 0;    /* user handle */
    qxigtctx *icx = (qxigtctx *) 0;         /* state to be saved for later calls */

    int idx = 1;
    int nrowsval;

    OCIArray *ridarrp = *rids;               /* rowid collection */
    OCIStr *ridstr = (OCIStr *)0;

    int done = 0;
    int retval = (int)ODCI_SUCCESS;
}

```



```

OCINumber *rval = (OCINumber *)0;

ub1 *key;                /* key to retrieve context */
ub4 keylen;              /* length of key */

/*****/
/* Get OCI handles */
/*****/
if (qxigtce(ctx, errhp, OCIExtProcGetEnv(ctx, &envhp, &svchp, &errhp))
    return(rval);

/* set up return code */
rval = (OCINumber *)OCIExtProcAllocCallMemory(ctx, sizeof(OCINumber));
if (qxigtce(ctx, errhp, OCINumberFromInt(errhp, (dvoid *)&retval,
    sizeof(retval), OCI_NUMBER_SIGNED, rval)))
    return(rval);

/* get the user handle */
if (qxigtce(ctx, errhp, OCIAttrGet((dvoid *)svchp, (ub4)OCI_HTYPE_SVCCTX,
    (dvoid *)&usrhp, (ub4 *)0, (ub4)OCI_ATTR_SESSION, errhp))
    return(rval);

/*****/
/* Retrieve context from key */
/*****/
key = OCIRawPtr(envhp, self->sctx_qxigtim);
keylen = OCIRawSize(envhp, self->sctx_qxigtim);

if (qxigtce(ctx, errhp, OCIContextGetValue((dvoid *)usrhp, errhp, key,
    (ub1)keylen, (dvoid **)&(icx)))
    return(rval);

/* get value of nrows */
if (qxigtce(ctx, errhp, OCINumberToInt(errhp, nrows, sizeof(nrowsval),
    OCI_NUMBER_SIGNED, (dvoid *)&nrowsval))
    return(rval);

/*****/
/* Fetch rowids */
/*****/
while (!done)
{
    if (idx > nrowsval)
        done = 1;
    else
    {
        status = OCISmtFetch(icx->stmthp, errhp, (ub4)1, (ub2) 0, (ub4)OCI_DEFAULT);
        if (status == OCI_NO_DATA)
        {
            short col_ind = OCI_IND_NULL;
            /* have to create dummy oci string */
            OCIStringAssignText(envhp, errhp, (text *)"dummy", (ub2)5, &ridstr);
            /* append null element to collection */
            if (qxigtce(ctx, errhp, OCICollAppend(envhp, errhp, (dvoid *)ridstr,
                (dvoid *)&col_ind, (OCIColl *)ridarrp)))
                return(rval);
            done = 1;
        }
        else if (status == OCI_SUCCESS)
        {
            OCIStringAssignText(envhp, errhp, (text *)icx->ridp, (ub2)18,

```

```

        OCIStrng **) &ridstr);
    /* append rowid to collection */
    if (qxigtce(ctx, errhp, OCICollAppend(envhp, errhp, (dvoid *)ridstr,
        (dvoid *)0, (OCIColl *)ridarrp)))
        return(rval);
    idx++;
}
else if (qxigtce(ctx, errhp, status))
    return(rval);
}
}

/* free ridstr finally */
if (ridstr &&
    (qxigtce(ctx, errhp, OCIStrngResize(envhp, errhp, (ub4)0, &ridstr))))
    return(rval);

*rids_ind = OCI_IND_NOTNULL;

return(rval);
}

```

### 16.4.6.7 Implementing ODCIIndexClose() for PSBTREE in C

The scan context set up by the start routine is passed in as a parameter to the close routine. This function first retrieves the 4-byte key from the scan context. The C mapping for the scan context is `qxigtim` (see [Example 16-6](#)). Next, the OCI context is looked up based on the key. This gives the memory address of the structure that holds the OCI handles, the `qxigtctx` structure (see [Example 16-7](#)).

This function closes and frees all the OCI handles. It also frees the memory that was allocated in the start routine.

```

OCINumber *qxigtbspc(
    OCIEExtProcContext *ctx,
    qxigtim             *self,
    qxigtin             *self_ind,
    ODCIEnv             *env,
    ODCIEnv_ind         *env_ind)
{
    sword status;
    OCIEEnv *envhp = (OCIEEnv *) 0;           /* env. handle */
    OCISvcCtx *svchp = (OCISvcCtx *) 0;      /* service handle */
    OCIError *errhp = (OCIError *) 0;        /* error handle */
    OCISession *usrhp = (OCISession *) 0;    /* user handle */
    qxigtctx *icx = (qxigtctx *) 0;         /* state to be saved for later calls */

    int retval = (int) ODCI_SUCCESS;
    OCINumber *rval = (OCINumber *) 0;

    ub1 *key;                               /* key to retrieve context */
    ub4 keylen;                              /* length of key */

    if (qxigtce(ctx, errhp, OCIEExtProcGetEnv(ctx, &envhp, &svchp, &errhp)))
        return(rval);

    /* set up return code */
    rval = (OCINumber *) OCIEExtProcAllocCallMemory(ctx, sizeof(OCINumber));
    if (qxigtce(ctx, errhp, OCINumberFromInt(errhp, (dvoid *)&retval,
        sizeof(retval), OCI_NUMBER_SIGNED, rval)))

```

```

        return(rval);

/* get the user handle */
if (qxiqtce(ctx, errhp, OCIAttrGet((dvoid *)svchp, (ub4)OCI_HTYPE_SVCCTX,
    (dvoid *)&usrhp, (ub4 *)0,
    (ub4)OCI_ATTR_SESSION, errhp)))
    return(rval);
/*****/
/* Retrieve context using key */
/*****/
key = OCIRawPtr(envhp, self->sctx_qxiqtim);
keylen = OCIRawSize(envhp, self->sctx_qxiqtim);

if (qxiqtce(ctx, errhp, OCIContextGetValue((dvoid *)usrhp, errhp, key,
    (ubl)keylen, (dvoid **)&(icx))))
    return(rval);

/* Free handles and memory */
if (qxiqtce(ctx, errhp, OCIHandleFree((dvoid *)icx->stmthp,
    (ub4)OCI_HTYPE_STMT)))
    return(rval);

if (qxiqtce(ctx, errhp, OCIMemoryFree((dvoid *)usrhp, errhp, (dvoid *)icx)))
    return(rval);

/* free the memory allocated for the index context. */
if (qxiqtce(ctx, errhp, OCIContextClearValue((dvoid *)usrhp, errhp, key,
    (ubl)keylen)))
    return(rval);

    return(rval);
}

```

## 16.4.7 Implementing the Indextype for PSBTREE

You should create the indextype object and specify the list of operators that it supports. In addition, specify the name of the implementation type that implements the `ODCIIndexXXX()` interface routines.

```

CREATE INDEXTYPE psbtree
FOR
    eq(VARCHAR2, VARCHAR2),
    lt(VARCHAR2, VARCHAR2),
    gt(VARCHAR2, VARCHAR2)
USING psbtree_im
WITH LOCAL RANGE PARTITION
WITH SYSTEM MANAGED STORAGE TABLES

```

## 16.5 Using PSBTREE

You should next create the indextype object and specify the list of operators that it supports. In addition, specify the name of the implementation type that implements the `ODCIIndexXXX()` interface routines. This step is demonstrated in the [Implementing the Indextype for PSBTREE](#) section.

One typical usage scenario is to create a range partitioned table and populate it, as demonstrated in the [Creating and Populating a Partitioned Table for PSBTREE](#) section.

You can then create a `psbtree` index on column `f2`. The `CREATE INDEX` statement specifies the `indextype` that should be used, as demonstrated in the [Creating a PSBTREE Index on a Column](#) section.

To execute a query that uses one of the `psbtree` operators, use the code in the [Using PSBTREE Operators in a Query](#) section.

## 16.5.1 Creating and Populating a Partitioned Table for PSBTREE

```
CREATE TABLE t1 (f1 NUMBER, f2 VARCHAR2(200))
PARTITION BY RANGE(f1)
(
  PARTITION p1 VALUES LESS THAN (101),
  PARTITION p2 VALUES LESS THAN (201),
  PARTITION p3 VALUES LESS THAN (301),
  PARTITION p4 VALUES LESS THAN (401)
);
INSERT INTO t1 VALUES (10, 'aaaa');
INSERT INTO t1 VALUES (200, 'bbbb');
INSERT INTO t1 VALUES (100, 'cccc');
INSERT INTO t1 VALUES (300, 'dddd');
INSERT INTO t1 VALUES (400, 'eeee');
COMMIT;
```

## 16.5.2 Creating a PSBTREE Index on a Column

```
CREATE INDEX it1 ON t1(f2) INDEXTYPE IS psbtree LOCAL
(PARTITION pe1 PARAMETERS('test1'), PARTITION pe2,
 PARTITION pe3, PARTITION pe4 PARAMETERS('test4'))
PARAMETERS('test');
```

## 16.5.3 Using PSBTREE Operators in a Query

```
SELECT * FROM t1 WHERE eq(f2, 'dddd') = 1 AND f1>101 ;
```

The explain plan output for this query should look like this:

OPERATION	OPTIONS	PARTITION_START	PARTITION_STOP
SELECT STATEMENT			
PARTITION RANGE	ITERATOR	2	4
TABLE ACCESS	BY LOCAL INDEX ROWID	2	4
DOMAIN INDEX			

# 17

## Pipelined Table Functions: Interface Approach Example

Two complete implementations of the `StockPivot` pipelined table function using the interface approach are described. One implementation is in C, and the other is in Java.

The function `StockPivot` converts a row of the type `(Ticker, OpenPrice, ClosePrice)` into two rows of the form `(Ticker, PriceType, Price)`. For example, from an input row `("ORCL", 41, 42)`, the table function returns the two rows `("ORCL", "O", 41)` and `("ORCL", "C", 42)`.



### Tip:

Consider the table functions described in [Using Pipelined and Parallel Table Functions](#).

## 17.1 Pipelined Table Functions Example: C Implementation

In this example, the three `ODCItable` interface methods of the implementation type are implemented as external functions in C. These methods must first be declared in SQL.

### 17.1.1 Making SQL Declarations for C Implementation

[Example 17-1](#) shows how to make SQL declarations for the methods implemented in C language in [Implementation ODCItable Methods in C](#).

#### Example 17-1 Making SQL Declarations for Implementing ODCItableXXX() in C

```
-- Create the input stock table
CREATE TABLE StockTable (
  ticker VARCHAR(4),
  openprice NUMBER,
  closeprice NUMBER
);

-- Create the types for the table function's output collection
-- and collection elements

CREATE TYPE TickerType AS OBJECT
(
  ticker VARCHAR2(4),
  PriceType VARCHAR2(1),
  price NUMBER
);
/

CREATE TYPE TickerTypeSet AS TABLE OF TickerType;
/
```

```
-- Create the external library object
CREATE LIBRARY StockPivotLib IS '/home/bill/libstock.so';
/

-- Create the implementation type
CREATE TYPE StockPivotImpl AS OBJECT
(
  key RAW(4),

  STATIC FUNCTION ODCITableStart(
    sctx OUT StockPivotImpl,
    cur SYS_REFCURSOR)
  RETURN PLS_INTEGER
  AS LANGUAGE C
  LIBRARY StockPivotLib
  NAME "ODCITableStart"
  WITH CONTEXT
  PARAMETERS (context, sctx, sctx INDICATOR STRUCT, cur, RETURN INT),

  MEMBER FUNCTION ODCITableFetch(
    self IN OUT StockPivotImpl,
    nrows IN NUMBER,
    outSet OUT TickerTypeSet)
  RETURN PLS_INTEGER
  AS LANGUAGE C
  LIBRARY StockPivotLib
  NAME "ODCITableFetch"
  WITH CONTEXT
  PARAMETERS (context, self, self INDICATOR STRUCT, nrows, outSet,
    outSet INDICATOR, RETURN INT),

  MEMBER FUNCTION ODCITableClose(
    self IN StockPivotImpl)
  RETURN PLS_INTEGER
  AS LANGUAGE C
  LIBRARY StockPivotLib
  NAME "ODCITableClose"
  WITH CONTEXT
  PARAMETERS (context, self, self INDICATOR STRUCT, RETURN INT)
);
/

-- Define the ref cursor type
CREATE PACKAGE refcur_pkg IS
  TYPE refcur_t IS REF CURSOR RETURN StockTable%ROWTYPE;
END refcur_pkg;
/

-- Create table function
CREATE FUNCTION StockPivot(p refcur_pkg.refcur_t) RETURN TickerTypeSet
PIPELINED USING StockPivotImpl;
/
```

## 17.1.2 Implementation ODCITable Methods in C

[Example 17-2](#) implements the three ODCITable methods as external functions in C.

**Example 17-2 Implementing ODCTableXXX() Methods in C**

```

#ifndef OCI_ORACLE
#include <oci.h>
#endif
#ifndef ODCI_ORACLE
#include <odci.h>
#endif

/*-----
PRIVATE TYPES AND CONSTANTS
-----*/

/* The struct holding the user's stored context */

struct StoredCtx
{
    OCIStmt* stmthp;
};
typedef struct StoredCtx StoredCtx;

/* OCI Handles */

struct Handles_t
{
    OCIExtProcContext* extProcCtx;
    OCIEnv* envhvp;
    OCISvcCtx* svchp;
    OCIError* errhp;
    OCISession* usrhvp;
};
typedef struct Handles_t Handles_t;

/***** SQL Types C representation *****/

/* Table function's implementation type */

struct StockPivotImpl
{
    OCIRaw* key;
};
typedef struct StockPivotImpl StockPivotImpl;

struct StockPivotImpl_ind
{
    short _atomic;
    short key;
};
typedef struct StockPivotImpl_ind StockPivotImpl_ind;

/* Table function's output collection element type */

struct TickerType
{
    OCIStr* ticker;
    OCIStr* PriceType;
    OCINumber price;
};
typedef struct TickerType TickerType;

struct TickerType_ind

```

```

{
    short _atomic;
    short ticker;
    short PriceType;
    short price;
};
typedef struct TickerType_ind TickerType_ind;

/* Table function's output collection type */

typedef OCITable TickerTypeSet;

/*-----*/
/* Static Functions */
/*-----*/

static int GetHandles(OCIExtProcContext* extProcCtx, Handles_t* handles);

static StoredCtx* GetStoredCtx(Handles_t* handles, StockPivotImpl* self,
                               StockPivotImpl_ind* self_ind);

static int checkerr(Handles_t* handles, sword status);

/*-----*/
/* Functions definitions */
/*-----*/

/* Callout for ODCITableStart */

int ODCITableStart(OCIExtProcContext* extProcCtx, StockPivotImpl* self,
                  StockPivotImpl_ind* self_ind, OCIStmt** cur)
{
    Handles_t handles;                /* OCI handles */
    StoredCtx* storedCtx;             /* Stored context pointer */

    ub4 key;                          /* key to retrieve stored context */

    /* Get OCI handles */
    if (GetHandles(extProcCtx, &handles))
        return ODCI_ERROR;

    /* Allocate memory to hold the stored context */
    if (checkerr(&handles, OCIMemoryAlloc((dvoid*) handles.usrhp, handles.errhp,
                                          (dvoid**) &storedCtx,
                                          OCI_DURATION_STATEMENT,
                                          (ub4) sizeof(StoredCtx),
                                          OCI_MEMORY_CLEARED)))
        return ODCI_ERROR;

    /* store the input ref cursor in the stored context */
    storedCtx->stmthp=*cur;

    /* generate a key */
    if (checkerr(&handles, OCIContextGenerateKey((dvoid*) handles.usrhp,
                                                handles.errhp, &key)))
        return ODCI_ERROR;

    /* associate the key value with the stored context address */
    if (checkerr(&handles, OCIContextSetValue((dvoid*)handles.usrhp,
                                             handles.errhp,
                                             OCI_DURATION_STATEMENT,

```



```

                                (ub1*) &key, (ub1) sizeof(key),
                                (dvoid*) storedCtx))

    return ODCI_ERROR;

/* stored the key in the scan context */
if (checkerr(&handles, OCIRawAssignBytes(handles.envhp, handles.errhp,
                                (ub1*) &key, (ub4) sizeof(key),
                                &(self->key))))

    return ODCI_ERROR;

/* set indicators of the scan context */
self_ind->_atomic = OCI_IND_NOTNULL;
self_ind->key = OCI_IND_NOTNULL;

*cur=(OCISmt * )0;

return ODCI_SUCCESS;
}

/*****

/* Callout for ODCITableFetch */

int ODCITableFetch(OCIExtProcContext* extProcCtx, StockPivotImpl* self,
                  StockPivotImpl_ind* self_ind, OCINumber* nrows,
                  TickerTypeSet** outSet, short* outSet_ind)
{
    Handles_t handles;                /* OCI handles */
    StoredCtx* storedCtx;              /* Stored context pointer */
    int nrow sval;                    /* number of rows to return */

    /* Get OCI handles */
    if (GetHandles(extProcCtx, &handles))
        return ODCI_ERROR;

    /* Get the stored context */
    storedCtx=GetStoredCtx(&handles,self,self_ind);
    if (!storedCtx) return ODCI_ERROR;

    /* get value of nrows */
    if (checkerr(&handles, OCINumberToInt(handles.errhp, nrows, sizeof(nrow sval),
                                OCI_NUMBER_SIGNED, (dvoid *)&nrow sval)))

        return ODCI_ERROR;

    /* return up to 10 rows at a time */
    if (nrow sval>10) nrow sval=10;

    /* Initially set the output to null */
    *outSet_ind=OCI_IND_NULL;

    while (nrow sval>0)
    {

        TickerType elem;                /* current collection element */
        TickerType_ind elem_ind;        /* current element indicator */

        OCIDefine* defnp1=(OCIDefine*)0; /* define handle */
        OCIDefine* defnp2=(OCIDefine*)0; /* define handle */
        OCIDefine* defnp3=(OCIDefine*)0; /* define handle */

        sword status;

```

```

char ticker[5];
float openprice;
float closeprice;
char PriceType[2];

/* Define the fetch buffer for ticker symbol */
if (checkerr(&handles, OCIDefineByPos(storedCtx->stmthp, &defnp1,
                                     handles.errhp, (ub4) 1,
                                     (dvoid*) &ticker,
                                     (sb4) sizeof(ticker),
                                     SQLT_STR, (dvoid*) 0, (ub2*) 0,
                                     (ub2*) 0, (ub4) OCI_DEFAULT)))

    return ODCI_ERROR;

/* Define the fetch buffer for open price */
if (checkerr(&handles, OCIDefineByPos(storedCtx->stmthp, &defnp2,
                                     handles.errhp, (ub4) 2,
                                     (dvoid*) &openprice,
                                     (sb4) sizeof(openprice),
                                     SQLT_FLT, (dvoid*) 0, (ub2*) 0,
                                     (ub2*) 0, (ub4) OCI_DEFAULT)))

    return ODCI_ERROR;

/* Define the fetch buffer for closing price */
if (checkerr(&handles, OCIDefineByPos(storedCtx->stmthp, &defnp3,
                                     handles.errhp, (ub4) 3,
                                     (dvoid*) &closeprice,
                                     (sb4) sizeof(closeprice),
                                     SQLT_FLT, (dvoid*) 0, (ub2*) 0,
                                     (ub2*) 0, (ub4) OCI_DEFAULT)))

    return ODCI_ERROR;

/* fetch a row from the input ref cursor */
status = OCIStmtFetch(storedCtx->stmthp, handles.errhp, (ub4) 1,
                     (ub4) OCI_FETCH_NEXT, (ub4) OCI_DEFAULT);

/* finished if no more data */
if (status!=OCI_SUCCESS && status!=OCI_SUCCESS_WITH_INFO) break;

/* Initialize the element indicator struct */

elem_ind._atomic=OCI_IND_NOTNULL;
elem_ind.ticker=OCI_IND_NOTNULL;
elem_ind.PriceType=OCI_IND_NOTNULL;
elem_ind.price=OCI_IND_NOTNULL;

/* assign the ticker name */
elem.ticker=NULL;
if (checkerr(&handles, OCIStringAssignText(handles.envhp, handles.errhp,
                                         (text*) ticker,
                                         (ub2) strlen(ticker),
                                         &elem.ticker)))

    return ODCI_ERROR;

/* assign the price type */
elem.PriceType=NULL;
sprintf(PriceType,"0");
if (checkerr(&handles, OCIStringAssignText(handles.envhp, handles.errhp,
                                         (text*) PriceType,
                                         (ub2) strlen(PriceType),

```

```

        &elem.PriceType)))

    return ODCI_ERROR;

/* assign the price */
if (checkerr(&handles, OCINumberFromReal(handles.errhp, &openprice,
                                        sizeof(openprice), &elem.price)))

    return ODCI_ERROR;

/* append element to output collection */
if (checkerr(&handles, OCICollAppend(handles.envhp, handles.errhp,
                                    &elem, &elem_ind, *outSet)))

    return ODCI_ERROR;

/* assign the price type */
elem.PriceType=NULL;
sprintf(PriceType, "C");
if (checkerr(&handles, OCIStringAssignText(handles.envhp, handles.errhp,
                                          (text*) PriceType,
                                          (ub2) strlen(PriceType),
                                          &elem.PriceType)))

    return ODCI_ERROR;

/* assign the price */
if (checkerr(&handles, OCINumberFromReal(handles.errhp, &closeprice,
                                        sizeof(closeprice), &elem.price)))

    return ODCI_ERROR;

/* append row to output collection */
if (checkerr(&handles, OCICollAppend(handles.envhp, handles.errhp,
                                    &elem, &elem_ind, *outSet)))

    return ODCI_ERROR;

/* set collection indicator to not null */
*outSet_ind=OCI_IND_NOTNULL;

    nrowsval-=2;
}

return ODCI_SUCCESS;
}

/*****

/* Callout for ODCITableClose */

int ODCITableClose(OCIExtProcContext* extProcCtx, StockPivotImpl* self,
                  StockPivotImpl_ind* self_ind)
{
    Handles_t handles;                /* OCI handles */
    StoredCtx* storedCtx;            /* Stored context pointer */

    /* Get OCI handles */
    if (GetHandles(extProcCtx, &handles))
        return ODCI_ERROR;

    /* Get the stored context */
    storedCtx=GetStoredCtx(&handles,self,self_ind);
    if (!storedCtx) return ODCI_ERROR;

    /* Free the memory for the stored context */
    if (checkerr(&handles, OCIMemoryFree((dvoid*) handles.usrhp, handles.errhp,

```

```

                                (dvoid*) storedCtx))

    return OCI_ERROR;

    return OCI_SUCCESS;
}

/*****

/* Get the stored context using the key in the scan context */

static StoredCtx* GetStoredCtx(Handles_t* handles, StockPivotImpl* self,
                               StockPivotImpl_ind* self_ind)
{
    StoredCtx *storedCtx;          /* Stored context pointer */
    ub1 *key;                      /* key to retrieve context */
    ub4 keylen;                    /* length of key */

    /* return NULL if the PL/SQL context is NULL */
    if (self_ind->_atomic == OCI_IND_NULL) return NULL;

    /* Get the key */
    key = OCIRawPtr(handles->envhp, self->key);
    keylen = OCIRawSize(handles->envhp, self->key);

    /* Retrieve stored context using the key */
    if (checkerr(handles, OCIContextGetValue((dvoid*) handles->usrhp,
                                             handles->errhp,
                                             key, (ub1) keylen,
                                             (dvoid**) &storedCtx)))

        return NULL;

    return storedCtx;
}

/*****

/* Get OCI handles using the ext-proc context */

static int GetHandles(OCIExtProcContext* extProcCtx, Handles_t* handles)
{
    /* store the ext-proc context in the handles struct */
    handles->extProcCtx=extProcCtx;

    /* Get OCI handles */
    if (checkerr(handles, OCIExtProcGetEnv(extProcCtx, &handles->envhp,
                                           &handles->svchp, &handles->errhp)))

        return -1;

    /* get the user handle */
    if (checkerr(handles, OCIAttrGet((dvoid*)handles->svchp,
                                     (ub4)OCI_HTYPE_SVCCTX,
                                     (dvoid*)&handles->usrhp,
                                     (ub4*) 0, (ub4)OCI_ATTR_SESSION,
                                     handles->errhp)))

        return -1;

    return 0;
}

/*****

```

```

/* Check the error status and throw exception if necessary */

static int checkerr(Handles_t* handles, sword status)
{
    text errbuf[512];      /* error message buffer */
    sb4 errcode;          /* OCI error code */

    switch (status)
    {
        case OCI_SUCCESS:
        case OCI_SUCCESS_WITH_INFO:
            return 0;
        case OCI_ERROR:
            OCIErrorGet ((dvoid*) handles->errhp, (ub4) 1, (text *) NULL, &errcode,
                        errbuf, (ub4) sizeof(errbuf), (ub4) OCI_HTYPE_ERROR);
            sprintf((char*)errbuf, "OCI ERROR code %d",errcode);
            break;
        default:
            sprintf((char*)errbuf, "Warning - error status %d",status);
            break;
    }

    OCIExtProcRaiseExcpWithMsg(handles->extProcCtx, 29400, errbuf,
                               strlen((char*)errbuf));

    return -1;
}

```

## 17.2 Pipelined Table Functions Example: Java Implementation

In this example, the declaration of the implementation type references Java methods instead of C functions. This is the only change from the preceding, C example: all the other objects (`TickerType`, `TickerTypeSet`, `refcur_pkg`, `StockTable`, and `StockPivot`) are the same. These methods must first be declared in SQL.

### 17.2.1 Making SQL Declarations for Java Implementation

[Example 17-3](#) shows how to make SQL declarations for the methods implemented in C language in [Implementing the ODCI Table Methods in Java](#).

#### **Example 17-3 Making SQL Declarations for Implementing OCITableXXX() in Java**

```

// create the directory object

CREATE OR REPLACE DIRECTORY JavaDir AS '/home/bill/Java';

// compile the java source

CREATE AND COMPILE JAVA SOURCE NAMED source01
USING BFILE (JavaDir,'StockPivotImpl.java');
/
show errors

-- Create the implementation type

```

```

CREATE TYPE StockPivotImpl AS OBJECT
(
  key INTEGER,

  STATIC FUNCTION ODCITableStart(sctx OUT StockPivotImpl, cur SYS_REFCURSOR)
    RETURN NUMBER
    AS LANGUAGE JAVA
    NAME 'StockPivotImpl.ODCITableStart(oracle.sql.STRUCT[], java.sql.ResultSet)
return java.math.BigDecimal',

  MEMBER FUNCTION ODCITableFetch(self IN OUT StockPivotImpl, nrows IN NUMBER,
    outSet OUT TickerTypeSet) RETURN NUMBER
    AS LANGUAGE JAVA
    NAME 'StockPivotImpl.ODCITableFetch(java.math.BigDecimal, oracle.sql.ARRAY[])
return java.math.BigDecimal',

  MEMBER FUNCTION ODCITableClose(self IN StockPivotImpl) RETURN NUMBER
    AS LANGUAGE JAVA
    NAME 'StockPivotImpl.ODCITableClose() return java.math.BigDecimal'

);
/
show errors

```

## 17.2.2 Implementing the ODCITable Methods in Java

[Example 17-4](#) implements the three ODCITable methods as external functions in Java.

### Example 17-4 Implementing ODCITableXXX() Methods in Java

```

import java.io.*;
import java.util.*;
import oracle.sql.*;
import java.sql.*;
import java.math.BigDecimal;
import oracle.CartridgeServices.*;

// stored context type

public class StoredCtx
{
  ResultSet rset;
  public StoredCtx(ResultSet rs) { rset=rs; }
}

// implementation type

public class StockPivotImpl implements SQLData
{
  private BigDecimal key;

  final static BigDecimal SUCCESS = new BigDecimal(0);
  final static BigDecimal ERROR = new BigDecimal(1);

  // Implement SQLData interface.

  String sql_type;
  public String getSQLTypeName() throws SQLException
  {
    return sql_type;
  }
}

```

```

public void readSQL(SQLInput stream, String typeName) throws SQLException
{
    sql_type = typeName;
    key = stream.readBigDecimal();
}

public void writeSQL(SQLOutput stream) throws SQLException
{
    stream.writeBigDecimal(key);
}

// type methods implementing ODCITable interface

static public BigDecimal ODCITableStart(STRUCT[] sctx,ResultSet rset)
throws SQLException
{
    Connection conn = DriverManager.getConnection("jdbc:default:connection:");

    // create a stored context and store the result set in it
    StoredCtx ctx=new StoredCtx(rset);

    // register stored context with cartridge services
    int key;
    try {
        key = ContextManager.setContext(ctx);
    } catch (CountException ce) {
        return ERROR;
    }

    // create a StockPivotImpl instance and store the key in it
    Object[] impAttr = new Object[1];
    impAttr[0] = new BigDecimal(key);
    StructDescriptor sd = new StructDescriptor("STOCKPIVOTIMPL",conn);
    sctx[0] = new STRUCT(sd,conn,impAttr);

    return SUCCESS;
}

public BigDecimal ODCITableFetch(BigDecimal nrows, ARRAY[] outSet)
throws SQLException
{
    Connection conn = DriverManager.getConnection("jdbc:default:connection:");

    // retrieve stored context using the key
    StoredCtx ctx;
    try {
        ctx=(StoredCtx)ContextManager.getContext(key.intValue());
    } catch (InvalidKeyException ik ) {
        return ERROR;
    }

    // get the nrows parameter, but return up to 10 rows
    int nrowsval = nrows.intValue();
    if (nrowsval>10) nrowsval=10;

    // create a vector for the fetched rows
    Vector v = new Vector(nrowsval);
    int i=0;

    StructDescriptor outDesc =

```

```

        StructDescriptor.createDescriptor("TICKERTYPE", conn);
        Object[] out_attr = new Object[3];

        while(nrowsval>0 && ctx.rset.next()){
            out_attr[0] = (Object)ctx.rset.getString(1);
            out_attr[1] = (Object)new String("0");
            out_attr[2] = (Object)new BigDecimal(ctx.rset.getFloat(2));
            v.add((Object)new STRUCT(outDesc, conn, out_attr));

            out_attr[1] = (Object)new String("C");
            out_attr[2] = (Object)new BigDecimal(ctx.rset.getFloat(3));
            v.add((Object)new STRUCT(outDesc, conn, out_attr));

            i+=2;
            nrowsval-=2;
        }

        // return if no rows found
        if(i==0) return SUCCESS;

        // create the output ARRAY using the vector
        Object out_arr[] = v.toArray();
        ArrayDescriptor ad = new ArrayDescriptor("TICKERTYPESET",conn);
        outSet[0] = new ARRAY(ad,conn,out_arr);

        return SUCCESS;
    }

    public BigDecimal ODCITableClose() throws SQLException {

        // retrieve stored context using the key, and remove from ContextManager
        StoredCtx ctx;
        try {
            ctx=(StoredCtx)ContextManager.clearContext(key.intValue());
        } catch (InvalidKeyException ik ) {
            return ERROR;
        }

        // close the result set
        Statement stmt = ctx.rset.getStatement();
        ctx.rset.close();
        if(stmt!=null) stmt.close();

        return SUCCESS;
    }
}

```



# Part IV

## Reference

This part contains reference information on cartridge-related APIs.

- [Cartridge Services Using C\\_ C++ and Java](#)
- [Extensibility Constants\\_ Types\\_ and Mappings](#)
- [Extensible Indexing Interface](#)
- [Extensible Optimizer Interface](#)
- [User-Defined Aggregate Functions Interface](#)
- [Pipelined and Parallel Table Functions](#)

# 18

## Cartridge Services Using C, C++ and Java

Cartridge services are available to programmers using C/C++ and Java.



### See Also:

*Oracle Call Interface Programmer's Guide* for more details on cartridge services using C

### 18.1 OCI Access Functions for External Procedures

When called from an external procedure, a service routine can raise exceptions, allocate memory, and get OCI handles for callbacks to the server. To use the functions, you must specify the `WITH CONTEXT` clause, which lets you pass a context structure to the external procedure. The context structure is declared in header file `ociextp.h` as follows:

```
typedef struct OCIExtProcContext OCIExtProcContext;
```

Consider how service routines use context information. For more information and examples of usage, see *Oracle Database Advanced Application Developer's Guide*.

#### 18.1.1 OCIExtProcAllocCallMemory

This service routine allocates *n* bytes of memory for the duration of the external procedure call. Any memory allocated by the function is freed as soon as control returns to PL/SQL.

Do not use any other function to allocate or free memory.

The C prototype for this function follows:

```
void *OCIExtProcAllocCallMemory(  
    OCIExtProcContext *with_context,  
    size_t amount);
```

The parameters *with\_context* and *amount* are the context pointer and number of bytes to allocate, respectively. The function returns an untyped pointer to the allocated memory. A return value of zero indicates failure.

#### 18.1.2 OCIExtProcRaiseExcp

This service routine raises a predefined exception, which must have a valid Oracle error number in the range 1 to 32767. After doing any necessary cleanup, the external procedure must return immediately. (No values are assigned to `OUT` or `IN OUT` parameters.) The C prototype for this function follows:

```
int OCIExtProcRaiseExcp(
    OCIExtProcContext *with_context,
    size_t error_number);
```

The parameters *with\_context* and *error\_number* are the context pointer and Oracle error number. The return values `OCIEXTPROC_SUCCESS` and `OCIEXTPROC_ERROR` indicate success or failure.

### 18.1.3 OCIExtProcRaiseExcpWithMsg

This service routine raises a user-defined exception and returns a user-defined error message. The C prototype for this function follows:

```
int OCIExtProcRaiseExcpWithMsg(
    OCIExtProcContext *with_context,
    size_t error_number,
    text *error_message,
    size_t len);
```

The parameters *with\_context*, *error\_number*, and *error\_message* are the context pointer, Oracle error number, and error message text. The parameter *len* stores the length of the error message. If the message is a null-terminated string, *len* is zero. The return values `OCIEXTPROC_SUCCESS` and `OCIEXTPROC_ERROR` indicate success or failure.

### 18.1.4 OCIExtProcGetEnv

This service routine enables OCI callbacks to the database during an external procedure call. Use the OCI handles obtained by this function only for callbacks. If you use them for standard OCI calls, the handles establish a new connection to the database and cannot be used for callbacks in the same transaction. In other words, during an external procedure call, you can use OCI handles for callbacks or a new connection but not for both.

The C prototype for this function follows:

```
sword OCIExtProcGetEnv(
    OCIExtProcContext *with_context,
    OCIEnv **envh,
    OCISvcCtx **svch,
    OCIError **errh);
```

The parameter *with\_context* is the context pointer, and the parameters *envh*, *svch*, and *errh* are the OCI environment, service, and error handles, respectively. The return values `OCIEXTPROC_SUCCESS` and `OCIEXTPROC_ERROR` indicate success or failure.

"[Using Callbacks](#)" shows how `OCIExtProcGetEnv` might be used in callbacks. For a working example, see the script `extproc.sql` in the PL/SQL demo directory. (For the location of this directory, see your Oracle installation or user's guide.) This script demonstrates the calling of an external procedure. The companion file `extproc.c` contains the C source code for the external procedure. To run the demo, follow the instructions in `extproc.sql`. You must use an account that has `CREATE LIBRARY` privileges.

## 18.2 Installing Java Cartridge Services Files

The `ODCI.jar` and `CartridgeServices.jar` files must be installed into the `sys` schema to use the Java classes described here.

If you installed the Java option, then you must install the `ODCI.jar` and `CartridgeServices.jar` files. You do not have to perform this task if you did not install the Java option.

### To install `ODCI.jar` and `CartridgeServices.jar` files

1. Activate the SQL\*Plus prompt.

```
C:\sqlplus
```

2. When prompted, login using the `system` account.

```
Enter user-name: system
Enter password: password
```

3. Use the server-side `loadjava` command to install the classes and create the synonyms in the `SYSTEM` schema.

```
SQL> call dbms_java.loadjava('-resolve -synonym -grant public
-verbose vobs/jilip/Cartridge Services.jar');
SQL> call dbms_java.loadjava('-resolve -synonym -grant public
-verbose vobs/jlib/ODCI.jar');
```

See *Oracle Database Upgrade Guide* for further details on installing the `jar` files.

## 18.3 Cartridge Services-Maintaining Context

The Java cartridge service is used for maintaining context. It is similar to the OCI context management service. This class is necessary when switching context between the server and the cartridge code.

### 18.3.1 ContextManager

`ContextManager` is a Constructor in class `Oracle` that extends `Object`.

#### Class Interface

```
public static Hashtable ctx extends Object
```

#### Variable

```
ctx public static Hashtable ctx
```

#### Constructors

```
ContextManager public ContextManager()
```

#### Methods

The following methods are available:

```
setContext (static method in class oracle)
getContext (static method in class oracle)
clearContext (static method in class oracle)
```

### 18.3.2 CountException()

Constructor that extends `Exception`.

```
Class oracle.CartridgeServices.CountException
```

### 18.3.3 CountException(String)

Constructor that extends `Exception`.

```
public CountException(String s)
```

### 18.3.4 InvalidKeyException()

Constructor that extends `Exception`.

```
public InvalidKeyException(String s)
```

### 18.3.5 InvalidKeyException(String)

Constructor that extends `Exception`.

```
public InvalidKeyException(String s)
```

# 19

## Extensibility Constants, Types, and Mappings

System Defined Constants and System Defined Types apply generically to all supported languages, as well as mappings that are specific to the PL/SQL, C, and Java languages.

### 19.1 System Defined Constants

Consider the constants defined in the `ODCIConst` package installed as part of the `catodci.sql` script. There are equivalent definitions for use within C routines in `odci.h`. You should use these constants instead of hard coding their underlying values in your routines.

The system defined constants fall into two broad categories:

- Bit-field values that may be combined using the `OR` operator: [Table 19-3](#), [Table 19-4](#), [Table 19-5](#), [Table 19-6](#), [Table 19-7](#), [Table 19-8](#), [Table 19-9](#), [Table 19-10](#)
- Distinct values, where only one option may be specified: [Table 19-1](#), [Table 19-2](#), [Table 19-12](#), [Table 19-11](#)

#### 19.1.1 ODCIArgDesc.ArgType System Defined Constants

**Table 19-1 ODCIArgDesc.ArgType Values**

Name	Description
<code>ArgOther</code>	Argument is other expression
<code>ArgCol</code>	Argument is a column name
<code>ArgLit</code>	Argument is a literal value
<code>ArgAttr</code>	Argument is an ADT <code>attr</code> column
<code>ArgCursor</code>	Argument is a <code>CURSOR</code> expression
<code>ArgNull</code>	Argument is <code>NULL</code>

## 19.1.2 ODCIEnv.CallProperty System Defined Constants

**Table 19-2 ODCIEnv.CallProperty Values**

Name	Description
None	Default option
FirstCall	First partition call
Intermediate Call	Intermediate partition call
FinalCall	Final call after last partition
StatsGlobal	Used to specify global statistics gathering
StatsGlobalAndPartition	Used to specify global and partition-level statistics gathering
StatsPartition	Used to specify partition-level statistics gathering

## 19.1.3 ODCIIndexAlter System Defined Constants

**Table 19-3 ODCIIndexAlter Options**

Name	Description
AlterIndexNone	Default option
AlterIndexRename	Rename Partition option
AlterIndexRebuild	Rebuild Index option
AlterIndexUpdBlockRefs	IOT update block references
AlterIndexMigrate	Migrate user-managed domain index to a system-managed domain index.
AlterIndexRenameCol	Rename the column on which the domain index is based
AlterIndexRenameTab	Rename the table on which the domain index is based

## 19.1.4 ODCIIndexInfo.Flags System Defined Constants

**Table 19-4 ODCIIndexInfo.Flags Bits**

Name	Bits Value	Description
Local	CONSTANT INTEGER := 1;	Indicates a local domain index
Parallel	CONSTANT INTEGER := 16;	Indicates that a parallel degree was specified for the index creation or alter operation
Unusable	CONSTANT INTEGER := 32;	Indicates that UNUSABLE was specified during index creation, and that the index is marked unusable
IndexOnIOT	CONSTANT INTEGER := 64;	Indicates that the domain index is defined on an index-organized table
RangePartn	CONSTANT INTEGER := 2;	For a local domain index, indicates that the base table is range-partitioned. Is set only in conjunction with the Local bit
ListPartn	CONSTANT INTEGER := 512;	For a local domain index, indicates that the base table is list-partitioned. Is set only in conjunction with the Local bit.
HashPartn	CONSTANT INTEGER := 4;	For a local domain index, indicates that the base table is hash-partitioned. Is set only in conjunction with the Local bit
TransTblspc	CONSTANT INTEGER := 128;	Indicates that the domain index is created in a transportable tablespace session.
FunctionIdx	CONSTANT INTEGER := 256;	Indicates that the index is a function-based domain index
Online	CONSTANT INTEGER := 8;	Indicates an online domain index
UpdateGlobalIndexes	CONSTANT INTEGER := 1024;	Indicates that the index is an updated global domain index
RefPartn	CONSTANT INTEGER := 2048;	For a local domain index, indicates that the base table is reference-partitioned. Is set only in conjunction with the Local bit.
CompPartn	CONSTANT INTEGER := 8192;	For a local domain index, indicates that the base table is composite partitioned. Is set in conjunction with the Local bit and the RangePartn, ListPartn, or HashPartn bits.
SubPartn	CONSTANT INTEGER := 16384	For a local domain index, indicates that the partition information for the current call refers to a subpartition. Is set in conjunction with the CompPartn bit.



## 19.1.5 ODCIIPartInfo.PartOp System Defined Constants

**Table 19-5 Description of the ODCIIPartInfo.PartOp System Defined Constant**

Name	Description
AddPartition	The partition to be added
DropPartition	The partition to be dropped

## 19.1.6 ODCIIPredInfo.Flags System Defined Constants

**Table 19-6 ODCIIPredInfo.Flags Bits**

Name	Description
PredExactMatch	Equality predicate
PredPrefixMatch	LIKE predicate
PredIncludeStart	Include start value in index range scan
PredIncludeStop	Include stop value in index range scan
PredObjectFunc	Left hand side of predicate is a standalone function
PredObjectPkg	Left hand side of predicate is a package function
PredObjectType	Left hand site of predicate is a type method
PredMultiTable	Predicate contains columns from several tables
PredNotEqual	Inequality predicate

## 19.1.7 ODCIFuncInfo.Flags System Defined Constants

**Table 19-7 ODCIFuncInfo.Flags Bits**

Name	Description
ObjectFunc	Standalone function
ObjectPkg	Package function

**Table 19-7 (Cont.) ODCIFuncInfo.Flags Bits**

Name	Description
ObjectType	Type method

## 19.1.8 ODCIQueryInfo.Flags System Defined Constants

**Table 19-8 ODCIQueryInfo.Flags Bits**

Name	Description
QueryFirstRows	Optimizer mode is FIRST_ROWS
QueryAllRows	Optimizer mode is ALL_ROWS

## 19.1.9 ODCIStatsOptions.Flags System Defined Constants

**Table 19-9 ODCIStatsOptions.Flags Bits**

Name	Description
EstimateStats	Estimate statistics option
ComputeStats	Compute exact statistics option
Validate	Validate index option

## 19.1.10 ODCIStatsOptions.Options System Defined Constants

**Table 19-10 ODCIStatsOptions.Options Bits**

Name	Description
PercentOption	Compute statistics by sampling
RowOption	Compute statistics based on all rows

## 19.1.11 Return Status System Defined Constants

**Table 19-11 Return Status Values**

Name	Description
Success	Indicates a successful operation.
Error	Indicates an error.
Warning	Indicates a warning.
ErrContinue	Indicates that there is an error in an index partition, but continues to work on the next partition.
Fatal	Indicates that all dictionary entries of the index are cleaned up, and that the <code>CREATE INDEX</code> operation is rolled back

## 19.1.12 ScnFlg System Defined Constants

**Table 19-12 ScnFlg Values; Function with Index Context**

Name	Description
RegularCall	User defined operator regular call
CleanupCall	User defined operator cleanup call

## 19.2 System-Defined Types

Several system-defined types are defined by Oracle and must be created by running the `catodci.sql` catalog script. The C mappings for these object types are defined in `odci.h`. The `ODCIIndex` and `ODCIStats` routines described in [Extensible Indexing Interface](#) and [Extensible Optimizer Interface](#) use these types as parameters.

Unless otherwise mentioned, the names parsed as type attributes are unquoted identifiers.

### 19.2.1 ODCIArgDesc

Object type. Stores function or operator arguments.

**Table 19-13 ODCIArgDesc Function and Operator Argument Description - Attributes**

Name	Data Type	Description
ArgType	NUMBER	Argument type
TableName	VARCHAR2(30)	Name of table
TableSchema	VARCHAR2(30)	Schema containing the table
ColName	VARCHAR2(4000)	Name of column. This could be top level column name such as "A", or a nested column "A"."B" Note that the column name are quoted identifiers.
TablePartitionLower	VARCHAR2(30)	Contains the name of the lowest table partition that is accessed in the query
TablePartitionUpper	VARCHAR2(30)	Contains the name of the highest table partition that is accessed in the query
Cardinality	NUMBER	Cardinality value for CURSOR expressions

## 19.2.2 ODCIArgDescList

Contains a list of argument descriptors

### Data Type

VARRAY(32767) of ODCIArgDesc

## 19.2.3 ODCIRidList

Stores list of rowids. The rowids are stored in their character format.

### Data Type

VARRAY(32767) OF VARCHAR2("M\_URID\_SZ")

## 19.2.4 ODCICollInfo

Stores column related information.

### Data Type

Object type.

**Table 19-14 ODCIColInfo Column Related Information - Attributes**

Name	Data Type	Purpose
TableSchema	VARCHAR2(30)	Schema containing table
TableName	VARCHAR2(30)	Name of table
ColName	VARCHAR2(4000)	Name of column. This could be top level column name such as "A", or a nested column "A"."B" Note that the column name are quoted identifiers.
ColTypeName	VARCHAR2(30)	Data Type of column
ColTypeSchema	VARCHAR2(30)	Schema containing data type if user-defined data type
TablePartition	VARCHAR2(30)	For a local domain index, contains the name of the specific base table partition
TablePartitionIden	NUMBER	Base table partition physical identifier
TablePartitionTotal	NUMBER	Total number of partitions in a table

## 19.2.5 ODCIColInfoList

Stores information related to a list of columns.

### Data Type

VARRAY(32) OF ODCIColInfo

## 19.2.6 ODCICost

Object type. Stores cost information.

**Table 19-15 ODCICost Cost Information - Attributes**

Name	Data Type	Purpose
CPUCost	NUMBER	CPU cost
IOCost	NUMBER	I/O cost
NetworkCost	NUMBER	Communication cost
IndexCostInfo	VARCHAR2(255)	Optional user-supplied information about the domain index for display in the <code>PLAN</code> table (255 characters maximum)

## 19.2.7 ODCIEnv

Object type. Contains general information about the environment in which the extensibility routines are executing.

**Table 19-16 ODCIEnv Environment Variable Descriptor Information - Attributes**

Name	Data Type	Purpose
EnvFlags	NUMBER	<ul style="list-style-type: none"> <li>1 = Debugging On</li> <li>2 = NoData; used in ODCIIndexAlter() method with alter_option = AlterIndexRebuild to indicate that there is no data in the base partition. It is set only when ODCIIndexAlter() is used as part of TRUNCATE TABLE and partition management operations.</li> <li>4 = UserParamString; used in ODCIIndexAlter() method with alter_option = AlterIndexRebuild to indicate that the parameter string was specified by the user. It is set only when ODCIIndexAlter is invoked when rebuilding an index partition.</li> <li>8 = RowMigration; used in ODCIIndexInsert() and ODCIIndexDelete() to indicate that the respective call to these interfaces is done because an UPDATE operation caused the row to be migrated from one partition to another.</li> </ul>
CallProperty	NUMBER	<ul style="list-style-type: none"> <li>0 = None</li> <li>1 = First Call</li> <li>2 = Intermediate Call</li> <li>3 = Final Call</li> <li>6 = Global Statistics</li> <li>7 = Global and Partition Statistics</li> <li>8 = Partition Statistics</li> </ul>
DebugLevel	NUMBER	Indicates the level of debugging

### Usage Notes

CallProperty is used only for CREATE INDEX, DROP INDEX, TRUNCATE TABLE, and for some extensible optimizer-related calls. In all other cases, including DML and query routines for local domain indexes, it is set to 0.

## 19.2.8 ODCIFuncInfo

Object type. Stores functional information.

**Table 19-17 ODCIFuncInfo Function Information - Attributes**

Name	Data Type	Purpose
ObjectSchema	VARCHAR2(30)	Object schema name
ObjectName	VARCHAR2(30)	Function/package/type name

**Table 19-17 (Cont.) ODCIFuncInfo Function Information - Attributes**

Name	Data Type	Purpose
MethodName	VARCHAR2(30)	Method name for package/type
Flags	NUMBER	Function flags - see ODCIConst

## 19.2.9 ODCIIndexInfo

Object type. Stores the metadata information related to a domain index. It is passed as a parameter to all `ODCIIndex` routines.

**Table 19-18 ODCIIndexInfo Index Related Information - Attributes**

Name	Data Type	Purpose
IndexSchema	VARCHAR2(30)	Schema containing domain index
IndexName	VARCHAR2(30)	Name of domain index
IndexCols	ODCIColInfoList	List of indexed columns
IndexPartition	VARCHAR2(30)	For a local domain index, contains the name of the specific index partition
IndexInfoFlags	NUMBER	Possible flags are: <ul style="list-style-type: none"> <li>• Local</li> <li>• RangePartn</li> <li>• Parallel</li> <li>• Unusable</li> <li>• IndexOnIOT</li> <li>• ListPartn</li> <li>• TransTblspc</li> <li>• FunctionIdx</li> <li>• HashPartn</li> </ul>
IndexParaDegree	NUMBER	The degree of parallelism, if one is specified when creating or rebuilding a domain index or local domain index partition in parallel
IndexPartitionIden	NUMBER	The index partition object identifier, for local domain indexes
IndexPartitionTotal	NUMBER	The total number of partitions in an index

## 19.2.10 ODCIIndexCtx

Object type. Stores the index context, including the domain index metadata and the rowid. It is passed as parameter to the functional implementation of an operator that expects index context.

**Table 19-19 ODCIIndexCtx Index Context Related Information - Attributes**

Name	Data Type	Purpose
IndexInfo	ODCIIndexInfo	Stores the metadata information about the domain index
rid	VARCHAR2("M_URID_SZ")	Row identifier of the current row

## 19.2.11 ODCIObject

Object type. Stores information about a schema object.

**Table 19-20 ODCIObject Index Context Related Information - Attributes**

Name	Data Type	Purpose
ObjectSchema	VARCHAR2(30)	Name of schema in which object is located
ObjectName	VARCHAR2(30)	Name of object

## 19.2.12 ODCIObjectList

Stores information about a list of schema objects.

### Data Type

VARRAY(32) OF ODCIObject

## 19.2.13 ODCIPartInfo

Object type. Contains the names of both the table partition and the index partition.

**Table 19-21 ODCIPartInfo Index-Related Information - Attributes**

Name	Data Type	Purpose
TablePartition	VARCHAR2(30)	Table partition name
IndexPartition	VARCHAR2(30)	Index partition name
IndexPartitionIden	NUMBER	Index partition object identifier
PartOp	NUMBERER	Partition operation that is being performed



## 19.2.14 ODCIPartInfoList

Stores information related to a list of partitions.

### Data Type

VARRAY(64000) OF ODCIPartInfo

## 19.2.15 ODCIPredInfo

Object type. Stores the metadata information related to a predicate containing a user-defined operator or function. It is also passed as a parameter to the [ODCIIndexStart\(\)](#) query routine.

**Table 19-22 ODCIPredInfo Operator Related Information - Attributes**

Name	Data Type	Purpose
ObjectSchema	VARCHAR2(30)	Schema of operator/function
ObjectName	VARCHAR2(30)	Name of operator/function
MethodName	VARCHAR2(30)	Name of method, applies only to package methods type
Flags	NUMBER	Possible flags are: <ul style="list-style-type: none"> <li>• PredExactMatch - Exact Match</li> <li>• PredPrefixMatch - Prefix Match</li> <li>• PredIncludeStart - Bounds include the start key value</li> <li>• PredIncludeStop - Bounds include the stop key value</li> <li>• PredMultiTable - Predicate involves multiple tables</li> <li>• PredNotEqual - Predicate inequality</li> <li>• PredObjectFunc - Object is a function</li> <li>• PredObjectPkg - Object is a package</li> <li>• PredObjectType - Object is a type</li> </ul>

## 19.2.16 ODCIQueryInfo

Object type. Stores information about the context of a query. It is passed as a parameter to the [ODCIIndexStart\(\)](#) routine.

**Table 19-23 ODCIQueryInfo Index Context Related Information - Attributes**

Name	Data Type	Purpose
Flags	NUMBER	The following flags can be set: <ul style="list-style-type: none"> <li>QueryFirstRows - Set when the optimizer hint <code>FIRST_ROWS</code> is specified in the query</li> <li>QueryAllRows - Set when the optimizer hint <code>ALL_ROWS</code> is specified in the query</li> </ul>
AncOps	ODCICollectionList	Ancillary operators referenced in the query

## 19.2.17 ODCIStatsOptions

Object type. Stores options information for `DBMS_STATS`.

**Table 19-24 ODCIStatsOptions Cost Information - Attributes**

Name	Data Type	Purpose
Sample	NUMBER	Sample size
Options	NUMBER	<code>DBMS_STATS</code> options - see " <a href="#">ODCICost</a> "
Flags	NUMBER	<code>DBMS_STATS</code> flags - see " <a href="#">ODCICost</a> "

## 19.2.18 ODCITabFuncStats

Object type. Stores cardinality information for a table function.

**Table 19-25 ODCITabFuncStats Parameter**

Parameter	Data Type	Purpose
<code>num_rows</code>	NUMBER	Contains the number of rows expected to be returned by the table function

## 19.2.19 ODCITabStats

Stores table statistics for a table function.

### Data Type

NUMBER

**Table 19-26 ODCITabStats - Attributes**

Name	Data Type	Purpose
<code>Num_rows</code>	NUMBER	Number of rows in table

## 19.2.20 ODCIBFileList

Stores `varrayS` of `BFILES`.

### Data Type

`VARRAY(32767) OF BFILE`

## 19.2.21 ODCITabFuncInfo

Object type. Stores information on which attributes of user-defined types in a collection must be set by a table function.

**Table 19-27 ODCITabFuncInfo Parameters**

Name	Data Type	Purpose
<code>Attrs</code>	<code>ODCINumberList</code>	Indicates the attributes that must be set
<code>RetType</code>	<code>AnyType</code>	For <code>AnyDataSet</code> table functions, indicates the actual return type to be expected in the <code>AnyDataSet</code> collection

## 19.2.22 ODCIDateList

Stores `varrayS` of `DATES`.

### Data Type

`VARRAY(32767) OF DATE`

## 19.2.23 ODCINumberList

Stores `varrayS` of `NUMBERS`.

### Data Type

`VARRAY(32767) OF NUMBER`

## 19.2.24 ODCIRawList

Stores `varrayS` of `RawS`.

### Data Type

`VARRAY(32767) OF Raw(2000)`

## 19.2.25 ODCIVarchar2List

Stores `varrayS` of `VARCHAR2S`

### Data Type

`VARRAY(32767) OF VARCHAR2(4000)`

## 19.2.26 ODCIFuncCallInfo

Object type. Stores information about the functional implementation of an operator.

**Table 19-28 ODCIFuncCallInfo - Attributes**

Name	Data Type	Purpose
ColInfo	ODCIColInfo	Information about the column on which the operator is invoked

### Usage Notes

A functional implementation can be defined with this parameter only if the operator binding is declared `WITH COLUMN CONTEXT`. This is useful if the functional implementation requires information about the column it was invoked on, and there is no domain index defined on the column. This argument is only populated in the function invocation if the first argument of the operator invocation is a column and there is no domain index defined on that column.

## 19.3 Mappings of Constants and Types

Consider language-specific constant and type mappings.

### 19.3.1 Mappings in PL/SQL

A variety of PL/SQL mappings are common to both Extensible Indexing and the Extensible Optimizer.

- Constants are defined in the `ODCIConst` package found in `catodci.sql`
- Types are defined as object types found in `catodci.sql`

### 19.3.2 Mappings in C

Mappings of constants and types are defined for C in the public header file `odci.h`. Each C structure to which a type is mapped has a corresponding indicator structure called `structname_ind` and a reference definition called `structname_ref`.

# 20

## Extensible Indexing Interface

Various Oracle Data Cartridge Interface extensible indexing parameters are described.

### 20.1 Extensible Indexing - System-Defined Interface Routines

Table 20-1 summarizes the extensible indexing routines.

**▲ Caution:**

These routines are invoked by Oracle at the appropriate times based on SQL statements executed by the end user. Do not invoke these routines directly as this may result in corruption of index data.

**Table 20-1 Summary of System-Defined Extensible Indexing Interface Routines**

Routine	Description
<a href="#">ODCIGetInterfaces()</a>	Invoked when an <code>INDEXTYPE</code> is created by a <code>CREATE INDEXTYPE . . .</code> statement or is altered.
<a href="#">ODCIIndexAlter()</a>	Invoked when a domain index or a domain index partition is altered using an <code>ALTER INDEX</code> , an <code>ALTER INDEX PARTITION</code> , a <code>TRUNCATE TABLE</code> , a <code>RENAME TABLE</code> , an <code>ALTER TABLE RENAME COLUMN</code> , or an <code>ALTER TABLE [ADD TRUNCATE SPLIT MERGE] PARTITION</code> statement.
<a href="#">ODCIIndexClose()</a>	Invoked to end the processing of an operator.
<a href="#">ODCIIndexCreate()</a>	Invoked when a domain index is created by a <code>CREATE INDEX . . . INDEXTYPE IS . . . PARAMETERS . . .</code> statement issued by the user.
<a href="#">ODCIIndexDelete()</a>	Invoked when a row is deleted from a table that has a domain index defined on one or more of its columns.
<a href="#">ODCIIndexDrop()</a>	Invoked when a domain index is dropped explicitly using a <code>DROP INDEX</code> statement, or implicitly through a <code>DROP TABLE</code> or <code>DROP USER</code> statement.
<a href="#">ODCIIndexExchangePartition()</a>	Invoked when an <code>ALTER TABLE EXCHANGE PARTITION . . . INCLUDING INDEXES</code> is issued on a partitioned table on which a local domain index is defined.
<a href="#">ODCIIndexFetch()</a>	Invoked repeatedly to retrieve the rows satisfying the operator predicate.
<a href="#">ODCIIndexGetMetadata()</a>	Returns a series of strings of PL/SQL code that comprise the non-dictionary metadata associated with the index.

**Table 20-1 (Cont.) Summary of System-Defined Extensible Indexing Interface Routines**

Routine	Description
<a href="#">ODCIIndexInsert()</a>	Invoked when a row or a set of rows is inserted into a table that has a domain index defined on one or more of its columns.
<a href="#">ODCIIndexStart()</a>	Invoked to start the evaluation of an operator on an indexed column.
<a href="#">ODCIIndexUpdate()</a>	Invoked when a row is updated in a table and the updated column has a domain index defined on.
<a href="#">ODCIIndexUpdPartMetadata()</a>	Invoked during partition maintenance operations. Patches the indextype metadata tables to correctly reflect the partition maintenance operation.
<a href="#">ODCIIndexUtilCleanup()</a>	Cleans up temporary states created by <a href="#">ODCIIndexUtilGetTableNames()</a> .
<a href="#">ODCIIndexUtilGetTableNames()</a>	Determines if the secondary tables storing the index data should be transported.

### 20.1.1 ODCIGetInterfaces()

Invoked when an `INDEXTYPE` is created by a `CREATE INDEXTYPE...` statement or is altered.

#### Syntax

```
FUNCTION ODCIGetInterfaces(
    ifclist OUT ODCIObjectList)
RETURN NUMBER
```

Parameter	Description
<code>ifclist</code>	Contains information about the interfaces it supports

#### Returns

`ODCIConst.Success` ON SUCCESS OR `ODCIConst.Error` ON ERROR

#### Usage Notes

This function should be implemented as a static type method.

This function must return `SYS.ODCIINDEX2` in the `ODCIObjectList` if the indextype uses the second version of the `ODCIIndex` interface.

### 20.1.2 ODCIIndexAlter()

Invoked when a domain index or a domain index partition is altered using one of the following methods:

- `ALTER INDEX`
- `ALTER INDEX PARTITION`

- TRUNCATE TABLE *table\_name*
- RENAME TABLE
- ALTER TABLE...[ADD|TRUNCATE|SPLIT|MERGE]...PARTITION
- ALTER TABLE RENAME
- ALTER TABLE RENAME COLUMN

To populate the index partitions when creating local domain indexes, this method is invoked for each partition of the base table.

### Syntax

```

STATIC FUNCTION ODCIIndexAlter(
    ia ODCIIndexInfo,
    parms IN OUT VARCHAR2,
    alter_option NUMBER,
    env ODCIEnv)
RETURN NUMBER

```

Parameter	Description
ia	Contains information about the index and the indexed column
parms (IN)	Parameter string <ul style="list-style-type: none"> <li>• With ALTER INDEX PARAMETERS or ALTER INDEX REBUILD, contains the user specified parameter string</li> <li>• With ALTER INDEX RENAME, contains the new name of the domain index</li> <li>• With ALTER TABLE RENAME COLUMN, contains the new domain-indexed column name</li> <li>• With ALTER TABLE RENAME or RENAME TABLE, contains the new table name</li> </ul>
parms (OUT)	Parameter string Valid only with ALTER INDEX PARAMETERS or ALTER INDEX REBUILD; contains the resultant string to be stored in system catalogs
alter_option	Specifies one of the following options: <ul style="list-style-type: none"> <li>• AlterIndexNone if ALTER INDEX [PARTITION] PARAMETERS</li> <li>• AlterIndexRename if ALTER INDEX RENAME [PARTITION]</li> <li>• AlterIndexRebuild if ALTER INDEX REBUILD [PARTITION] [PARAMETERS]</li> <li>• AlterIndexRenameCol if ALTER TABLE RENAME COLUMN</li> <li>• AlterIndexRenameTab if ALTER TABLE RENAME or RENAME TABLE</li> <li>• AlterIndexUpdBlockRefs if ALTER TABLE UPDATE BLOCK REFERENCES</li> <li>• AlterIndexMigrate if ALTER INDEX COMPILE when the domain index is user-managed, but its indextype is system-managed</li> </ul>
env	The environment handle passed to the routine

### Returns

ODCIConst.Success on success, ODCIConst.Error on error, or ODCIConst.Warning otherwise. When invoked to rebuild local index partitions, may also return ODCIConst.ErrContinue.

## Usage Notes

- This function should be implemented as a static type method.
- An `ALTER INDEX` statement can be invoked for domain indexes in multiple ways.

```
ALTER INDEX index_name
PARAMETERS (parms);
```

or

```
ALTER INDEX index_name
REBUILD PARAMETERS (parms);
```

The precise behavior in these two cases is defined by the implementation. One possibility is that the first statement would merely reorganize the index based on the parameters while the second would rebuild it from scratch.

- The maximum length of the input parameters string is 1000 characters. The `OUT` value of the `parms` argument can be set to resultant parameters string to be stored in the system catalogs.
- The `ALTER INDEX` statement can also be used to rename a domain index in the following way:

```
ALTER INDEX index_name
RENAME TO new_index_name
```

- When the name of the table on which a domain index is created changes, `ODCIIndexAlter()` is invoked with `alter_option=AlterIndexRenameTab`, and `new_table_name` is passed to the `parms` argument:

```
ALTER TABLE table_name
RENAME new_table_name
```

or

```
RENAME table_name
TO new_table_name
```

- When the name of the column on which a domain index is created changes, `ODCIIndexAlter()` is invoked with `alter_option=AlterIndexRenameCol`, and `new_column_name` is passed to the `parms` argument:

```
ALTER TABLE table_name
RENAME COLUMN column_name
TO new_column_name
```

- If the `PARALLEL` clause is omitted, then the domain index or local domain index partition is rebuilt sequentially.
- If the `PARALLEL` clause is specified, the parallel degree is passed to the `ODCIIndexAlter()` invocation in the `IndexParaDegree` attribute of `ODCIIndexInfo`, and the `Parallel` bit of the `IndexInfoFlags` attribute is set. The parallel degree is determined as follows:
  - If `PARALLEL DEGREE deg` is specified, `deg` is passed.
  - If only `PARALLEL` is specified, then a constant is passed to indicate that the default degree of parallelism was specified.
- If the `ODCIIndexAlter` routine returns with the `ODCIConst.Success`, the index is valid and usable. If the `ODCIIndexAlter()` routine returns with `ODCIConst.Warning`, the



index is valid and usable but a warning message is returned to the user. If `ODCIIndexAlter()` returns with an error (or exception), the domain index is marked `FAILED`.

- When the `ODCIIndexAlter()` routine is being executed, the domain index is marked `LOADING`.
- Every SQL statement executed by `ODCIIndexAlter()` is treated as an independent operation. The changes made by `ODCIIndexCreate()` are not guaranteed to be atomic.
- The `AlterIndexUpdBlockRefs` alter option applies only to domain indexes on index-organized tables. When the end user executes an `ALTER INDEX domain_index UPDATE BLOCK REFERENCES`, `ODCIIndexAlter()` is called with the `AlterIndexUpdBlockRefs` bit set to give the cartridge developer the opportunity to update guesses as to the block locations of rows, stored in logical rowids.
- The `AlterIndexMigrate` alter options applies only to migration of user-managed domain indexes to system-managed domain indexes. When the user-managed domain index is marked `INVALID`, but its `indextype` is system-managed, you must make an `ALTER INDEX domain_index COMPILE` call to re-validate the domain index. This calls the `ODCIIndexAlter()` method with `alter_option=AlterIndexMigrate`, to allow an opportunity to migrate the domain index to the system-managed approach.



#### See Also:

- [ODCIIndexAlter\(\)](#)
- [ODCIIndexCreate\(\)](#)

## 20.1.3 ODCIIndexClose()

Invoked to end the processing of an operator.

### Syntax

```
FUNCTION ODCIIndexClose(
    self IN impltype,
    env ODCIEnv)
RETURN NUMBER
```

Parameter	Description
<code>self (IN)</code>	Is the value of the context returned by the previous invocation of <a href="#">ODCIIndexFetch()</a>
<code>env</code>	The environment handle passed to the routine

### Returns

- `ODCIConst.Success` on success
- `ODCIConst.Error` on error

## Usage Notes

The index implementor can perform any appropriate actions to finish up the processing of an domain index scan, such as freeing memory and other resources.

## 20.1.4 ODCIIndexCreate()

Invoked when a domain index is created by a `CREATE INDEX...INDEXTYPE IS...PARAMETERS...` statement issued by the user. The domain index can be either a non-partitioned index or a local partitioned domain index. The local partitioned domain index can be created in either a system- or a user-managed scheme.

### Syntax

```
FUNCTION ODCIIndexCreate(
    ia ODCIIndexInfo,
    parms VARCHAR2,
    env ODCIEnv)
RETURN NUMBER
```

Parameter	Description
ia	Contains information about the index and the indexed column
parms	The <code>PARAMETERS</code> string passed in not interpreted by Oracle. The maximum size of the parameter string is 1,000 characters.
env	The environment handle passed to the routine

### Returns

`ODCIConst.Success`, `ODCIConst.Error`, `ODCIConst.Warning`, `ODCIConst.ErrContinue` if the method is invoked at the partition level for creation of a local partitioned index, to continue to the next partition even in case of an error, or `ODCIConst.Fatal` to signify that all dictionary entries for the index are cleaned up and that the `CREATE INDEX` operation is rolled back. Returning this status code assumes that the cartridge code has not created any objects (or cleaned up any objects created).

### Usage Notes

- This function should be implemented as a `STATIC` type method.
- Creates objects (such as tables) to store the index data, generate the index data, and store the data in the index data tables.
- This procedure should handle creation of indexes on both empty and non-empty tables. If the base table is not empty, the procedure can scan the entire table and generate index data.
- When the `ODCIIndexCreate()` routine is running, the domain index is marked `LOADING`.
- Every SQL statement executed by `ODCIIndexCreate()` is treated as an independent operation. The changes made by `ODCIIndexCreate()` are not guaranteed to be atomic.

- To create a non-partitioned domain index, the `ODCIIndexCreate()` method is invoked, and the only valid return codes are `ODCIConst.Success`, `ODCIConst.Warning`, `ODCIConst.Error`, or `ODCIConst.Fatal`. If the operation returns `ODCIConst.Fatal`, the `CREATE INDEX` statement is rolled back by the server.
- In a non-partitioned domain index, the `IndexPartition`, `TablePartition` name, and the `callProperty` should be `NULL`.
- For a non-partitioned domain index, the parallel degree is passed to the `ODCIIndexCreate()` invocation in the `IndexParaDegree` attribute of `ODCIIndexInfo`, and the `Parallel` bit of the `IndexInfoFlags` is set. The parallel degree is determined as follows:
  - If `PARALLEL DEGREE deg` is specified, `deg` is passed.
  - If only `PARALLEL` is specified, then a constant indicating that the default degree of parallelism was specified, is passed.
  - If the `PARALLEL` clause is omitted entirely, the operation is performed sequentially.
- If the `ODCIIndexCreate()` routine returns with the `ODCIConst.Success`, the index is valid and usable. If the `ODCIIndexCreate()` routine returns with `ODCIConst.Warning`, the index is valid and usable but a warning message is returned to the user. If the `ODCIIndexCreate()` routine returns with an `ODCIConst.Error` (or exception), the domain index is marked `FAILED`.
- The only operations permitted on `FAILED` domain indexes is `DROP INDEX`, `TRUNCATE TABLE` or `ALTER INDEX REBUILD`.
- If a domain index is created on an column of object type which contains a `REF` attribute, do not dereference the `REFS` while building your index. Dereferencing a `REF` fetches data from a different table instance. If the data in the other table is modified, the domain index becomes incorrect. Note that the user is not notified.
- The `ODCIIndexCreate()` method is invoked twice for the creation of system managed local domain indexes and the only valid return codes are `ODCIConst.Success`, `ODCIConst.Warning` or `ODCIConst.Error`. `ODCIConst.Fatal` can be returned by the first call and results in the `CREATE INDEX` statement being rolled back by the server. The number of partitions is passed in as an argument `ODCIIndexInfo.IndexPartitionTotal`. The first call should create all the index storage tables. All the index storage tables should preferably be system partitioned to get the benefits of local domain indexes. Also:
  - These tables must have the same number of partitions as the base table. If the base table is composite partitioned, then the domain index storage table should have the same number of total subpartitions as the base table.
  - The users should generate the create table statement with both object and partition level attributes.
- Note that the object level create routine only passes in the object level parameter string. However, to construct the storage attributes for all the partitions, it needs the partition level parameter strings. The cartridge indexing code must obtain them by querying the `*_ind_partitions` views on the dictionary tables. The system partitioned tables should not be populated in this phase. The user should wait for the subsequent calls `ODCIIndexAlter()` to populate the partitions. Also, it is recommended that the users should derive the names of the storage tables and its partitions from the index name and the index partition names. In this case, the user should fetch the index partition names from the `*_ind_partitions` view and construct the partition names for the storage table.

- In the second `ODCIIndexCreate()` call, the user can create domain index storage table dependent objects, such as indexes, constraints, and triggers. These can be created as before by directly using the SQL callbacks. However, for system partitioned storage tables, the following types of indexes are disallowed:
  - non-partitioned index
  - globally partitioned index
- Sequence numbers and synonyms can be created using callbacks and they are assumed to be partition-independent. The set of objects created for non-partitioned domain index is identical to that of a local partitioned index and these objects are not impacted when a table or partition maintenance operation is done. It is the users responsibility to drop these objects when the index is dropped.
- Other (transient) objects needed for temporary use can be created using callbacks as before. It is the responsibility of user-supplied code to drop them by the end of the create call.
- Temporary tables can be created for holding intermediate data. The server does not perform maintenance operations on these tables.
- External Objects, such as files, can be created for temporary use.
- All the tables left after the invocation of `ODCIIndexCreate()` or `ODCIIndexAlter()` are supposed to be system-managed, and the server takes appropriate actions on them during drop, truncate, or the partition maintenance operations.
- Since this routine handles multiple things, such as creation of a non-partitioned index or creation of a local index, you must take special care to code it appropriately.



**See Also:**

- [ODCIIndexAlter\(\)](#)
- [ODCIIndexCreate\(\)](#)

## 20.1.5 ODCIIndexDelete()

Invoked when a row is deleted from a table that has a domain index defined on one or more of its columns.

**Syntax**

```
FUNCTION ODCIIndexDelete(
    ia ODCIIndexInfo,
    rid VARCHAR2,
    oldval icoltype,
    env ODCIEnv)
RETURN NUMBER
```

Parameter	Description
ia	Contains information about the index and the indexed column

Parameter	Description
rid	The row identifier of the deleted row
oldval	The value of the indexed column in the deleted row. The data type is identical to that of the indexed column.
env	The environment handle passed to the routine

### Returns

ODCIConst.Success **ON SUCCESS**, or ODCIConst.Error **ON ERROR**.

### Usage Notes

- This function should be implemented as a `STATIC` type method.
- This method should delete index data corresponding to the deleted row from the appropriate tables or files storing index data.
- Note that the index partition object identifier `ODCIIndexInfo.IndexPartitionIden` and the base table partition physical identifier `ODCIIndexInfo.IndexCols(1).TablePartitionIden` is passed in for local domain index. The indextype must use the new DML syntax using the partition number and the provided `DATAOBJ_TO_MAT_PARTITION` function to delete data from the storage system partitioned table:

```
DELETE FROM SP PARTITION (
  DATAOBJ_TO_MAT_PARTITION(
    base_table_name,
    :tab_physical_partid))
VALUES(...)
WHERE rowid = :rowid;
```

## 20.1.6 ODCIIndexDrop()

The `ODCIIndexDrop()` procedure is invoked when a domain index is dropped explicitly using a `DROP INDEX` statement, or implicitly through a `DROP TABLE` or `DROP USER` statement.

### Syntax

```
FUNCTION ODCIIndexDrop(
  ia ODCIIndexInfo,
  env ODCIEnv)
RETURN NUMBER
```

Parameter	Description
ia	Contains information about the index and the indexed column
env	The environment handle passed to the routine

### Returns

ODCIConst.Success **ON SUCCESS**, or ODCIConst.Error **ON ERROR**, or ODCIConst.Warning.

### Usage Notes

- This method should be implemented as a static type method.
- This method should drop the tables storing the domain index data.
- For both a non-partitioned domain index and system managed local domain index, the `ODCIIndexDrop()` method is invoked only one time. The user need not drop the index storage tables if the system-managed approach is used. This is done automatically by the kernel after the call is completed.
- Since it is possible that the domain index is marked `FAILED` (due to abnormal termination of some DDL routine), the `ODCIIndexDrop()` routine should be capable of cleaning up partially created domain indexes. When the `ODCIIndexDrop()` routine is being executed, the domain index is marked `LOADING`.
- Note that if the `ODCIIndexDrop()` routine returns with an `ODCIConst.Error` or exception, the `DROP INDEX` statement fails and the index is marked `FAILED`. In that case, there is no mechanism to get rid of the domain index except by using the `FORCE` option. If the `ODCIIndexDrop()` routine returns with `ODCIConst.Warning` in the case of an explicit `DROP INDEX` statement, the operation succeeds but a warning message is returned to the user.
- Every SQL statement executed by `ODCIIndexDrop()` is treated as an independent operation. The changes made by `ODCIIndexDrop()` are not guaranteed to be atomic.
- For both a non-partitioned domain index and system managed local domain index, the `ODCIIndexDrop()` method is invoked only one time. With the system-managed approach, the index storage tables don't have to be dropped. This is done automatically by the kernel after the call is completed.



#### See Also:

[ODCIIndexDrop\(\)](#)

## 20.1.7 ODCIIndexExchangePartition()

This method is invoked when an `ALTER TABLE EXCHANGE PARTITION...INCLUDING INDEXES` command is issued on a partitioned table that has a defined local domain index.

### Syntax

```
FUNCTION ODCIIndexExchangePartition(
    ia ODCIIndexInfo,
    ia1 ODCIIndexInfo,
    env ODCIEnv)
RETURN NUMBER
```

Parameter	Description
<code>ia</code>	Contains information about the domain index partition to exchange.
<code>ia1</code>	Contains information about the non-partitioned domain index.
<code>env</code>	The environment handle passed to the routine

**Returns**

ODCIConst.Success **ON SUCCESS**, or ODCIConst.Error **ON ERROR**, or ODCIConst.Warning.

**Usage Notes**

- The function should be implemented as a `STATIC` type method.
- This method should handle both converting a partition of a domain index into a non-partitioned domain index and converting a non-partitioned index to a partition of a partitioned domain index.
- When exchanging composite partitions of a composite partitioned table, a call is made to `ODCIIndexExchangePartition` for each subpartition of the partition to exchange.

## 20.1.8 ODCIIndexFetch()

This procedure is invoked repeatedly to retrieve the rows satisfying the operator predicate.

**Syntax**

```
FUNCTION ODCIIndexFetch(
    self IN [OUT] impltype,
    nrows IN NUMBER,
    rids OUT ODCIRidList,
    env ODCIEnv)
RETURN NUMBER
```

Parameter	Description
self(IN)	Is the value of the context returned by the previous call (to <code>ODCIIndexFetch</code> or to <code>ODCIIndexStart()</code> if this is the first time fetch is being called for this operator instance
self(OUT)	The context that is passed to the next query-time call. Note that this parameter does not have to be defined as <code>OUT</code> if the value is not modified in this routine.
nrows	Is the maximum number of result rows that can be returned to Oracle in this call
rids	Is the array of row identifiers for the result rows being returned by this call
env	The environment handle passed to the routine

**Returns**

ODCIConst.Success **ON SUCCESS**, or ODCIConst.Error **ON ERROR**.

**Usage Notes**

- `ODCIIndexFetch()` returns rows satisfying the operator predicate. That is, it returns the row identifiers of all the rows for which the operator return value falls within the specified bounds.

- Each call to `ODCIIndexFetch()` can return a maximum of *nrows* number of rows. The value of *nrows* passed in is decided by Oracle based on some internal factors. However, the `ODCIIndexFetch()` routine can return lesser than *nrows* number of rows. The row identifiers are returned through the output *rids* array. A `NULL ROWID` (as an element of the *rids* array) indicates that all satisfying rows have been returned.

Assume that there are 3000 rows which satisfy the operator predicate, and that the value of `nrows = 2000`. The first invocation of `ODCIIndexFetch()` can return the first 2000 rows. The second invocation can return a *rid* list consisting of the remaining 1000 rows followed by a `NULL` element. The `NULL` value in *rid* list indicates that all satisfying rows have now been returned.

- If the context value is changed within this call, the new value is passed in to subsequent query-time calls.



#### See Also:

- [ODCIIndexFetch\(\)](#)
- [ODCIIndexStart\(\)](#)

## 20.1.9 ODCIIndexGetMetadata()

Returns a series of strings of PL/SQL code that comprise the non-dictionary metadata associated with the index in *ia*. The routine can pass whatever information is required at import time. For example, policy, version, preferences, and so on. This method is optional unless implementation-specific metadata is required.

### Syntax

```
FUNCTION ODCIIndexGetMetadata(
    ia IN ODCIIndexInfo,
    version IN VARCHAR2,
    new_block OUT PLS_INTEGER,
    env ODCIEnv)
RETURN VARCHAR2;
```

Parameter	Description
<i>ia</i>	Specifies the index on which export is currently working
<i>version</i>	Version of export making the call in the form 11.2.0.1.00
<i>new_block</i>	Non-zero ( <code>TRUE</code> ): Returned string starts a new PL/SQL block. Export terminates the current block (if any) with <code>END</code> ; and open a new block with <code>BEGIN</code> before writing strings to the dump file. The routine is called again. 0 ( <code>FALSE</code> ): Returned string continues current block. Export writes only the returned string to the dump file then calls the routine again.
<i>env</i>	The environment handle passed to the routine



## Returns

- A null-terminated string containing a piece of an opaque block of PL/SQL code
- A zero-length string indicates no more data; export stops calling the routine

## Usage Notes

- This function should be implemented as a static type method.
- The routine is called repeatedly until the return string length is 0. If an index has no metadata to be exported using PL/SQL, it should return an empty string upon first call.
- This routine can be used to build one or more blocks of anonymous PL/SQL code for execution by import. Each returned block is invoked independently by import. That is, if a block fails for any reason at import time, subsequent blocks are still invoked. Therefore any dependent code should be incorporated within a single block. The size of an individual block of PL/SQL code is limited only by the size of import's read buffer controlled by its `BUFFER` parameter.
- The execution of these PL/SQL blocks at import time is considered part of the associated domain index's creation. Therefore, their execution is dependent upon the successful import of the index's underlying base table and user's setting of import's `INDEXES=Y/N` parameter, as is the creation of the index.
- The routine should not pass back the `BEGIN/END` strings that open and close the individual blocks of PL/SQL code; export adds these to mark the individual units of execution.
- The parameter `version` is the version number of the currently executing export client. Since export and import can be used to downgrade a database to the previous functional point release, it also represents the minimum server version you can expect to find at import time; it may be higher, but never lower.
- The cartridge developer can use this information to determine what version of information should be written to the dump file. For example, assume the current server version is 11.2.0.1.0, but the export version handed in is 11.1.0.1.0. If a cartridge's metadata changed formats these version, it would know to write the data to the dump file in 11.1 format, anticipating an import into an 11.2 system.
- The data contained within the strings handed back to export must be completely platform-independent. That is, they should contain no binary information that may reflect the endian nature of the export platform, which may be different from the import platform. Binary information may be passed as hex strings and converted through `RAWTOHEX` and `HEXTORAW`.
- The strings are translated from the export server to export client character set and are written to the dump file as such. At import time, they are translated from export client character set to import client character set, then from import client char set to import server character set when handed over the UPI interface.
- Specifying a target schema in the execution of any of the PL/SQL blocks must be avoided because it frequently causes an error if you use import's `FROMUSER -> TOUSER` schema replication feature. For example, a procedure prototype such as:

```
PROCEDURE AQ_CREATE ( schema IN VARCHAR2, que_name IN VARCHAR2) ...
```

should be avoided because it fails if you have remapped schema A to schema B on import. You can assume at import time that you are connected to the target schema.

- Export dump files from a particular version must be importable into all future versions. This means that all PL/SQL routines invoked within the anonymous PL/SQL blocks written to the dump file must be supported for all time. You may wish to encode some version information to assist with detecting when conversion may be required.
- Export operates in a read-only transaction if its parameter `CONSISTENT=Y`. In this case, no writes are allowed from the export session. Therefore, this method must not write any database state.
- You can attempt to import the same dump file multiple times, especially when using import's `IGNORE=Y` parameter. Therefore, this method must produce PL/SQL code that is idempotent, or at least deterministic when executed multiple times.
- Case on database object names must be preserved; that is, objects named 'Foo' and 'FOO' are distinct objects. Database object names should be enclosed within double quotes ("" ) to preserve case.

### Error Handling

Any unrecoverable error should raise an exception allowing it to propagate back to `get_domain_index_metadata` and thence back to export. This causes export to terminate the creation of the current index's DDL in the dump file and to move on to the next index.

At import time, failure of the execution of any metadata PL/SQL block causes the associated index not to be created under the assumption that the metadata creation is an integral part of the index creation.

## 20.1.10 ODCIIndexInsert()

Invoked when a row or a set of rows is inserted into a table that has a domain index defined on one or more of its columns.

Syntax	Description
<pre>FUNCTION ODCIIndexInsert(     ia ODCIIndexInfo,     rid VARCHAR2,     newval icoltype,     env ODCIEnv) RETURN NUMBER</pre>	Inserts a single row
<pre>FUNCTION ODCIIndexInsert(     ia ODCIIndexInfo,     ridlist ODCIRidList,     newvallist varray_of_column_type,     env ODCIEnv) RETURN NUMBER</pre>	Inserts a set of rows

Parameter	Description
ia	Contains information about the index and the indexed column
rid	The row identifier of the new row in the table
newval	The value of the indexed column in the inserted row
ridlist	A varray (maximum size 32767) containing the list of rowids for the rows being inserted into the base table
newvallist	A varray (maximum size 32767) containing the list of values being inserted into the indexed column in the base table; these entries have a one-to-one correspondence with the entries in <code>ridlist</code>
env	The environment handle passed to the routine

### Returns

ODCIConst.Success ON SUCCESS, or ODCIConst.Error ON error.

### Usage Notes

- This function should be implemented as a `STATIC` type method.
- This method should insert index data corresponding to the row or set of rows passed in into the appropriate tables or files storing index data. A `NULL` value in `ridlist` indicates the end of the varray.
- If the indextype is defined `WITH ARRAY DML`, a batch of rows can be inserted into the table. In this case, `ODCIIndexInsert()` is invoked using the second of the two syntax synopses. Otherwise, the single-row syntax is used.
- Note that the index partition object identifier `ODCIIndexInfo.IndexPartitionIden` and the base table partition physical identifier `ODCIIndexInfo.IndexCols(1).TablePartitionIden` is passed in for local domain index. The indextype must use the new DML syntax using the partition number and the provided `DATAOBJ_TO_MAT_PARTITION` function to insert into the storage system partitioned table:

```
INSERT INTO SP PARTITION (
  DATAOBJ_TO_MAT_PARTITION(
    base_table_name,
    :tab_physical_partid))
VALUES(...);
```

## 20.1.11 ODCIIndexStart()

Invoked to start the evaluation of an operator on an indexed column.

### Syntax

```
FUNCTION ODCIIndexStart(
  sctx IN OUT <impltype>,
  ia ODCIIndexInfo,
  pi ODCIPredInfo,
```

```

    qi ODCIQueryInfo,
    strt <opbndtype>,
    stop <opbndtype>,
    <valargs>,
    env ODCIEnv)
RETURN NUMBER

```

Parameter	Description
sctx(IN)	The value of the scan context returned by some previous related query-time call (such as the corresponding ancillary operator, if invoked before the primary operator); NULL otherwise
sctx(OUT)	The context that is passed to the next query-time call; the next query-time call is to <code>ODCIIndexFetch()</code>
ia	Contains information about the index and the indexed column
pi	Contains information about the operator predicate
qi	Contains query information (hints plus list of ancillary operators referenced)
strt	The start value of the bounds on the operator return value. The data type is identical to that of the operator's return value
stop	The stop value of the bounds on the operator return value. The data type is identical to that of the operator's return value.
valargs	The value arguments of the operator invocation. The number and data types of these arguments are identical to those of the value arguments to the operator.
env	The environment handle passed to the routine

## Returns

`ODCIConst.Success` on SUCCESS, or `ODCIConst.Error` on error.

## Usage Notes

- The function should be implemented as a static method.
- `ODCIIndexStart()` is invoked to begin the evaluation of an operator on an indexed column. In particular, the following conditions hold:
  - The first argument to the operator is a column which has a domain index defined on it.
  - The indextype of the domain index (specified in `ODCIIndexInfo` parameter) supports the current operator.
  - All other arguments to the operator are value arguments (literals) which are passed in through the `<valargs>` parameters.
- The `ODCIIndexStart()` method should initialize the index scan as needed (using the operator-related information in the `pi` argument) and prepare for the subsequent invocations of `ODCIIndexFetch()`.
- The `strt` and `stop` parameters, with the `bndflg` value in `ODCIPredInfo` parameter, specify the range of values within which the operator return value should lie.

- Bounds for operator return values are specified as follows:
  - If the predicate to be evaluated is of the form `op LIKE val`, the `ODCIIndexPrefixMatch` flag is set. In this case, the start key contains the value `<val>` and the stop key value is irrelevant.
  - If the predicate to be evaluated is of the form `op = val`, the `ODCIIndexExactMatch` flag is set. In this case, the start key contains the value `<val>` and the stop key value is irrelevant.
  - If the predicate to be evaluated is of the form `op > val`, `startkey` contains the value `<val>` and stop key value is set to `NULL`. If the predicate is of the form `op >= <val>`, the flag `ODCIIndexIncludeStart` is also set.
  - If the predicate to be evaluated is of the form `op < val`, stop key contains the value `<val>` and the start key value is set to `NULL`. If the predicate is of the form `op <= val`, the flag `ODCIIndexIncludeStop` is also set.
- A context value can be returned to Oracle (through the `SELF` argument) which is then passed back to the next query-time call. The next call is to `ODCIIndexFetch()` if the evaluation continues, or to `ODCIIndexStart()` if the evaluation is restarted. The context value can be used to store the entire evaluation state or just a handle to the memory containing the state.
- Note that if the same indextype supports multiple operators with different signatures, multiple `ODCIIndexStart()` methods must be implemented, one for each distinct combination of value argument data types. For example, if an indextype supports three operators:

1. `op1(number, number)`
2. `op1(varchar2, varchar2)`
3. `op2(number, number)`

two `ODCIIndexStart` routines must be implemented:

- `ODCIIndexStart(..., NUMBER)`— handles cases (1) and (3) which has a `NUMBER` value argument
  - `ODCIIndexStart(..., VARCHAR2)`— handles case (2) which has a `VARCHAR2` value argument
- The query information in `qi` parameter can be used to optimize the domain index scan, if possible. The query information includes hints that have been specified for the query and the list of relevant ancillary operators referenced in the query block.
  - The index partition object identifier `ODCIIndexInfo.IndexPartitionIden` and the base table partition physical identifier `ODCIIndexInfo.IndexCols(1).TablePartitionIden` is passed in for local domain index. The indextype must use the new SQL syntax using the partition number and the provided `DATAOBJ_TO_MAT_PARTITION` function to query the corresponding partition of the storage system partitioned table:

```
SELECT FROM SP PARTITION(
  DATAOBJ_TO_MAT_PARTITION(
    base_table_name,
    :tab_physical_partid))
WHERE ...;
```

 **See Also:**

- [ODCIIndexFetch\(\)](#)
- [ODCIIndexStart\(\)](#)

## 20.1.12 ODCIIndexUpdate()

Invoked when a row is updated in a table that has a defined domain index on one or more of its columns.

### Syntax

```
FUNCTION ODCIIndexUpdate(
    ia ODCIIndexInfo,
    rid VARCHAR2,
    oldval icoltype,
    newval icoltype,
    env ODCIEnv)
RETURN NUMBER
```

Parameter	Description
ia	Contains information about the index and the indexed column
rid	The row identifier of the updated row
oldval	The value of the indexed column before the update. The data type is identical to that of the indexed column.
newval	The value of the indexed column after the update. The data type is identical to that of the indexed column.
env	The environment handle passed to the routine

### Returns

ODCIConst.Success ON SUCCESS, or ODCIConst.Error ON error.

### Usage Notes

- The function should be implemented as a `static` type method.
- This method should update the tables or files storing the index data for the updated row.
- In addition to a SQL `UPDATE` statement, a LOB value can be updated through a variety of `WRITE` interfaces (see *Oracle Database SecureFiles and Large Objects Developer's Guide*). If a domain index is defined on a LOB column or an object type containing a LOB attribute, the `ODCIIndexUpdate` routine is called when a LOB locator is implicitly or explicitly closed after one or more write operations.
- The index partition object identifier, `ODCIIndexInfo.IndexPartitionIden`, and the base table partition physical identifier, `ODCIIndexInfo.IndexCols(1).TablePartitionIden`, is passed in for local domain

indexes. The indextype must use the new DML syntax with the partition number, and the provided `DATAOBJ_TO_MAT_PARTITION()` function to update data in the storage system partitioned table:

```
UPDATE SP PARTITION
  (DATAOBJ_TO_MAT_PARTITION(
    base_table_name, :tab_physical_partid))
VALUES(...) SET val = :newval WHERE rowid + :rowid;
```

### 20.1.13 ODCIIndexUpdPartMetadata()

Invoked during partition maintenance operations. Patches the indextype metadata tables to correctly reflect the partition maintenance operation.

#### Syntax

```
FUNCTION ODCIIndexUpdPartMetadata(
  ia ODCIIndexInfo,
  palist ODCIPartInfoList,
  env ODCIEnv)
```

Parameter	Description
ia	The information about the domain index; does not contain partition-specific information
palist	The information about the dropped or added partitions
env	The environment handle

#### Usage Notes

- This method should be implemented as a `STATIC` type method.
- When an indextype is specified with the `SYSTEM MANAGED` approach, this method is invoked on the local domain index of this indextype during partition management operations.
- SQL DDLs are not allowed in this method.
- The indextype should update its metadata mapping specific to the partitions, if any.
- The `palist` argument contains a list of partitions that should be dropped or added. For example, if the base table operation is `ALTER TABLE SPLIT PARTITION P1 INTO P11 AND P12`, then the `palist` would have information about 3 partitions: `P1 (drop)`, `P11(add)` and `P12(add)`, along with their index partition names and index partition object identifiers.
- If the `ODCIIndexUpdPartMetadata()` call raises or returns an error, then the partition management operation on the base table is rolled back.

### 20.1.14 ODCIIndexUtilCleanup()

Cleans up temporary states created by `ODCIIndexUtilGetTableNames()`.

#### Syntax

```
FUNCTION ODCIIndexUtilCleanup (
  context PLS_INTEGER)
```

Parameter	Description
context	The number created by <code>ODCIIndexUtilGetTableNames()</code> that uniquely identifies state information for a particular index.

### Usage Notes

- The procedure should be implemented as a static type method.
- `ODCIIndexUtilCleanup()` deletes any temporary state associated with the parameter `context`.
- Exceptions raised by `ODCIIndexUtilCleanup()` are ignored by its caller.



### See Also:

- [ODCIIndexUtilGetTableNames\(\)](#)
- [ODCIIndexUtilCleanup\(\)](#)

## 20.1.15 ODCIIndexUtilGetTableNames()

Determines if the secondary tables of the domain index should be exported/imported. By default, secondary objects of the domain are not imported or exported. However, if this interface and `ODCIIndexUtilCleanup()` are present, the system invokes them.

If this interface is implemented, your application can also invoke it for transportable tablespace operations.

### Syntax

```
FUNCTION ODCIIndexUtilGetTableNames(
    ia sys.odciindexinfo,
    read_only PLS_INTEGER,
    version varchar2,
    context OUT PLS_INTEGER)
RETURN BOOLEAN
```

Parameter	Description
ia	Contains information about the index and the indexed column
read_only	Specify 1 if the encompassing transaction is read-only, meaning no writes allowed. Otherwise 0.
version	Version of export making the call.
context	A unique number that is used by <code>ODCIIndexUtilCleanup()</code> to facilitate the clean up of any state held open between <code>ODCIIndexUtilGetTableNames()</code> and <code>ODCIIndexUtilCleanup()</code>



## Returns

`TRUE` if the domain indexes' secondary tables should be exported/imported. Otherwise, the function returns `FALSE`.

## Usage Notes

- This function should be implemented as a static type method.
- This function should return `TRUE` or `FALSE` based on whether the secondary tables should be exported/imported.
- This function should return `TRUE` or `FALSE` based on whether the secondary tables should be transported. Secondary objects other than tables do not participate in transportable tablespaces. They must be recreated on the import side when the `ODCIIndexCreate()` method is invoked with the `ODCI_INDEX_TRANS_TBLSPC` bit set in the `ODCIIndexInfo.IndexInfoFlags`.

### See Also:

- [ODCIIndexUtilCleanup\(\)](#)
- [ODCIIndexCreate\(\)](#)
- [ODCIIndexUtilGetTableNames\(\)](#)

# 21

## Extensible Optimizer Interface

Consider the functions and procedures that comprise the interface to the extensible optimizer.

### 21.1 Extensible Optimizer Interface

The extensible optimizer interfaces support working with partitioned tables and domain indexes. This is accomplished in two ways:

- Additional attributes have been added to some system-defined object types that are parameters to the `ODCIStats` interface methods. For example, the `ODCIColumnInfo` type is enhanced to add information about the column's partition.
- Arguments or semantics of the arguments have changed for some `ODCIStats` methods.

Note that you must update your code for `ODCIStats2` version of the `ODCIStats` interfaces to use your statistics type with an indextype that implements the `ODCIIndex2` version of the extensible indexing interfaces.

#### 21.1.1 Using Statistics Functions in an Extensible Optimizer Interface

Consider an example of how the statistics functions might be used.

1. In the schema `HR`, we define the following operators:

```
CREATE OPERATOR Contains binding (VARCHAR2(4000), VARCHAR2(30))
RETURN NUMBER USING Contains_fn;

CREATE TYPE stat1 (
    ...,
    STATIC FUNCTION ODCIStatsSelectivity(pred ODCIPredInfo, sel OUT NUMBER,
        args ODCIArgDescList, start NUMBER, stop NUMBER, doc VARCHAR2(4000),
        key VARCHAR2(30)) return NUMBER,
    STACTIC FUNCTION ODCIStatsFunctionCost(func ODCIFuncInfo, cost OUT
        ODCICost, args ODCIArgDescList, doc VARCHAR2(4000), key VARCHAR2(30))
        return NUMBER,
    STATIC FUNCTION ODCIStatsIndexCost(ia ODCIIndexInfo, sel NUMBER,
        cost OUT ODCICost, qi ODCIQueryInfo, pred ODCIPredInfo,
        args ODCIArgDescList, start NUMBER, stop NUMBER,
        key VARCHAR2(30)) return NUMBER,
    ...
);

CREATE TABLE T (resume VARCHAR2(4000));

CREATE INDEX T_resume on T(resume) INDEXTYPE IS indtype;

ASSOCIATE STATISTICS WITH FUNCTIONS Contains_fn USING stat1;

ASSOCIATE STATISTICS WITH INDEXTYPE indtype USING stat1
WITH SYSTEM MANAGED STORAGE TABLES;
```

**2. The optimizer encounters the query**

```
SELECT * FROM T WHERE Contains(resume, 'ORACLE') = 1,
```

**3. It computes the selectivity of the predicate by invoking the user-defined selectivity function for the functional implementation of the Contains operator. In this case, the selectivity function is stat1.ODCIStatsSelectivity. It is called as follows:**

```
stat1.ODCIStatsSelectivity (
  ODCIPredInfo('HR', 'Contains_fn', NULL, 29),
  sel,
  ODCIArgDescList(
    ODCIArgDesc(ODCIConst.ArgLit,
      NULL, NULL, NULL, NULL, NULL, NULL),
    ODCIArgDesc(ODCIConst.ArgLit,
      NULL, NULL, NULL, NULL, NULL, NULL),
    ODCIArgDesc(ODCIConst.ArgCol, 'T', 'HR', '"RESUME"', NULL, NULL, NULL),
    ODCIArgDesc(ODCIConst.ArgLit,
      NULL, NULL, NULL, NULL, NULL, NULL)),
  1,
  1,
  NULL,
  'ORACLE')
```

**4. Suppose the selectivity function returns a selectivity of 3 (percent). When the domain index is being evaluated, then the optimizer calls the user-defined index cost function as follows:**

```
stat1.ODCIStatsIndexCost (  ODCIIndexInfo('HR', 'T_RESUME',
ODCIColInfoList(ODCIColInfo('HR', 'T', '"RESUME"', NULL, NULL, NULL, 0, 0, 0,
0)), NULL, 0, 0, 0, 0),      3,      cost,      NULL,      ODCIPredInfo('HR',
'Contains', NULL, 13),
ODCIArgDescList( ODCIArgDesc(ODCIConst.ArgLit,
NULL, NULL, NULL, NULL, NULL, NULL),
ODCIArgDesc(ODCIConst.ArgLit,                                NULL, NULL,
NULL, NULL, NULL, NULL),
ODCIArgDesc(ODCIConst.ArgLit,                                NULL, NULL,
NULL, NULL, NULL, NULL)),      1,      1,      'ORACLE')
```

**5. Suppose that the optimizer decides not to use the domain index because it is too expensive. Then it calls the user-defined cost function for the functional implementation of the operator as follows:**

```
stat1.ODCIStatsFunctionCost (
  ODCIFuncInfo('HR', 'Contains_fn', NULL, 1),
  cost,
  ODCIArgDescList( ODCIArgDesc(ODCIConst.ArgCol,
      'T', 'HR', '"RESUME"', NULL, NULL, NULL),
    ODCIArgDesc(ODCIConst.ArgLit,
      NULL, NULL, NULL, NULL, NULL, NULL)),
  NULL,
  'ORACLE')
```

## 21.1.2 EXPLAIN PLAN

EXPLAIN PLAN shows the user-defined CPU and I/O costs for domain indexes in the CPU\_COST and IO\_COST columns of PLAN\_TABLE. For example, suppose we have a table Emp\_tab and a user-defined operator Contains. Further, suppose that there is a domain index EmpResume\_idx on the Resume\_col column of Emp\_tab, and that the indextype of EmpResume\_idx supports the operator Contains. Then, the query

```
SELECT * FROM Emp_tab WHERE Contains(Resume_col, 'Oracle') = 1
```

might have the following plan:

OPERATION	OPTIONS	OBJECT_NAME	CPU_COST	IO_COST
SELECT STATEMENT				
TABLE ACCESS	BY ROWID	EMP_TAB		
DOMAIN INDEX		EMPRESUME_INDX	300	4

### 21.1.3 INDEX Hint

The index hint applies to domain indexes. In other words, the index hint forces the optimizer to use the hinted index for a user-defined operator, if possible.

### 21.1.4 ORDERED\_PREDICATES Hint

The hint `ORDERED_PREDICATES` forces the optimizer to preserve the order of predicate evaluation (except predicates used for index keys) as specified in the `WHERE` clause of a SQL DML statement.

## 21.2 User-Defined ODCIStats Functions

User-defined `ODCIStats` functions are used for table columns, functions, package, type, indextype or domain indexes.

**Table 21-1 Summary of User-Defined ODCIStats Functions**

Function	Description
<a href="#">ODCIGetInterfaces()</a>	Discover which version of the <code>ODCIStats</code> interface the user has implemented.
<a href="#">ODCIStatsCollect()</a>	Called by the <code>DBMS_STATS</code> package to collect user-defined statistics on a table, a partition of a table, an index, or a partition of an index.
<a href="#">ODCIStatsDelete()</a>	Deletes user-defined statistics on a table, a partition of a table, an index, or a partition of an index.
<a href="#">ODCIStatsFunctionCost()</a>	Computes the cost of a function.
<a href="#">ODCIStatsExchangePartition()</a>	Exchanges domain index statistics when an <code>ALTER TABLE EXCHANGE PARTITION ... INCLUDING INDEXES</code> command is issued.
<a href="#">ODCIStatsIndexCost()</a>	Calculates the cost of a domain index scan.
<a href="#">ODCIStatsSelectivity()</a>	Specifies the selectivity of a predicate.
<a href="#">ODCIStatsTableFunction()</a>	Provides cardinality statistics for table functions and input cursor expressions.
<a href="#">ODCIStatsUpdPartStatistics()</a>	Updates statistics during partition maintenance operations. Patches the domain index statistics.

## 21.2.1 ODCIGetInterfaces()

`ODCIGetInterfaces` is invoked by the server to discover which version of the `ODCIStats` interface the user has implemented in the methods of the user-defined statistics type.

### Syntax

```
FUNCTION ODCIGetInterfaces(
    ifclist OUT ODCIObjectList)
RETURN NUMBER;
```

Parameter	IN/OUT	Description
<code>ifclist</code>	OUT	The version of the <code>ODCIStats</code> interfaces implemented by the statistics type. This value should be <code>SYS.ODCIStats2</code> .

### Returns

`ODCIConst.Success` on success, `ODCIConst.Error` otherwise.

## 21.2.2 ODCIStatsCollect()

Called by the `DBMS_STATS` package to collect user-defined statistics.

Syntax	Description
<pre>FUNCTION ODCIStatsCollect(     col ODCIColumnInfo,     options ODCIStatsOptions,     statistics OUT RAW,     env ODCIEnv) return NUMBER;</pre>	Called by the <code>DBMS_STATS</code> package to collect user-defined statistics on a table or a partition of a table.
<pre>FUNCTION ODCIStatsCollect(     ia ODCIIndexInfo,     options ODCIStatsOptions,     statistics OUT RAW,     env ODCIEnv) return NUMBER;</pre>	Called to collect user-defined statistics on an index or a partition of an index.

Parameter	IN/OUT	Description
<code>col</code>		Column for which statistics are being collected
<code>options</code>		Options passed to <code>DBMS_STATS</code>
<code>statistics</code>		User-defined statistics collected
<code>env</code>		Contains general information about the environment in which the routine is executing

Parameter	IN/OUT	Description
ia		Domain index for which statistics are being collected

### Returns

The function returns `ODCIConst.Success`, `ODCIConst.Error`, or `ODCIConst.Warning`.

### Usage Notes

- This function should be implemented as a `STATIC` type method.
- If statistics are being collected for only one partition, the `TablePartition` field in the `ODCIColInfo` type is filled in with the name of the partition. Otherwise (if statistics must be collected for all the partitions or for the entire table), the `TablePartition` field is null.
- If the `DBMS_STATS` package methods are executed to collect user-defined statistics on a partitioned table, then  $n+1$  `ODCIStatsCollect` calls are made, where  $n$  is the number of partitions in the table. The first  $n$  calls are made with the `TablePartition` attribute in `ODCIColInfo` filled in with the partition name and the `ODCIStatsOptions.CallProperty` set to `IntermediateCall`. The last call is made with `ODCIEnv.CallPropertyflag` set to `FinalCall` to allow you to collect aggregate statistics for the entire table.
- If user-defined statistics are being collected for only one partition of the table, two `ODCIStatsCollect` calls are made. In the first, you should collect statistics for the partition. For this call, the `TablePartition` attribute of the `ODCIColInfo` structure is filled in and the `ODCIEnv.CallProperty` is set to `FirstCall`.
- In the second call you can update the aggregate statistics of the table based upon the new statistics collected for the partition. In this call, the `ODCIEnv.CallPropertyflag` is set to `FinalCall` to indicate that it is the second call. The `ODCIColInfo.TablePartition` is filled in with the partition name in both the calls.
- The `ODCIStatsCollect()` method is invoked only one time for a non-partitioned domain index, a partitioned domain index and a partition in a domain index. If the statistics are being collected only for one partition in a domain index, the `IndexPartitionNum` field in the `ODCIIndexInfo` type is filled in with the partition number. Otherwise, the `IndexPartitionNum` field is null.
- Because the statistics `OUT RAW` argument of statistics is not used in the new interface, the cartridge developer should store the user-defined statistics result in some user-defined tables.
- If a non-partitioned domain index is being `ANALYZED`, the user should collect statistics for the domain index.
- If a partitioned domain index is being `ANALYZED`,
  - `ODCIEnv.CallProperty = StatsGlobalAndPartition` means that the user should collect statistics for all partitions in the domain index and then aggregate statistics of the domain index based upon the statistics collected for all the partitions
  - `ODCIEnv.CallProperty = StatsGlobal` means that the user should aggregate domain index statistics from the statistics of all the domain index partitions.

- `ODCIEnv.CallProperty = StatsPartition` means that the user should collect statistics for all index partitions in the domain index.
- If only one partition of the domain index is being `ANALYZED`,
  - `ODCIEnv.CallProperty = StatsGlobalAndPartition` means that the user should collect statistics for the single index partition and then aggregate statistics of the domain index based upon the statistics of all the partitions.
  - `ODCIEnv.CallProperty = StatsGlobal` means that the user should aggregate domain index statistics from the statistics of all the index partitions.
  - `ODCIEnv.CallProperty = StatsPartition` means that the user should collect statistics for the single index partition.
- Note that when `ODCIEnv.CallProperty = StatsGlobalAndPartition` OR `StatsGlobal`, the user should aggregate statistics for the domain index, depending on the availability of the statistics collected for the other index partitions. If the statistics for all the index partitions are available, aggregate these statistics. If any one statistics for an index partition is absent, do nothing.
- To properly collect the statistics for a local system-managed domain index, the `IndexInfoFlags` and `IndexPartition` fields in the `ODCIIndexInfo` argument and the `CallProperty` in the `ODCIEnv` argument must be selected.
- The values in `ODCIIndexInfo.IndexPartition` can be used to determine whether statistics need to be collected for all index partitions or subpartitions. Select the following flags to determine the partition level for statistics collection.
  - If `ODCIConst.SubPartn` and `ODCIConst.CompPartn` are set, then statistics need to be collected for a single subpartition.

 **Note:**

The `ODCIConst.SubPartn` will never be set if `ODCIIndexInfo.IndexPartition` is not set.

- If `ODCIConst.CompPartn` is set, but `ODCIConst.SubPartn` is not set; then statistics need to be collected for all subpartitions of the composite partition and the composite partition itself. If `ODCIIndexInfo.IndexPartition` is not set, then statistics are collected in the same manner for all composite partitions of the index.
- If neither `ODCIConst.CompPartn` nor `ODCIConst.SubPartn` are set, then the index is not composite partitioned and statistics need to be collected for the specified partition. If `ODCIIndexInfo.IndexPartition` is not set, then statistics are collected for all partitions.

### 21.2.3 ODCIStatsDelete()

`ODCIStatsDelete` is called to delete user-defined statistics.

Syntax	Description
<pre>FUNCTION ODCIStatsDelete(   col ODCIColInfo,   statistics OUT RAW,   env ODCIEnv) return NUMBER;</pre>	Deletes user-defined statistics on a table or a partition of a table.
<pre>FUNCTION ODCIStatsDelete(   ia ODCIIndexInfo,   statistics OUT RAW,   env ODCIEnv) return NUMBER;</pre>	Deletes user-defined statistics on an index or a partition of an index.

Parameter	IN/OUT	Description
col		Column for which statistics are being deleted
statistics	OUT	Contains table-level aggregate statistics for a partitioned table or index
env		Contains general information about the environment in which the routine is executing
ia		Domain index for which statistics are deleted

### Returns

ODCIConst.Success, ODCIConst.Error, **Or** ODCIConst.Warning.

### Usage Notes

- This function should be implemented as a `STATIC` method.
- When the function is called for a non-partitioned table, the `statistics` argument in the `ODCIStatsDelete` interface is ignored.
- If the statistics are being deleted for a partitioned table, the `ODCIStatsDelete` is called  $n+1$  times. The first  $n$  calls are with the partition name filled in the `ODCIColInfo` structure and the `ODCIEnv.CallProperty` set to `IntermediateCall`. The last call is made with the `ODCIEnv.CallProperty` set to `FinalCall`.
- In the first call, delete the statistics for the specific partitions; and in the last call drop or clean up any structures created for holding statistics for the deleted table. The `ODCIColInfo.TablePartition` is set to null in the last call. In the first call, the `TablePartition` field is filled in.
- If statistics are being deleted for only one partition and the `_minimal_stats_aggregation` parameter is set to `FALSE`, two `ODCIStatsDelete` calls are made. In each call, `ODCIColInfo.TablePartition` is filled in with the partition name. On the first call, delete any user-defined statistics collected for that partition. On the second call, update the aggregate statistics for the table.
- If statistics are being deleted for one partition and `_minimal_stats_aggregation` is set to `TRUE`, `ODCIStatsDelete` is only called one to delete any user-defined statistics collected for that partition.



- The initial value of `_minimal_stats_aggregation` is `TRUE`.
- The `ODCIStatsDelete()` method is invoked only one time for non-partitioned domain index, partitioned domain index, or an index partition.
- If the statistics is being deleted for a non-partitioned domain index, the user should delete user-defined statistics for the domain index.
- If the statistics is being deleted for a partitioned domain index, the user should delete the aggregated statistics of the domain index and optionally delete user-defined statistics for all domain index partitions, depending on `Options` in `ODCIEnv.CallProperty`:
  - `ODCIEnv.CallProperty = StatsGlobalAndPartition` means that the user should delete statistics for all the domain index partitions and aggregated statistics of the domain index.
  - `ODCIEnv.CallProperty = StatsGlobal` means that the user should delete the aggregated statistics of the domain index.
  - `ODCIEnv.CallProperty = StatsPartition` is not valid option.
- If the statistics is being deleted for only one partition of the index, the user should delete user-defined statistics for the index partition.

## 21.2.4 ODCIStatsFunctionCost()

Computes the cost of a function.

### Syntax

```
FUNCTION ODCIStatsFunctionCost(
    func ODCIFuncInfo,
    cost OUT ODCICost,
    args ODCIArgDescList,
    list,
    env ODCIEnv)
return NUMBER;
```

Parameter	IN/OUT	Description
<code>func</code>		Function or type method for which the cost is being computed
<code>cost</code>	OUT	Computed cost (must be positive whole numbers)
<code>args</code>		Descriptor of actual arguments with which the function or type method was called. If the function has <i>n</i> arguments, the <code>args</code> array contains <i>n</i> elements, each describing the actual arguments of the function or type method
<code>list</code>		List of actual parameters to the function or type method; the number, position, and type of each argument must be identical in the function or type method.
<code>env</code>		Contains general information about the environment in which the routine is executing

### Returns

`ODCIConst.Success`, `ODCIConst.Error`, **Or** `ODCIConst.Warning`.

### Usage Notes

This function should be implemented as a static type method.

## 21.2.5 ODCIStatsExchangePartition()

Exchanges domain index statistics when an `ALTER TABLE EXCHANGE PARTITION ... INCLUDING INDEXES` command is issued.

### Syntax

```

FUNCTION ODCIStatsExchangePartition(
    ia ODCIIndexInfo,
    ia1 ODCIIndexInfo,
    env ODCIEnv)
return NUMBER;

```

Parameter	IN/OUT	Description
ia		Information about the index partition that must be exchanged
ia1		Information about the index of the non-partitioned table with which the partition is exchanged
env		Contains general information about the environment in which the routine is executing

### Returns

ODCIConst.Success, ODCIConst.Error, **Or** ODCIConst.Warning

### Usage Notes

- This method should be implemented as a `STATIC` type.
- This method should be capable of converting the statistics associated with a domain index partition into statistics associated with a non-partitioned domain index, and the reverse. If the statistics are missing for one of the indexes or index partitions, the user should be able to delete these statistics.

## 21.2.6 ODCIStatsIndexCost()

Calculates the cost of a domain index scan, either a scan of the entire index or a scan of one or more index partitions if a local domain index has been built.

### Syntax

```

FUNCTION ODCIStatsIndexCost(
    ia ODCIIndexInfo,
    sel NUMBER,
    cost OUT ODCICost,
    qi ODCIQueryInfo,
    pred ODCIPredInfo,
    args ODCIArgDescList,
    start operator_return_type,
    stop operator_return_type,
    list,

```

```
env ODCIEnv)
return NUMBER;
```

Parameter	IN/OUT	Description
ia		domain index for which statistics are being collected
sel		the user-computed selectivity of the predicate
cost		computed cost (must be positive whole numbers)
qi		Information about the query
pred		Information about the predicate
args		Descriptor of <i>start</i> , <i>stop</i> , and actual value arguments with which the operator was called. If the operator has <i>n</i> arguments, the <i>args</i> array contains <i>n+1</i> elements, the first element describing the start value, the second element describing the stop value, and the remaining <i>n-1</i> elements describing the actual value arguments of the operator (that is, the arguments after the first)
start		Lower bound of the operator (for example, 2 for a predicate <code>fn(...) &gt; 2</code> )
stop		Upper bound of the operator (for example, 5 for a predicate <code>fn(...) &lt; 5</code> )
list		List of actual parameters to the operator (excluding the first); the number, position, and type of each argument must be identical to the one in the operator.
env		Contains general information about the environment in which the routine is executing

## Returns

ODCIConst.Success, ODCIConst.Error, **OR** ODCIConst.Warning

## Usage Notes

- For each table in the query, the optimizer uses partition pruning to determine the range of partitions that may be accessed. These partitions are called **interesting partitions**. The set of interesting partitions for a table is also the set of interesting partitions for all domain indexes on that table. The cost of a domain index can depend on the set of interesting partitions, so the optimizer passes a list of interesting index partitions to `ODCIStatsIndexCost` in the `args` argument (the type of this argument, `ODCIArgDescList`, is a list of `ODCIArgDesc` argument descriptor types) for those arguments that are columns. For non-partitioned domain indexes or for cases where no partition pruning is possible, no partition list is passed to `ODCIStatsIndexCost`, and you should assume that the entire index is accessed.
- The domain index key can contain multiple column arguments (for example, the indexed column and column arguments from other tables appearing earlier in a join order). For each column appearing in the index key, the `args` argument contains the list of interesting partitions for the table. For example, for an index key

```
op(T1.c1, T2.c2) = 1
```

the optimizer passes a list of interesting partitions for tables T1 and T2 if they are partitioned and there is partition pruning for them.

- This function should be implemented as a static type method.
- Only a single call is made to the `ODCIStatsIndexCost()` function for queries on partitioned or non-partitioned tables. For queries on partitioned tables, additional information is passed in the `ODCIStatsIndexCost()` function. Note that some partitions in the list passed to `ODCIStatsIndexCost()` may not actually be accessed by the query. The list of interesting partitions chiefly serves to exclude partitions that are definitely not accessed.
- When the `ODCIStatsIndexCost()` function is invoked, users can fill in a string in the `IndexCostInfo` field of the cost attribute to supply any additional information that might be helpful. The string (255 characters maximum) is displayed in the `OPTIONS` column in the `EXPLAIN PLAN` output when an execution plan chooses a domain index scan.
- Users implementing this function must return 'SYS.ODCIStats2' in the `ODCIGetInterfaces()` call.

#### See Also:

- [ODCIGetInterfaces\(\)](#)
- [ODCIStatsIndexCost\(\)](#)

## 21.2.7 ODCIStatsSelectivity()

Specifies the selectivity of a predicate. The selectivity of a predicate involving columns from a single table is the fraction of rows of that table that satisfy the predicate. For predicates involving columns from multiple tables (for example, join predicates), the selectivity should be computed as a fraction of rows in the Cartesian product of those tables.

### Syntax

```
FUNCTION ODCIStatsSelectivity(
    pred ODCIPredInfo,
    sel OUT NUMBER,
    args ODCIArgDescList,
    start function_return_type,
    stop function_return_type,
    list,
    env ODCIEnv)
return NUMBER;
```

Parameter	IN/OUT	Description
pred		Predicate for which the selectivity is being computed

Parameter	IN/OUT	Description
<code>sel</code>		The computed selectivity, expressed as a number between (and including) 0 and 100, represents a percentage.  The optimizer ignores numbers less than 0 or greater than 100 as invalid values. If the computed selectivity is less than 0.5%, a value of 0 may be returned in the output parameter <code>sel</code> . A selectivity of 0 does not mean that the predicate will be removed
<code>args</code>		Descriptor of <code>start</code> , <code>stop</code> , and actual arguments with which the function, type method, or operator was called. If the function has $n$ arguments, the <code>args</code> array contains $n+2$ elements, the first element describing the start value, the second element describing the stop value, and the remaining $n$ elements describing the actual arguments of the function, method, or operator
<code>start</code>		Lower bound of the function (for example, 2 for a predicate <code>fn(... ) &gt; 2</code> )
<code>stop</code>		Upper bound of the function (for example, 5 for a predicate <code>fn(... ) &lt; 5</code> )
<code>list</code>		List of actual parameters to the function or type method; the number, position, and type of each argument must be identical to the one in the function, type method, or operator.
<code>env</code>		Contains general information about the environment in which the routine is executing

## Returns

`ODCIConst.Success`, `ODCIConst.Error`, **Or** `ODCIConst.Warning`

## Usage Notes

- As in `ODCIStatsIndexCost`, the `args` argument contains a list of *interesting* partitions for the tables whose columns are referenced in the predicate for which the selectivity has to be computed. These interesting partitions are partitions that cannot be eliminated by partition pruning as possible candidates to be accessed. The set of interesting partitions is passed to the function only if partition pruning has occurred (in other words, the interesting partitions are a strict subset of all the partitions).
- For example, when `ODCIStatsSelectivity` is called to compute the selectivity of the predicate:

```
f(T1.c1, T2.c2) > 4
```

the optimizer passes the list of interesting partitions for the table `T1` (in the argument descriptor for column `T1.c1`) if partition pruning is possible; similarly for the table `T2`.

If a predicate contains columns from several tables, this information is indicated by the flag bit `PredMultiTable`, set in the `Flags` attribute of the `pred` argument.

- This function should be implemented as a static type method.
- Users implementing this interface must return `'SYS.ODCIStats2'` in the `ODCIGetInterfaces` call.
- The selectivity of a predicate involving columns from a single table is the fraction of rows of that table that satisfy the predicate. For predicates involving columns

from multiple tables (for example, join predicates), the selectivity should be computed as a fraction of rows in the Cartesian product of those tables. For tables with partition pruning, the selectivity should be expressed relative to the cardinalities of the interesting partitions of the tables involved.

The selectivity of predicates involving columns on partitioned tables is computed relative to the rows in the interesting partitions. Thus, the selectivity of the predicate

```
g(T1.c1) < 5
```

is the percentage of rows in the set of interesting partitions (or all partitions if no partition pruning is possible) that satisfies this predicate. For predicates with columns from multiple tables, the selectivity must be relative to the number of rows in the cartesian product of the tables.

- For example, consider the predicate:

```
f(T1.c1, T2.c2) > 4
```

Suppose that the number of rows in the interesting partitions is 1000 for `T1` and 5000 for `T2`. The selectivity of this predicate must be expressed as the percentage of the 5,000,000 rows in the Cartesian product of `T1` and `T2` that satisfy the predicate.

- If a predicate contains columns from several tables, this information is indicated by the flag bit `PredMultiTable` set in the `Flags` attribute of the `pred` argument.
- A selectivity expressed relative to the base cardinalities of the tables involved may be only an approximation of the true selectivity if cardinalities (and other statistics) of the tables have been reduced based on single-table predicates or other joins earlier in the join order. However, this approximation to the true selectivity should be acceptable to most applications.
- Only one call is made to the `ODCIStatsSelectivity` function for queries on partitioned or non-partitioned tables. In the case of queries on partitioned tables, additional information is passed while calling the `ODCIStatsSelectivity` function.

## 21.2.8 ODCIStatsTableFunction()

This function provides cardinality statistics for table functions and input cursor expressions.

### Syntax

```
STATIC FUNCTION ODCIStatsTableFunction(
    func IN SYS.ODCIFuncInfo,
    outStats OUT SYS.ODCIStatFuncStats,
    argDesc IN SYS.ODCIArgDescList,
    list)
RETURN NUMBER;
```

Parameter	IN/OUT	Description
<code>func</code>		Table function name
<code>outStats</code>		Number of rows expected to be returned

Parameter	IN/OUT	Description
argDesc		Description of the arguments to the table function
<i>list</i>		The arguments' compile-time values. Expressions that only have values at run time are represented by nulls.

### Returns

ODCIConst.Success, ODCIConst.Error, **OR** ODCIConst.Warning.

## 21.2.9 ODCIStatsUpdPartStatistics()

Updates statistics during partition maintenance operations. This lets the statistics type patch up the domain index statistics to correctly reflect the partition maintenance operation.

### Syntax

```

STATIC FUNCTION ODCIStatsCollect(
    ia ODCIIndexInfo,
    palist ODCIPartInfoList,
    env ODCIEnv)
RETURN NUMBER

```

Parameter	IN/OUT	Description
ia		Contains information about the domain index. It does not contain any partition specific information
palist		Contains information about the partitions that are to be dropped or added
env		Environment handle passed to the routine

### Returns

ODCIConst.Success, ODCIConst.Error, **OR** ODCIConst.Warning.

- When the statistics type is specified by the `SYSTEM MANAGED` approach, then the [ODCIStatsUpdPartStatistics\(\)](#) method is invoked only one time during PMO. Only DML and query are allowed in the method implementation.
- If the user maintains the domain index statistics in a global non-partitioned table, then the user should delete the entry for the user-defined statistics for the dropped partition (and optionally add a `NULL` entry for added partition). They can then check if `ODCIEnv.CallProperty` is `StatsGlobalAndPartition` **OR** `StatsPartition`. If `ODCIEnv.CallProperty` is `StatsGlobalAndPartition` then they should aggregate all the available index partition statistics. If `ODCIEnv.CallProperty` is `StatsPartition` they can simply delete the aggregate statistics, or leave the aggregate statistics as they are. `ODCIEnv.CallProperty` cannot be `StatsGlobal` for this call.
- The user should use the information passed in by the `ODCIEnv.CallProperty` to determine the type of statistics to delete and adjust.

- If the method returns `ODCIConst.Error`, the error is ignored and the partition management operation continues.



# 22

## User-Defined Aggregate Functions Interface

These routines must be implemented to define a user-defined aggregate function. The routines are implemented as methods in an object type. Then the `CREATE FUNCTION` statement is used to actually create the aggregate function.



**See Also:**

[Using User-Defined Aggregate Functions](#)

### 22.1 User-Defined Aggregate Functions

The methods described here are implemented as methods in an object type. The `CREATE FUNCTION` statement is used to actually create the aggregate function. [Table 22-1](#) summarizes these functions.

**Table 22-1 Summary of User-Defined Aggregate Functions**

Function	Description
<a href="#">ODCIAggregateDelete()</a>	Removes an input value from the current group.
<a href="#">ODCIAggregateInitialize()</a>	Initializes the aggregation context and instance of the implementation object type, and returns it as an <code>OUT</code> parameter.
<a href="#">ODCIAggregateIterate()</a>	Iterates through input rows by processing the input values, updating and then returning the aggregation context. <b>Note</b> : <code>ODCIAggregateIterate</code> is not invoked for null values.
<a href="#">ODCIAggregateMerge()</a>	Merges two aggregation contexts into a single object instance during either serial or parallel evaluation of the user-defined aggregate.
<a href="#">ODCIAggregateTerminate()</a>	Calculates the result of the aggregate computation and performs all necessary cleanup, such as freeing memory.
<a href="#">ODCIAggregateWrapContext()</a>	Integrates all external pieces of the current aggregation context to make the context self-contained.

#### 22.1.1 `ODCIAggregateDelete()`

Removes an input value from the current group. The routine is invoked by Oracle by passing in the aggregation context and the value of the input to be removed during It

processes the input value, updates the aggregation context, and returns the context. This is an optional routine and is implemented as a member method.

### Syntax

```
MEMBER FUNCTION ODCIAggregateDelete(
    self IN OUT <impltype>,
    val <inputdatatype>)
RETURN NUMBER
```

Parameter	IN/OUT	Description
self	IN OUT	As input, the value of the current aggregation context; as output, the updated value.
val	IN	The input value that is being removed from the current group.

### Returns

`ODCIConst.Success` on success, or `ODCIConst.Error` on error.

## 22.1.2 ODCIAggregateInitialize()

Initializes the aggregation context and instance of the implementation object type, and returns it as an `OUT` parameter. Implement this routine as a static method.

### Syntax

```
STATIC FUNCTION ODCIAggregateInitialize(
    actx IN OUT <impltype>)
RETURN NUMBER
```

Parameter	In/Out	Description
actx	IN OUT	The aggregation context that is initialized by the routine. This value is <code>NULL</code> for regular aggregation cases. In aggregation over windows, <code>actx</code> is the context of the previous window. This object instance is passed in as a parameter to the next aggregation routine.

### Returns

`ODCIConst.Success` on success, or `ODCIConst.Error` on error.

## 22.1.3 ODCIAggregateIterate()

Iterates through input rows by processing the input values, updating and then returning the aggregation context. This is a mandatory routine and is implemented as a member method.

### Syntax

```
MEMBER FUNCTION ODCIAggregateIterate(
    self IN OUT <impltype>,
    val <inputdatatype>)
RETURN NUMBER
```

Parameter	IN/OUT	Description
self	IN OUT	As input, the value of the current aggregation context; as output, the updated value.
val	IN	The input value that is being aggregated.

### Returns

ODCIConst.Success **ON SUCCESS**, or ODCIConst.Error **ON ERROR**.

## 22.1.4 ODCIAggregateMerge()

Merges two aggregation contexts into a single object instance during either serial or parallel evaluation of the user-defined aggregate. This is a mandatory routine and is implemented as a member method.

### Syntax

```
MEMBER FUNCTION ODCIAggregateMerge(
    self IN OUT <impltype>,
    ctx2 IN <impltype>)
RETURN NUMBER
```

Parameter	IN/OUT	Description
self	IN OUT	On input, the value of the first aggregation context; on output, the resulting value of the two merged aggregation contexts.
ctx2	IN	The value of the second aggregation context.

### Returns

ODCIConst.Success **ON SUCCESS**, or ODCIConst.Error **ON ERROR**.

If the user-defined aggregate is a window function, and it is not possible to make an implementation of ODCIAggregateMerge(), ODCIConst.Error should be returned. This error is translated as an Oracle user error.

## 22.1.5 ODCIAggregateTerminate()

Calculates the result of the aggregate computation and performs all necessary cleanup, such as freeing memory. Invoked by Oracle as the last step of aggregate computation. This is a mandatory routine and is implemented as a member method.

### Syntax

```
MEMBER FUNCTION ODCIAggregateTerminate(
    self IN <impltype>,
    ReturnValue OUT <return_type>,
    flags IN number)
RETURN NUMBER
```

Parameter	IN/OUT	Description
self	IN	The value of the aggregation context.
ctx2	OUT	The resultant aggregation value.
flags	IN	A bit vector that indicates various options. A set bit of <code>ODCI_AGGREGATE_REUSE_CTX</code> indicates that the context is reused and any external context should not be freed.

### Returns

`ODCIConst.Success` on SUCCESS, or `ODCIConst.Error` on error.



#### See Also:

"[Reuse of Aggregation Context for Analytic Functions](#)" for details on setting the `ODCI_AGGREGATE_REUSE_CTX` flag bit.

## 22.1.6 ODCIAggregateWrapContext()

Integrates all external pieces of the current aggregation context to make the context self-contained. Invoked by Oracle if the user-defined aggregate has been declared to have external context and is transmitting partial aggregates from slave processes. This is an optional routine and is implemented as a member method.

### Syntax

```
MEMBER FUNCTION ODCIAggregateWrapContext(
    self IN OUT <impltype>)
RETURN NUMBER
```

Parameter	IN/OUT	Description
self	IN	On input, the value of the current aggregation context; on output, the self-contained combined aggregation context.

### Returns

`ODCIConst.Success` on SUCCESS, or `ODCIConst.Error` on error.



#### See Also:

"[Handling Large Aggregation Contexts](#)" for more information on using this function

# 23

## Pipelined and Parallel Table Functions

These routines must be implemented to define pipelined and parallel table functions in C.



### See Also:

[Using Pipelined and Parallel Table Functions](#) for an overall explanation of pipelined and parallel table functions

### 23.1 Routines for Pipelined and Parallel Table Functions in C

The following C methods, summarized in support parallel and pipelined table functions.

**Table 23-1 Summary of Pipelined and Parallel Table Functions for C**

Function	Description
<a href="#">ODCITableClose()</a>	Performs cleanup operations after scanning a table function.
<a href="#">ODCITableDescribe()</a>	Returns describe information for a table function whose return type is ANYDATASET.
<a href="#">ODCITableFetch()</a>	returns the next batch of rows from a table function.
<a href="#">ODCITablePrepare()</a>	Prepares the scan context and other query information at compile time.
<a href="#">ODCITableStart()</a>	initializes the scan of a table function.

#### 23.1.1 ODCITableClose()

`ODCITableClose` performs cleanup operations after scanning a table function.

#### Syntax

```
MEMBER FUNCTION ODCITableClose(  
    self IN <imptype>)  
RETURN NUMBER;
```

Parameter	In/Out	Description
self	IN	The scan context set up by previous scan routine invocation

## Returns

`ODCIConst.Success` on **SUCCESS**, `ODCIConst.Error` otherwise.

## Usage Notes

- Oracle invokes `ODCItableClose` after the last fetch call. The scan context is passed in as a parameter. `ODCItableClose` then performs any necessary cleanup operations, such as freeing memory.
- If `ODCItablePrepare` is implemented, this routine is only called one time, at the end of query execution, rather than each time the table function exits.

## 23.1.2 ODCItableDescribe()

`ODCItableDescribe` returns describe information for a table function whose return type is `ANYDATASET`.

## Syntax

```
STATIC FUNCTION ODCItableDescribe(
    rtype OUT ANYTYPE,
    <args>)
RETURN NUMBER;
```

Parameter	In/Out	Description
<code>rtype</code>	OUT	The <code>AnyType</code> value that describes the returned rows from the table function
<code>args</code>	IN	The set of zero or more user specified arguments for the table function.

## Returns

`ODCIConst.Success` on **SUCCESS**, `ODCIConst.Error` otherwise.

## Usage Notes

- If the optional routine `ODCItableDescribe` is implemented, Oracle invokes it at query compilation time to retrieve the specific type information.
- This interface is applicable only for table functions whose return type is `ANYDATASET`. The format of elements within the returned collection is conveyed to Oracle by returning an instance of `ANYTYPE`. The `ANYTYPE` instance specifies the actual structure of the returned rows of the specific query.
- `ANYTYPE` provides a data type to model the metadata of a row: the names and data types of all the columns (fields) comprising the row. It also provides a set of PL/SQL and C interfaces for users to construct and access the metadata information. `ANYDATASET`, like `ANYTYPE`, contains a description of a given type, but `ANYDATASET` also contains a set of data instances of that type
- The following example shows a query on a table function that uses the `ANYDATASET` type:

```
SELECT * FROM
TABLE(CAST(AnyBooks('http://.../books.xml') AS ANYDATASET));
```

At query compilation time, Oracle invokes the `ODCITableDescribe` routine. The routine typically uses the user arguments to figure out the nature of the return rows. In this example, `ODCITableDescribe` consults the DTD of the XML documents at the specified location to determine the appropriate `ANYTYPE` value to return. Each `ANYTYPE` instance is constructed by invoking the constructor APIs with this field name and data type information.

- Any arguments of the table function that are not constants are passed to `ODCITableDescribe` as `NULLS` because their values are not known at compile time.



#### See Also:

[Transient and Generic Types](#) for a discussion of `ANYTYPE`, `ANYDATA`, and `ANYDATASET`

## 23.1.3 ODCITableFetch()

`ODCITableFetch` returns the next batch of rows from a table function.

### Syntax

```
MEMBER FUNCTION ODCITableFetch(
    self IN OUT <imptype>,
    nrows IN NUMBER,
    rws OUT <coll-type>)
RETURN NUMBER;
```

Parameter	In/Out	Description
<code>self</code>	IN OUT	The in-bound is the scan context set up by previous scan routine invocation; the outbound is the scan context to be passed to later scan routine invocations.
<code>nrows</code>	IN	The number of rows the system expects in the current fetch cycle. The method can ignore this value and return a different number of rows. If fewer rows are returned, the method is called again; if more rows are returned, they are processed in the next cycle.
<code>rws</code>	OUT	The next batch of rows from the table function. This is returned as an instance of the same collection type as the return type of the table function.

### Returns

`ODCIConst.Success` on success, `ODCIConst.Error` otherwise.

### Usage Notes

- `ODCITableFetch` is invoked one or more times by Oracle to retrieve all the rows in the collection returned by the table function. The scan context is passed in as a parameter. Typically `ODCITableFetch` uses the input scan context and computes the next set of rows to be returned to Oracle. In addition, it may update the scan context accordingly.
- Returning more rows in each invocation of `fetch()` reduces the number of fetch calls that must be made and thus improves performance.

- Oracle calls `ODCITableFetch` repeatedly until all rows in the table function's collection have been returned. When all rows have been returned, `ODCITableFetch` should return a null collection.

## 23.1.4 ODCITablePrepare()

Prepares the scan context and other query information at compile time.

### Syntax

```
STATIC FUNCTION ODCITablePrepare(
    sctx OUT <imptype>,
    tf_info SYS.ODCITabFuncInfo,
    args);
```

Parameter	In/Out	Description
<code>sctx</code>	OUT	The scan context returned by this routine. This value is passed in as a parameter to the later scan routines. The scan context is an instance of the object type containing the implementation of the <code>ODCITable</code> routines.
<code>tf_info</code>		Contains the projection information and the return type's table descriptor object (TDO): <ul style="list-style-type: none"> <li>• <code>Attrs</code> (<code>SYS.ODCINumberList</code>): lists the positions of the referenced attributes of the table function's output collection type</li> <li>• <code>RefType</code> (<code>SYS.AnyType</code>): for <code>AnyDataSet</code> table functions, this is the actual return type expected to be returned in the <code>AnyDataSet</code> collection.</li> </ul>
<code>args</code>	IN	The arguments that are passed to the table function. This method is invoked at compile time; thus, only literal arguments have values. Column and expression arguments are passed as null values.

### Usage Notes

- This method prepares the scan context based on the information known at compile time. This scan context is passed to `ODCITableStart` when it is called at the beginning of query execution.
- If this optional method is implemented, `ODCITableClose` is only called one time, at the end of query execution. Each time the table function is restarted, `ODCITableStart` is called and passed the scan context. This allows the table function to maintain context between restarts, and to perform cleanup operations only one time at the end of query execution.

## 23.1.5 ODCITableStart()

`ODCITableStart` initializes the scan of a table function.

### Syntax

```
STATIC FUNCTION ODCITableStart(
    sctx IN OUT <imptype>,
    <args>)
RETURN NUMBER;
```



---

Parameter	In/Out	Description
self	IN OUT	The scan context returned by this routine. This value is passed in as a parameter to the later scan routines. The scan context is an instance of the object type containing the implementation of the <code>ODCItable</code> routines. If <code>ODCItablePrepare</code> is implemented, the scan context it creates is passed in to <code>ODCItableStart</code> .
args	IN	Set of zero or more arguments specified by the user for the table function
rows	OUT	The next batch of rows from the table function. This is returned as an instance of the same collection type as the return type of the table function.

---

### Returns

`ODCIConst.Success` on success, `ODCIConst.Error` otherwise.

### Usage Notes

- If `ODCItablePrepare` is not implemented, this is the first routine that is invoked to begin retrieving rows from a table function. This routine typically performs the setup needed for the scan. The scan context is created (as an object instance `sctx`) and returned to Oracle. The arguments to the table function, specified by the user in the `SELECT` statement, are passed in as parameters to this routine. If `ODCItablePrepare` is implemented, it creates the scan context at compile time, and that scan context is passed in to this routine.
- Any `REF CURSOR` arguments of the table function must be declared as `SYS_REFCURSOR` type in the declaration of the `ODCItableStart` method.

# A

## User-Managed Local Domain Indexes

The user-managed approach for partitioning domain indexes has been the only method available until Oracle Database 11g Release 1, when system-managed partitioning was introduced. The user-managed approach has three significant limitations:

- Because the extensible indexing framework does not store information about the domain index related objects in the kernel, you must maintain tables and partitions by invoking user-supplied routines.
- Because the kernel does not support equipartitioned tables, each partition has to have a set of tables and dependent schema objects, which must be managed programmatically in the user-managed indexing code.

As the number of partitions increases, the proliferation of domain index storage objects can become an obstacle to efficient operation. To use a table that contains images and has 1,000 partitions, an indexing schema that creates 64 bitmap indexes on its storage table (after it is extended to support local domain indexes) would need create and manage 1,000 domain index storage tables and 64,000 bitmap indexes.

- During DML and query processing with local domain indexes, you would need a separate set of cursors for each partition; this is required because each partition has its own set of tables. As a consequence, applications that use a large number of partitions and require access to several partitions simultaneously must compile new SQL cursors at run-time, which impacts performance.

Oracle recommends that you use the system-managed approach, as described in [Building Domain Indexes](#).

Oracle plans to deprecate the user-managed approach in a future release. Information provided in this appendix documents the specific differences between the user-managed and system managed processes and APIs.

### A.1 Comparing User-Managed and System-Managed Domain Indexes

An alternative approach would be to use system-managed domain indexes. It addresses these limitations and has the following benefits:

- Because the kernel performs many more maintenance tasks on behalf of the user, there is no need for programmatic support for table and partition maintenance operations. These operations can be implemented by taking actions in the server and by using a very minimal set of interface routines. The cartridge code can then be relatively unaware of partition issues.
- The number of objects that must be managed to support local partitioned domain indexes is identical to the number for non-partitioned domain indexes. For local partitioned indexes, the domain index storage tables are equipartitioned with

respect to the base tables; therefore, the number of domain index storage tables does not increase with an increase in the number of partitions.

- A single set of query and DML statements can now access and manipulate the system-partitioned storage tables, facilitating cursor sharing and enhancing performance.

## A.2 Truncating Domain Indexes

There is no explicit statement for truncating a domain index. However, when the corresponding table is truncated, your indextype's truncate method is invoked. For example:

```
TRUNCATE TABLE MyEmployees;
```

truncates `ResumeTextIndex` by calling your `ODCIIndexTruncate()` method.

## A.3 Creating Indextypes

Use the following syntax to create indextypes for the user-managed domain indexes.

```
CREATE INDEXTYPE TextIndexType  
FOR Contains (VARCHAR2, VARCHAR2)  
USING TextIndexMethods;
```

## A.4 Using Domain Indexes for the Indextype

In order for the indextype to be able to use local domain indexes, the methods have to be declared when the indextype is created:

```
CREATE INDEXTYPE TextIndexType  
FOR Contains (VARCHAR2, VARCHAR2)  
USING TextIndexMethods  
WITH LOCAL RANGE PARTITION;
```

## A.5 Partitioning Domain Indexes

The user-managed approach uses the methods `ODCIIndexMergePartition()` and `ODCIIndexSplitPartition()` to support local domain indexes.

## A.6 APIs for User-Managed Domain Indexes

The following methods are used only in the user-managed implementation of domain indexes.

### A.6.1 `ODCIIndexTruncate()`

This is an index definition method. When a user issues a `TRUNCATE` statement against a table that contains a column or object type attribute indexed by your indextype, Oracle calls your `ODCIIndexTruncate()` method. This method should leave the domain index empty.

## Syntax

```
FUNCTION ODCIIndexTruncate(
    ia ODCIIndexInfo,
    env ODCIEnv)
RETURN NUMBER
```

Parameter	Description
ia	Contains information about the indexed column
env	The environment handle passed to the routine

## Returns

ODCIConst.Success on success, or ODCIConst.Error on error, or ODCIConst.Warning.

While truncating a local domain index, the first  $N+1$  calls can return ODCIConst.ErrContinue 100.

## Usage Notes

- This function should be implemented as a static type method.
- After this function executes, the domain index should be empty (corresponding to the empty base table).
- While the ODCIIndexTruncate() routine is being executed, the domain index is marked LOADING. If the ODCIIndexTruncate() routine returns with an ODCIConst.Error (or exception), the domain index is marked FAILED. The only operation permitted on FAILED domain indexes is DROP INDEX, TRUNCATE TABLE or ALTER INDEX REBUILD. If ODCIIndexTruncate() returns with ODCIConst.Warning, the operation succeeds but a warning message is returned to the user.
- Every SQL statement executed by ODCIIndexTruncate() is treated as an independent operation. The changes made by ODCIIndexTruncate() are not guaranteed to be atomic.
- This method is invoked for truncating a non-partitioned index, truncating a local domain index, and also for truncating a single index partition during ALTER TABLE TRUNCATE PARTITION.

For truncating a non-partitioned index, the ODCIIndexTruncate() is invoked with the IndexPartition, TablePartition and callProperty set to NULL.

For truncating a local domain index, the routine is invoked  $N+2$  times, where  $N$  is the number of partitions.

For truncating a single index partition during ALTER TABLE TRUNCATE PARTITION, this routine is invoked with the IndexPartition and the TablePartition filled in and the callProperty set to NULL.



### See Also:

[ODCIIndexTruncate\(\)](#)

## A.6.2 ODCIIndexMergePartition()

Invoked when a `ALTER TABLE MERGE PARTITION` is issued on range partitioned table on which a domain index is defined.

### Syntax

```
FUNCTION ODCIIndexMergePartition(
    ia ODCIIndexInfo,
    part_name1 ODCIPartInfo,
    part_name2 ODCIPartInfo,
    parms VARCHAR2,
    env ODCIEnv)
RETURN NUMBER
```

Parameter	Description
ia	Contains index and table partition name for one of the partitions to be merged
part_name1	Contains index and table partition name for the second partition to be merged
part_name2	Holds index and table partition name for the new merged partition
parms	Contains the parameter string for the resultant merged partition, essentially the default parameter string associated with the index.
env	The environment handle passed to the routine

### Returns

`ODCIConst.Success` ON SUCCESS, OR `ODCIConst.Error` ON error, OR `ODCIConst.Warning`.

### Usage Notes

- The function should be implemented as a static type method.
- You should create a new table representing the resultant merged partition and populate it with data from the merged partitions. Then drop the tables corresponding to the merged index partitions.
- The newly created partition should pick the default parameter string associated with the index level. Resulting local index partitions are marked `UNUSABLE`; you should not attempt to populate the data in the new partition until after an `ALTER INDEX REBUILD PARTITION` call.
- The old table and the dictionary entries for the old index partitions are deleted before the call to [ODCIIndexMergePartition\(\)](#), so the cartridge code for this routine should not rely on the existence of this data in the views.

## A.6.3 ODCIIndexSplitPartition()

Invoked when an `ALTER TABLE SPLIT PARTITION` is invoked on a partitioned table where a domain index is defined.

## Syntax

```
FUNCTION ODCIIndexSplitPartition(
    ia ODCIIndexInfo,
    part_name1 ODCIPartInfo,
    part_name2 ODCIPartInfo,
    parms VARCHAR2,
    env ODCIEnv)
RETURN NUMBER
```

Parameter	Description
ia	Contains the information about the partition to be split
part_name1	Holds the index and table partition names for one of the new partitions
part_name2	Holds the index and table partition names for the other new partition
parms	Contains the parameter string for the new partitions, the string associated with the index partition that is being split.
env	The environment handle passed to the routine

## Returns

ODCIConst.Success **on success**, or ODCIConst.Error **on error**, or ODCIConst.Warning.

## Usage Notes

- The function should be implemented as a static type method.
- You must to drop the metadata corresponding to the partition that is split, and create metadata for the two newly created partitions.
- The new tables should pick up the default parameter string associated with the split partition.
- The index data corresponding to these partitions need not be computed since the indexes are marked `UNUSABLE`. The indexes can be built after an `ALTER INDEX REBUILD PARTITION` call makes the indexes usable again.
- The old table and the old index partition's dictionary entries are deleted before the call to `ODCIIndexSplitPartition()`, so the cartridge code for this routine should not rely on the existence of this data in the views.

# Index

## Symbols

---

.so files  
naming conventions, [2-5](#)

## A

---

aggregate function, user-defined, [12-1](#)  
analytic functions, [12-7](#), [12-8](#)  
analytic functions and external context, [12-8](#)  
creating, [12-2](#)  
defining, [12-1](#), [12-2](#)  
example, [12-9](#)  
external context, [12-8](#)  
external context and parallel aggregation,  
[12-6](#)  
implementing, [12-2](#)  
large aggregation contexts, [12-5](#)  
ODCIAggregate interface, [12-1](#), [22-1](#)  
ODCIAggregateDelete, [12-7](#), [22-1](#)  
ODCIAggregateInitialize, [12-1](#), [22-2](#)  
ODCIAggregateIterate, [12-1](#), [22-2](#)  
ODCIAggregateMerge, [12-2](#), [22-3](#)  
ODCIAggregateTerminate, [12-2](#), [22-3](#)  
ODCIAggregateWrapContext, [12-6](#), [22-4](#)  
parallel evaluation, [12-4](#)  
reuse for analytic functions, [12-7](#)  
using, [12-3](#)  
using materialized views, [12-8](#)  
aggregate interface, [22-1](#)  
Alias library, [5-1](#)  
ALL\_INDEXTYPE\_COMMENTS view, [8-8](#)  
analytic functions, [12-7](#), [12-8](#)  
ancillary binding, [9-10](#)  
ANYTYPE type, [13-23](#)  
Associating the Extensible Optimizer Methods  
with Database Objects, [15-48](#)  
attributes of object type, [15-1](#)  
referencing in method, [4-4](#)  
autonomous transaction restriction, [13-7](#)

## B

---

B-tree indexing algorithm, [7-2](#)  
B+trees, [1-7](#)

binary large object, see BLOB, [6-1](#)  
binding, [8-2](#), [9-1](#)  
BLOB, [6-1](#)  
EMPTY\_BLOB function, [6-3](#)

## C

---

C and C++  
debugging DLLs, [5-11](#)  
differences from PL/SQL, [4-5](#)  
callback  
restrictions, [5-10](#)  
Callback Restrictions, [5-10](#)  
character large object, see CLOB, [6-1](#)  
character sets  
support for, [2-9](#)  
CLOB, [6-1](#)  
EMPTY\_CLOB function, [6-3](#)  
collection types, [1-5](#)  
complex data objects, [1-2](#)  
configuration files  
naming conventions, [2-5](#)  
configuration files for external procedures, [5-5](#)  
constructor method, [3-3](#)  
content, [1-2](#)  
content of data cartridge, [1-2](#)  
context  
inline, [12-6](#)  
WITH CONTEXT clause, [5-9](#)  
conventions  
naming, [2-6](#)  
corruption of package, [4-6](#)  
cost model, [1-8](#)  
CREATE FUNCTION statement, [22-1](#)  
CREATE LIBRARY  
CREDENTIAL option, [5-1](#)  
DIRECTORY object option, [5-1](#)  
CREATE TYPE  
syntax, [1-9](#)  
CREATE TYPE BODY statement, [4-1](#)  
CREATE TYPE with OID statement, [3-2](#)  
Creating Statistics Table (PowerCartUserStats),  
[15-32](#)

## D

data cartridge

- complex data objects, [1-2](#)
- content, [1-2](#)
- definition, [1-1](#)
- development process, [2-1](#)
- domains, [1-2](#)
- external procedures (guidelines), [5-12](#)
- installation, [2-3](#)
- interfaces, [1-9](#)
- key characteristics, [1-1](#)
- method, [1-5](#)
- naming conventions, [2-6](#)
- Oracle Multimedia, [1-3](#)
- Oracle Spatial, [1-3](#)
- Oracle Text, [1-3](#)
- scope, [1-2](#)
- suggested development approach, [2-10](#)

data objects, [1-2](#)

data types

- collection, [1-5](#)
- extensibility, [1-4](#)
- REF (relationship), [1-5](#)
- reference, [1-5](#)
- specifying, [5-6](#)
- user-defined type, [1-4](#)

DBA\_INDEXTYPE\_COMMENTS view, [8-8](#)

DBA\_SECONDARY\_OBJECTS view, [8-13](#)

DBMS interfaces, [1-9](#)

DBMS\_LOB package, [6-9](#)

- compared with OCI, [6-4](#)

DBMS\_STATS package

- used in optimizer, [1-8](#)

DDL

- for LOBs, [6-1](#)

DEBUG\_EXTPROC, Using, [5-11](#)

debugging

- C code in DLLs, [5-11](#)
- common errors, [4-5](#)
- PL/SQL, [4-4](#)

Debugging External Procedures, [5-11](#)

demo directory (PL/SQL), [18-2](#)

demo file (extdemo1.sql)

- extensible indexing in power demand example, [15-12](#)

directories

- installation, [2-5](#)

DIRECTORY Object Option, [5-2](#)

DLL

- debugging, [5-11](#)
- naming conventions, [2-5](#)

domain index, [7-5](#), [8-1](#)

domain indexes, [7-6](#), [8-8](#)

- creating, [15-12](#)

domain indexes (*continued*)

- creating (*continued*)
- parallelizing, with table functions, [13-22](#)
- definition, [1-7](#)
- exporting and importing, [8-12](#)
- loading, [8-19](#)
- moving, [8-12](#)

domain of data cartridge, [1-2](#)

## E

electric utility example, [15-1](#)

EMPTY\_BLOB function, [6-3](#)

EMPTY\_CLOB function, [6-3](#)

error messages

- naming conventions, [2-4](#)

exception

- raising (OCIExtProcRaiseExcp), [18-1](#)
- raising (OCIExtProcRaiseExcpWithMsg), [18-2](#)

execution plan

- definition, [1-8](#)

extdemo1.sql demo file (extensible indexing in power demand example), [15-12](#)

extensibility

- data types, [1-4](#)
- indexing, [1-7](#)
- interfaces, [1-9](#)
- optimizer, [1-8](#)
- server execution environment, [1-6](#), [2-4](#)
- services, [1-4](#)
- collections, [1-5](#)
- data types, [1-4](#)
- method, [1-5](#)
- reference type, [1-5](#)

extensibility interfaces, [1-1](#)

extensibility services, [1-4](#)

extensible database, [1-1](#)

extensible indexing, [1-7](#)

- necessary application processes, [1-7](#)
- necessary database processes, [1-8](#)
- queries benefitting, [15-10](#), [15-11](#)

extensible indexing framework, [7-5](#)

extensible optimizer, [1-8](#)

external context, [12-8](#)

external context and parallel aggregation, [12-6](#)

external LOB, [6-1](#)

external procedure

- configuration files for, [5-5](#)
- guidelines, [5-12](#)
- guidelines for using with data cartridge, [5-12](#)
- how PL/SQL calls, [5-4](#)
- LOBs in, [6-10](#)
- OCI access functions, [18-1](#)
- overview, [5-2](#)



external procedure (*continued*)  
 PARAMETERS clause, [5-8](#)  
 passing parameters to, [5-6](#)  
 registering, [5-3](#)  
 specifying data types, [5-6](#)  
 WITH CONTEXT clause, [5-9](#)  
 External Procedures, Debugging, [5-11](#)  
 extproc process, [5-12](#)

## F

---

foundational data cartridges  
 Oracle Multimedia, [1-3](#)  
 Oracle Spatial, [1-3](#)  
 Oracle Text, [1-3](#)

## G

---

generic types  
 See ANYTYPE type  
 Globalization Support, [2-9](#)  
 globals  
 naming conventions, [2-4](#)

## H

---

hash index, [1-7](#)

## I

---

implementation type, [8-2](#)  
 index  
 domain  
 creating, [15-12](#)  
 metadata for, [15-30](#)  
 index scan, [9-6](#)  
 index-organized table, [7-5](#)  
 indexing  
 extensible  
 queries benefitting, [15-11](#)  
 queries not benefitting, [15-10](#)  
 indextype, [8-1](#)  
 definition, [1-1](#), [1-7](#)  
 indextype implementation methods, [15-17](#)  
 indextypes, [7-5](#), [16-1](#)  
 operators and, [9-4](#)  
 initialization, ODCIAggregate, [12-1](#)  
 inline, context, [12-6](#)  
 installation directory  
 naming conventions, [2-5](#)  
 installation of data cartridge, [2-3](#)  
 interfaces  
 data cartridge, [1-9](#)  
 DBMS, [1-9](#)

interfaces (*continued*)  
 extensibility, [1-9](#)  
 service, [1-9](#)  
 internal LOB, [6-1](#)  
 iteration, ODCIAggregate, [12-1](#)

## J

---

join order, [1-8](#)

## K

---

Knuth, [7-2](#)

## L

---

large aggregation contexts, [12-5](#)  
 large object, see LOB, [6-1](#)  
 library  
 alias, [5-1](#)  
 shared, [2-5](#), [5-1](#)  
 LOB  
 DDL for, [6-1](#)  
 external, [6-1](#)  
 external procedure use, [6-10](#)  
 internal, [6-1](#)  
 OCI use with, [6-4](#)  
 triggers and, [6-11](#)  
 value, [6-1](#)  
 LOBs  
 overview, [1-5](#)  
 local domain indexes, [8-15](#), [16-1](#)

## M

---

Maintaining Context - Java, [18-3](#)  
 map methods, [3-4](#)  
 materialized views  
 user-defined aggregate function, [12-8](#)  
 member method, [3-1](#), [4-1](#)  
 merge, ODCIAggregate, [12-2](#)  
 message files  
 naming conventions, [2-5](#)  
 metadata  
 index, [15-30](#)  
 method, [1-5](#), [15-1](#)  
 constructor, [3-3](#)  
 implementing, [4-1](#)  
 invoking, [4-3](#)  
 map, [3-4](#)  
 member, [3-1](#), [4-1](#)  
 order, [3-4](#)  
 referencing attributes, [4-4](#)

## N

---

- naming conventions, [2-6](#)
  - configuration files, [2-5](#)
  - error messages, [2-4](#)
  - globals, [2-4](#)
  - installation directory, [2-5](#)
  - message files, [2-5](#)
  - name format, [2-6](#)
  - need for, [2-6](#)
  - schema, [2-4](#)
  - shared libraries, [2-5](#)
- national language support (NLS). See [Globalization Support, 2-9](#)
- NCLOB, [6-1](#)
- NLS (national language support). See [Globalization Support, 2-9](#)

## O

---

- object identifier (OID)
  - with CREATE TYPE, [3-2](#)
- object type
  - attributes, [15-1](#)
  - comparisons, [3-4](#)
  - methods, [15-1](#)
- OCI
  - LOB manipulation functions, [6-4](#)
- OCIExtProcAllocMemory routine, [18-1](#)
- OCIExtProcRaiseExcp routine, [18-1](#)
- OCIExtProcRaiseExcpWithMsg routine, [18-2](#)
- OCILob...() functions, [6-4](#)
- ODCIAggregate interface, [12-1, 22-1](#)
  - ODCIAggregateDelete, [22-1](#)
  - ODCIAggregateInitialize, [22-2](#)
  - ODCIAggregateIterate, [22-2](#)
  - ODCIAggregateMerge, [22-3](#)
  - ODCIAggregateTerminate, [22-3](#)
  - ODCIAggregateWrapContext, [22-4](#)
  - overview, [12-1](#)
- ODCIAggregateDelete, [12-7, 22-1](#)
- ODCIAggregateInitialize, [12-1, 22-2](#)
- ODCIAggregateIterate, [12-1, 22-2](#)
- ODCIAggregateMerge, [12-2, 22-3](#)
- ODCIAggregateTerminate, [12-2, 22-3](#)
- ODCIAggregateWrapContext, [12-6, 22-4](#)
- ODCIGetInterfaces method, [15-19](#)
- ODCIIndexClose method, [15-26](#)
- ODCIIndexCreate method, [15-20](#)
- ODCIIndexDelete method, [15-28](#)
- ODCIIndexDrop method, [15-21](#)
- ODCIIndexFetch method, [15-25](#)
- ODCIIndexGetMetadata method, [15-30](#)
- ODCIIndexInsert method, [15-27](#)
- ODCIIndexStart method, [15-22, 15-24](#)

ODCIIndexUpdate method, [15-28](#)

OID

with CREATE TYPE, [3-2](#)

operator, [7-5](#)

Oracle Extensibility Architecture, [1-1](#)

Oracle Multimedia, [1-3](#)

Oracle Spatial cartridge, [1-3](#)

Oracle Text, [1-3](#)

order methods, [3-4](#)

overview, [1, 1-1](#)

## P

---

packages

corruption, [4-6](#)

parallel aggregation and external context, [12-6](#)

Parallel evaluation of user-defined aggregates, [12-4](#)

PARAMETERS clause with external procedure, [5-8](#)

partitioning method

HASH, [13-18](#)

RANGE, [13-18](#)

PL/SQL

DBMS\_LOB package compared with OCI, [6-4](#)

debugging, [4-4](#)

demo directory, [18-2](#)

differences from C and C++, [4-5](#)

power demand cartridge example, [15-1](#)

demo file (extdemo1.sql), [15-12](#)

primary binding, [9-10](#)

## R

---

R-trees, [1-7](#)

REF operator, [1-5](#)

reference type, [1-5](#)

registering an external procedure, [5-3](#)

Restrictions on Callbacks, [5-10](#)

routine

service, [18-1](#)

RPC time out, [4-6, 5-11](#)

## S

---

schema

naming conventions, [2-4](#)

scope, [1-2](#)

scope of data cartridge, [1-2](#)

selectivity, [1-8](#)

SELF parameter, [4-3, 4-4](#)

service routine, [18-1](#)

examples, [18-1](#)

shared library, [5-1](#)  
  naming conventions, [2-5](#)  
signature, [9-1](#)  
signature mismatch, [4-5](#)  
statistics type  
  definition, [1-1](#)  
suggested development approach for data  
  cartridge, [2-10](#)

## T

---

table functions  
  parallel execution of, [13-5](#), [13-15](#)  
  partitioning input, [13-18](#)  
  pipelined, [13-3](#), [13-6](#), [13-7](#)  
  querying, [13-13](#)  
tables  
  index-organized, [7-5](#)  
termination, ODCIAggregate, [12-2](#)  
transient types  
  See ANYTYPE type  
triggers

triggers (*continued*)  
  with LOBs, [6-11](#)

## U

---

USER\_INDEXTYPE\_COMMENTS view, [8-8](#)  
user-defined operator, [9-1](#)  
user-defined type, [1-4](#)

## V

---

view  
  ALL\_INDEXTYPE\_COMMENTS, [8-8](#)  
  DBA\_INDEXTYPE\_COMMENTS, [8-8](#)  
  DBA\_SECONDARY\_OBJECTS, [8-13](#)  
  USER\_INDEXTYPE\_COMMENTS, [8-8](#)

## W

---

WITH CONTEXT clause and external procedure,  
  [5-9](#)